



Associated  
Engineering

GLOBAL PERSPECTIVE.  
LOCAL FOCUS.

Town of Virden

# ENVIRONMENT ACT PROPOSAL

For a New Wastewater Treatment Facility in Virden, Manitoba



*Prepared for:*

**The Town of Virden  
and The Manitoba Water Services Board**



January 8, 2014



*Prepared By:*

Associated Engineering (Sask.) Ltd.  
203 - Number Five Donald Street  
Winnipeg, Manitoba R3L 2T4

AE Project No. 2013-4246.000

EGE Engineering Ltd.  
511 Pepperloaf Crescent  
Winnipeg, Manitoba R3R 1E6

EGE Project No. 0137-001-01



#### **CONFIDENTIALITY AND © COPYRIGHT**

This document is for the sole use of the addressee and Associated Engineering (Sask.) Ltd. The document contains proprietary and confidential information that shall not be reproduced in any manner or disclosed to or discussed with any other parties without the express written permission of Associated Engineering (Sask.) Ltd. Information in this document is to be considered the intellectual property of Associated Engineering (Sask.) Ltd. in accordance with Canadian copyright law.

This report was prepared by Associated Engineering (Sask.) Ltd. for the account of Town of Virden The Manitoba Water Services Board. The material in it reflects Associated Engineering (Sask.) Ltd.'s best judgement, in the light of the information available to it, at the time of preparation. Any use which a third party makes of this report, or any reliance on or decisions to be made based on it, are the responsibility of such third parties. Associated Engineering (Sask.) Ltd. accepts no responsibility for damages, if any, suffered by any third party as a result of decisions made or actions based on this report.

# Environment Act Proposal Form

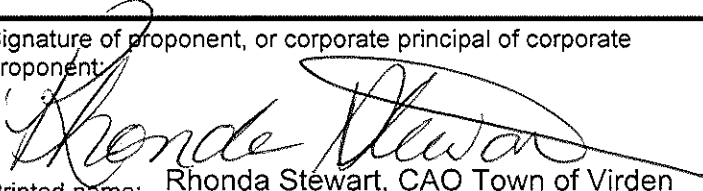

Name of the development: Town of Virden Wastewater Treatment Plant Upgrades	
Type of development per Classes of Development Regulation (Manitoba Regulation 164/88): Class 2 - Sewage Treatment Plant	
Legal name of the proponent of the development: Town of Virden	
Location (street address, city, town, municipality, legal description) of the development: Lot 13, Block 170, Plan 197 (BLTO)	
Name of proponent contact person for purposes of the environmental assessment: Ken Anderson, P.Eng.	
Phone: 204-942-6391 Fax: 204-942-6399	Mailing address: 203 - 5 Donald Street Winnipeg, MB R3L 2T4
Email address: andersonk@ae.ca	
Webpage address:	
Date: January 6, 2014	Signature of proponent, or corporate principal of corporate proponent:  Printed name: Rhonda Stewart, CAO Town of Virden



A complete **Environment Act Proposal (EAP)** consists of the following components:

- **Cover letter**
- **Environment Act Proposal Form**
- **Reports/plans supporting the EAP** (see "Information Bulletin - Environment Act Proposal Report Guidelines" for required information and number of copies)
- **Application fee** (Cheque, payable to Minister of Finance, for the appropriate fee)

**Submit the complete EAP to:**

Director  
Environmental Approvals Branch  
Manitoba Conservation and Water Stewardship  
Suite 160, 123 Main Street  
Winnipeg, Manitoba R3C 1A5

**For more information:**

Phone: (204) 945-8321  
Fax: (204) 945-5229  
<http://www.gov.mb.ca/conservation/eal>

Per Environment Act Fees Regulation (Manitoba Regulation 168/96):	
Class 1 Developments	\$500
Class 2 Developments	\$5,000
Class 3 Developments:	
Transportation and Transmission Lines	\$5,000
Water Developments	\$50,000
Energy and Mining	\$100,000

ENVIRONMENT ACT PROPOSAL  
TOWN OF VIRDEN WASTEWATER TREATMENT FACILITY UPGRADES

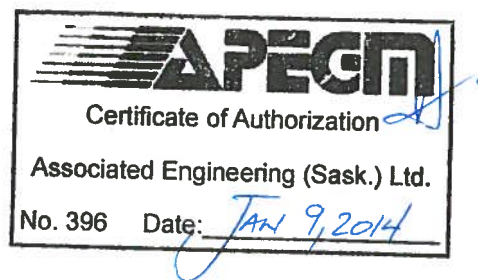

Prepared by Associated Engineering (Sask.) Ltd.  
&  
EGE Engineering Ltd.

## TABLE OF CONTENTS

<b>1.0</b>	<b>INTRODUCTION AND BACKGROUND .....</b>	<b>1</b>
1.1	PROJECT SCOPE .....	1
1.2	BACKGROUND .....	1
1.2.1	Current Environmental License.....	2
1.2.2	Proposed Effluent Quality Criteria.....	2
1.3	REGULATORY PROCESS.....	3
<b>2.0</b>	<b>PROJECT DESCRIPTION .....</b>	<b>4</b>
2.1	PROJECT LOCATION .....	4
2.1.1	Certificate of Title.....	4
2.1.2	Land Ownership .....	5
2.1.3	Existing Land Use.....	5
2.2	EXISTING VIRDEN WASTEWATER TREATMENT PLANT.....	5
2.2.1	Existing Wastewater Treatment Process.....	7
2.2.2	Condition of Existing Facilities.....	8
2.3	ASSESSMENT OF WASTEWATER TREATMENT ALTERNATIVES .....	9
2.3.1	Primary Treatment Design.....	9
2.3.2	Secondary Treatment Design .....	10
2.3.2.1	<i>Extended Aeration with Alum Addition.....</i>	<i>10</i>
2.3.2.2	<i>Sequencing Batch Reactor with Alum Addition.....</i>	<i>11</i>
2.3.2.3	<i>Membrane Bioreactor with Alum Addition.....</i>	<i>12</i>
2.3.2.4	<i>Recommended Alternative.....</i>	<i>12</i>
2.3.3	Disinfection Alternatives.....	13
2.4	VIRDEN WASTEWATER TREATMENT FACILITY UPGRADE PROJECT .....	14
2.4.1	Phasing of the Works.....	15
2.4.1.1	<i>Interim Treatment Objectives .....</i>	<i>15</i>
2.4.2	Design Criteria.....	17
2.4.2.1	<i>Design Year and Population.....</i>	<i>17</i>
2.4.2.2	<i>Effluent Criteria.....</i>	<i>18</i>
2.4.2.3	<i>Design Flows .....</i>	<i>18</i>
2.4.2.4	<i>Design Contaminant Loadings .....</i>	<i>19</i>
2.4.2.5	<i>Wastewater Design Temperature.....</i>	<i>20</i>
2.4.3	Plant Site Components.....	20
2.4.4	Process Mechanical.....	22
2.4.4.1	<i>Pumping Station Upgrade.....</i>	<i>22</i>
2.4.4.2	<i>Force Main Upgrades .....</i>	<i>22</i>
2.4.4.3	<i>Septage Receiving Station.....</i>	<i>22</i>

2.4.4.4	Headworks.....	23
2.4.4.5	Sequencing Batch Reactors.....	27
2.4.4.6	Effluent Disinfection.....	31
2.4.4.7	Biosolids Treatment.....	35
2.4.4.8	Chemical Dosing.....	39
2.4.5	Phase I Works Interim Equipment.....	40
2.4.5.1	Interim Primary Treatment.....	40
2.4.5.2	Interim Disinfection Equipment.....	40
2.4.6	Civil Works.....	40
2.4.6.1	Geotechnical Investigation.....	41
2.4.6.2	Access Road and Parking.....	41
2.4.6.3	Drainage.....	41
2.4.6.4	Outfall Alignment.....	41
2.4.7	Structural Works.....	42
2.4.7.1	Headworks Building.....	42
2.4.7.2	Sequencing Batch Reactors, Equalization Tanks and UV Disinfection.....	43
2.4.7.3	Aerobic Digester.....	43
2.4.7.4	Sludge Holding Tank.....	43
2.4.7.5	Sludge Pumping Station.....	43
2.4.7.6	Blower and Control Room Building.....	43
2.4.7.7	Existing Facility Retrofits.....	44
2.4.8	Building Mechanical Systems.....	44
2.4.8.1	Utilities.....	44
2.4.8.2	Plumbing.....	44
2.4.8.3	Heating, Ventilation and Cooling.....	45
2.4.8.4	Odour Control.....	46
2.4.8.5	Fire Protection.....	46
2.4.9	Electrical Systems.....	46
2.4.9.1	Hazardous Area Classification.....	46
2.4.9.2	Service Requirements.....	46
2.4.9.3	Standby Power.....	47
2.4.9.4	Surge Protection.....	47
2.4.9.5	Lighting.....	47
2.4.10	Instrumentation and Controls.....	47
2.4.10.1	Controls Architecture.....	47
2.4.10.2	Alarms.....	48
2.4.10.3	SCADA.....	48
2.4.10.4	HMI.....	48
2.4.11	Construction.....	48
2.4.11.1	Commissioning.....	48
2.4.11.2	Phase II Works.....	49
2.4.12	Decommissioning.....	49
2.5	PROJECT SCHEDULE.....	50
2.6	FUNDING.....	50

2.6.1	Phase I Works.....	50
2.6.2	Phase II Works.....	50
2.7	PUBLIC CONSULTATION .....	51
<b>3.0</b>	<b>ASSESSMENT APPROACH .....</b>	<b>52</b>
3.1	GEOGRAPHIC BOUNDARIES .....	52
3.2	TEMPORAL BOUNDARIES .....	52
3.3	ENVIRONMENTAL COMPONENTS .....	52
3.4	PROJECT-ENVIRONMENT INTERACTION .....	53
3.5	MITIGATION MEASURES.....	53
3.6	SIGNIFICANCE OF RESIDUAL ADVERSE EFFECTS .....	56
<b>4.0</b>	<b>ENVIRONMENTAL SETTING.....</b>	<b>58</b>
4.1	PHYSICAL ENVIRONMENT .....	58
4.1.1	Air Quality.....	58
4.1.2	Climate.....	58
4.1.3	Physiography and Landscape.....	59
4.1.3.1	Topography.....	59
4.1.3.2	Geology.....	60
4.1.3.3	Soils .....	61
4.1.4	Surface Water .....	62
4.1.4.1	Surface Water Quality.....	71
4.1.4.2	Surface Water Allocation.....	75
4.1.4.3	Hydrogeology and Groundwater.....	76
4.2	TERRESTRIAL ENVIRONMENT.....	79
4.2.1	Vegetation.....	79
4.2.2	Wildlife .....	81
4.2.3	Protected Species .....	84
4.3	AQUATIC RESOURCES AND HABITAT .....	85
4.4	SOCIO-ECONOMIC ENVIRONMENT .....	87
4.4.1	Land Use.....	89
4.4.2	Transportation.....	90
4.5	HERITAGE AND CULTURAL RESOURCES .....	91
4.6	FIRST NATIONS .....	92

<b>5.0 ENVIRONMENTAL EFFECTS AND MITIGATION.....</b>	<b>95</b>
5.1 INTRODUCTION.....	95
5.2 PHYSICAL ENVIRONMENT .....	95
5.2.1 Air Quality.....	95
5.2.1.1 Construction .....	95
5.2.1.2 Operation.....	95
5.2.1.3 Mitigation Measures.....	96
5.2.1.4 Residual Effects after Mitigation .....	97
5.2.2 Noise.....	97
5.2.2.1 Construction .....	97
5.2.2.2 Operation.....	97
5.2.2.3 Mitigation Measures.....	98
5.2.2.4 Residual Effects after Mitigation .....	98
5.2.3 Climate.....	98
5.2.3.1 Construction .....	98
5.2.3.2 Operation.....	98
5.2.3.3 Mitigation Measures.....	99
5.2.3.4 Residual Effects after Mitigation .....	99
5.2.4 Geology.....	100
5.2.4.1 Construction .....	100
5.2.4.2 Operation.....	100
5.2.4.3 Mitigation Measures.....	100
5.2.4.4 Residual Effects after Mitigation .....	100
5.2.5 Soils.....	100
5.2.5.1 Construction .....	100
5.2.5.2 Operation.....	101
5.2.5.3 Mitigation Measures.....	101
5.2.5.4 Residual Effects after Mitigation .....	102
5.2.6 Groundwater.....	102
5.2.6.1 Construction .....	102
5.2.6.2 Operation.....	102
5.2.6.3 Mitigation Measures.....	103
5.2.6.4 Residual Effects after Mitigation .....	103
5.2.7 Surface Water Quality.....	103
5.2.7.1 Construction .....	103
5.2.7.2 Operation.....	104
5.2.7.3 Mitigation Measures.....	105
5.2.7.4 Residual Effects after Mitigation .....	105
5.3 TERRESTRIAL ENVIRONMENT.....	106
5.3.1 Vegetation.....	106
5.3.1.1 Construction .....	106
5.3.1.2 Operation.....	106
5.3.1.3 Mitigation Measures.....	106



5.3.1.4	<i>Residual Effects after Mitigation</i> .....	106
5.3.2	Wildlife .....	107
5.3.2.1	<i>Construction</i> .....	107
5.3.2.2	<i>Operation</i> .....	107
5.3.2.3	<i>Mitigation Measures</i> .....	107
5.3.2.4	<i>Residual Effects after Mitigation</i> .....	107
5.4	AQUATIC RESOURCES AND HABITAT .....	107
5.4.1	Fish and Fish Habitat.....	107
5.4.1.1	<i>Construction</i> .....	107
5.4.1.2	<i>Operation</i> .....	108
5.4.1.3	<i>Mitigation Measures</i> .....	109
5.4.1.4	<i>Residual Effects after Mitigation</i> .....	109
5.5	SOCIO-ECONOMIC ENVIRONMENT .....	109
5.5.1	Land and Resource Use .....	109
5.5.1.1	<i>Construction</i> .....	109
5.5.1.2	<i>Operation</i> .....	109
5.5.1.3	<i>Mitigation Measures</i> .....	109
5.5.1.4	<i>Residual Effects after Mitigation</i> .....	109
5.5.2	Transportation.....	110
5.5.2.1	<i>Construction</i> .....	110
5.5.2.2	<i>Operation</i> .....	110
5.5.2.3	<i>Mitigation Measures</i> .....	110
5.5.2.4	<i>Residual Effects after Mitigation</i> .....	110
5.5.3	Recreation and Tourism.....	111
5.5.3.1	<i>Construction</i> .....	111
5.5.3.2	<i>Operation</i> .....	111
5.5.3.3	<i>Mitigation Measures</i> .....	111
5.5.3.4	<i>Residual Effects after Mitigation</i> .....	111
5.6	HERITAGE AND CULTURAL RESOURCES .....	111
5.6.1	Construction.....	111
5.6.2	Operation .....	111
5.6.3	Mitigation Measures.....	111
5.6.4	Residual Effects after Mitigation.....	112
<b>6.0</b>	<b>ACCIDENTS AND MALFUNCTIONS .....</b>	<b>113</b>
6.1	FIRE .....	113
6.2	SPILLS .....	114
6.3	EQUIPMENT MALFUNCTION.....	115
6.4	TRANSPORTATION ACCIDENTS.....	115

<b>7.0</b>	<b>EFFECTS OF THE ENVIRONMENT ON THE PROJECT .....</b>	<b>116</b>
7.1	SEVERE WEATHER .....	116
7.2	FLOOD .....	116
7.3	DROUGHT .....	116
7.4	SEISMIC ACTIVITY .....	116
<b>8.0</b>	<b>MONITORING AND FOLLOW-UP .....</b>	<b>117</b>
<b>9.0</b>	<b>CONCLUSION.....</b>	<b>118</b>
<b>10.0</b>	<b>REFERENCES.....</b>	<b>119</b>

## **TABLES (in Text)**

Table 1-1 - Existing Virden WWTP - Current Liquid Stream Effluent Requirements
Table 1-2 - Virden WWTF Upgrade Project - Effluent Design Requirements
Table 1-3 - Virden WWTF Upgrade Project - Effluent Total Ammonia Design Requirements
Table 2-1 - Liquid Stream Treatment Summary
Table 2-2 - Design Wastewater Flows
Table 2-3 - Comparison of Projected and Actual Contaminant Loadings
Table 2-4 - Design Criteria for Automatic Screens
Table 2-5 - Design Specifications for Automatic Screens
Table 2-6 - Design Criteria for Grit Removal System
Table 2-7 - Design Specifications for Grit Removal System
Table 2-8 - Design Criteria for Sequencing Batch Reactors
Table 2-9 - Design Specifications for Sequencing Batch Reactors
Table 2-10 - Design Criteria for Waste Activated Sludge Pumps
Table 2-11 - Design Criteria for UV Disinfection System
Table 2-12 - Design Specifications for UV Disinfection System
Table 2-13 - Design Criteria for Effluent Reuse Pipes
Table 2-14 - Design Specifications for Effluent Reuse Pipes
Table 2-15 - Design Criteria for Parshall Flume
Table 2-16 - Design Criteria for Aerobic Digester
Table 2-17 - Design Specifications for Aerobic Digester
Table 2-18 - Design Criteria for Screw Press
Table 2-19 - Design Specifications for Screw Press
Table 2-20 - Ventilation Requirements
Table 2-21 - Virden WWTF Upgrade Project Schedule
Table 3-1 - Potential Project-Environment Interaction Matrix
Table 3-2 - Assessment of Environmental Effects and Determination of Significance
Table 3-3 - Combination of Factors to Determine Significance of Residual Effects
Table 4-1 - Ambient Air Quality for the Brandon Area
Table 4-2 - Canadian Climate Normals 1981-2005) - Virden, Manitoba
Table 4-3 - Monthly Mean Discharge (m <sup>3</sup> /s) - Bosshill Creek near Virden (05MG002) 1959 to 1976
Table 4-4 - Monthly Mean Discharge (m <sup>3</sup> /s) - Gopher Creek near Virden (05MG003) 1959 to 2011
Table 4-5 - Monthly Mean Discharge (m <sup>3</sup> /s) - Assiniboine River near Miniota (05ME006) 1961 to 2011
Table 4-6 - Surface Water Quality Upstream and Downstream of Virden WWTP Effluent Discharge
Table 4-7 - Groundwater Wells and Use

**PLATES (in Text)**

- Plate 2-1 - Lot and Block plan showing existing Virden WWTP and Virden WWTF Upgrade Project
- Plate 2-2 - Phase I and Phase II works for the Virden WWTF Upgrade Project
- Plate 2-3 - Schematic showing the location of Virden WWTF Phase I and Phase II project components
- Plate 2-4 - New Virden WWTF and existing WWTP location
- Plate 4-1 - Elevation profile of Gopher Creek from drainage channel outfall to Assiniboine River
- Plate 4-2 - CLI Soil Capability for Agriculture in the Virden area
- Plate 4-3 - Arrow-Oak River Watershed boundary
- Plate 4-4 - Location of hydrometric monitoring stations near Virden WWTF
- Plate 4-5 - Control structure and artificial wetland on Bosshill Creek at PR 257
- Plate 4-6 - Surface water quality sampling locations for existing Virden WWTP effluent discharge
- Plate 4-7 - Location of water well records search near Virden WWTF
- Plate 4-8 - CLI Land Capability for Forestry in the Virden area
- Plate 4-9 - CLI Land Capability for Waterfowl in the Virden area
- Plate 4-10 - CLI Land Capability for Ungulates in the Virden area
- Plate 4-11 - Distribution of threatened and endangered species in Arrow-Oak River Watershed
- Plate 4-12 - Gopher Creek crossing located in SW 26-10-26 W1M
- Plate 4-13 - CLI Watershed Capability for Sport Fish in the Virden area
- Plate 4-14 - CLI Land Capability for Recreation in the Virden area
- Plate 4-15 - Location of First Nations near the Virden WWTF project site

## **PHOTOS (in Text)**

- Photo 2-1 - North elevation of existing Virden WWTP
- Photo 2-2 - Southwest elevation of existing Virden WWTP
- Photo 2-3 - South elevation of existing Virden WWTP
- Photo 2-4 - End-of-pipe discharge of treated effluent from existing Virden WWTP into the surface drainage channel
- Photo 4-1 - Bosshill Creek at PR 257 crossing
- Photo 4-2 - Bosshill Creek at PR 257 crossing
- Photo 4-3 - Outlets from control structure on Bosshill Creek north of PR 257
- Photo 4-4 - Inlet culverts on Bosshill Creek
- Photo 4-5 - Artificial wetland (Ducks Unlimited)
- Photo 4-6 - Dyke at south end of wetland
- Photo 4-7 - Upstream, Gopher Creek at 05MG003
- Photo 4-8 - Downstream, Gopher Creek at 05MG003
- Photo 4-9 - Upstream, Gopher Creek at PTH 83
- Photo 4-10 - Downstream, Gopher Creek at PTH 83
- Photo 4-11 - Upstream, Gopher Creek at PR257 in Virden
- Photo 4-12 - PR 257 bridge at Gopher Creek in Virden
- Photo 4-13 - Effluent drainage channel looking downstream from end-of-pipe
- Photo 4-14 - Effluent drainage channel about 50 m downstream of end-of-pipe
- Photo 4-15 - Effluent drainage channel looking upstream, about 125 m from end-of-pipe
- Photo 4-16 - Discharge from effluent drainage channel into Gopher Creek
- Photo 4-17 - Gopher Creek, looking upstream from effluent drainage channel outlet
- Photo 4-18 - Gopher Creek, downstream from effluent drainage channel outlet
- Photo 4-19 - Gopher Creek, looking upstream from PTH 1 south service road (545 m from outlet)
- Photo 4-20 - Gopher Creek, looking at PTH 1 south service road crossing
- Photo 4-21 - Gopher Creek at north TCH service road crossing, looking west (700 m from outlet)
- Photo 4-22 - Gopher Creek, looking at ford crossing north of PTH 1 service road
- Photo 4-23 - Gopher Creek, looking downstream, approximately 3.1 km downstream of the effluent drainage channel outlet
- Photo 4-24 - Vegetation along the north side of the Virden WWTF project site
- Photo 4-25 - Vegetation on vacant lot east of the Virden WWTF project site
- Photo 4-26 - Typical riparian vegetation along Gopher Creek immediately downstream of the effluent drainage channel outlet
- Photo 4-27 - Typical riparian vegetation north of TCH adjacent to agricultural areas
- Photo 4-28 - Typical pattern of land use for forage crop production around stands of aspen and oak
- Photo 4-29 - Nests located 335 m southeast of the project site near Gopher Creek
- Photo 4-30 - Nests located 335 m southeast of the project site near Gopher Creek

**FIGURES (Following Text)**

Figure 01 - Location Plan  
Figure 02 - Site Plan  
Figure 03 - Surrounding Land Use

**APPENDICES (Following Text)**

Appendix A - Clean Environment Commission Order No. 1110  
Appendix B - Certificate of Title  
Appendix C - Functional Design Drawings  
Appendix D - Public Open House Information  
Appendix E - Manitoba Water Well Drillers Records  
Appendix F - Manitoba Conservation Data Centre Species of Conservation Concern

## 1.0 INTRODUCTION AND BACKGROUND

Associated Engineering (Sask.) Ltd. (AE) and EGE Engineering Ltd. (EGE) have prepared the following Environment Act Proposal (EAP) for the Virден Wastewater Treatment Facility (WWTF) Upgrade Project (the Project). The EAP is based on the 90% draft Functional Design Report prepared by AE in October 2013.

### 1.1 PROJECT SCOPE

The Town of Virден (Town), with assistance from the Manitoba Water Services Board (MWSB), is proceeding with the development of a new wastewater treatment facility that will provide greater treatment capacity and a higher level of treatment than currently exists. The Town has identified a need for the new facility to replace the aging existing mechanical wastewater treatment plant (WWTP) and solids disposal infrastructure.

The new WWTF is intended to:

- Provide liquid stream treatment so that effluent quality meets the criteria set forth and reviewed with Manitoba Conservation and the Canadian regulations that govern treated effluent discharge;
- Provide solids stream treatment so that the biosolids can be transported to the Town of Virден landfill facility for final disposal. Eventually the Town will move towards sustainable biosolids recycling (land application, composting, etc.);
- Include sufficient redundancy so that routine maintenance and upgrades can be performed on the system. This equates to 60% of the process flow rate;
- Be operable by Town staff and have technology that can be supported within the local region; and
- Include spatial provisions for future upgrades.

### 1.2 BACKGROUND

For several years, the Town has been preparing to upgrade the existing WWTP, with a new facility, as the existing plant has been unable to meet its environmental requirements and is in very poor condition. A recent process failure at the WWTP has made the situation more urgent in terms of upgrading the plant.

In 2008, the Town authorized a feasibility study to assess options for upgrading the facility and in 2013 the Town authorized an update to the previously completed feasibility study. The Updated Feasibility Study <sup>(1)</sup> which was prepared by AE, and submitted to the MWSB and the Town in July 2013, recommended a Sequencing Batch Reactor Process (SBR) as the main treatment process, with ultraviolet (UV) disinfection and aerobic digestion with biosolids dewatering.

Following affirmation of the Updated Feasibility Study recommendation, a Functional Design Study for the new WWTF was undertaken by AE in order to define the project. The 90% draft of this Functional Design Study <sup>(2)</sup> forms the basis for this Environment Act Proposal.

### 1.2.1 Current Environmental License

The existing Virden WWTP is operating under Clean Environment Commission Order No. 1110, issued on December 19, 1986. A copy of the order is included in Appendix A. Table 1-1 summarizes the current effluent discharge requirements listed in Order No. 1110.

**Table 1-1  
 Existing Virden WWTP - Current Liquid Stream Effluent Requirements**

Parameter	Value
5-day Biological Oxygen Demand (BOD <sub>5</sub> )	≤ 30 mg/L
Non-Filterable Residue Content of Effluent	≤ 30 mg/L
Fecal Coliform	≤ 200 MPN / 100 mL

### 1.2.2 Proposed Effluent Quality Criteria

Manitoba Conservation regulates the discharge of treated effluent in Manitoba, as legislated in the *Public Health Act* (P210). A formal discussion was held between AE and Manitoba Conservation as part of the Updated Feasibility Study completed in 2013. The meeting was used to establish draft effluent quality requirements for the design of the Virden WWTF Upgrade Project. The draft effluent quality requirements were set at values that would ensure the effluent discharge from the new WWTF would meet the Manitoba Water Quality Standards, Objectives and Guidelines (MWQSOG), November 2011 <sup>(3)</sup>. The draft effluent quality requirements for the Virden WWTF Upgrade Project, as drafted by Manitoba Conservation and AE, are listed in Tables 1-2 and 1-3 below.

**Table 1-2  
 Virden WWTF Upgrade Project - Effluent Design Requirements**

Parameter	Value
5-day Biological Oxygen Demand (BOD <sub>5</sub> )	≤ 25 mg/L <sup>(1)</sup>
Total Suspended Solids (TSS)	≤ 25 mg/L <sup>(1)</sup>
Total Phosphorus (TP) <sup>1</sup>	≤ 1 mg/L <sup>(2)</sup>
Ammonia (NH <sub>3</sub> -N)	See Table 1-3 below
Fecal Coliform	≤ 200 MPN / 100 mL <sup>(3)</sup>
<i>Escherichia Coli</i> ( <i>E.coli</i> )	≤ 200 MPN / 100 mL <sup>(3)</sup>

<sup>(1)</sup> Not to exceed maximum concentrations

<sup>(2)</sup> Based on 30-day rolling average

<sup>(3)</sup> Based on 30-day geometric mean



**Table 1-3**  
**Virden WWTF Upgrade Project - Effluent Total Ammonia Design Requirements**

Effluent pH	Total Ammonia (mg/L)	Effluent pH	Total Ammonia (mg/L)
6.50	48.83	7.80	12.14
6.60	46.84	7.90	10.13
6.70	44.57	8.00	8.41
6.80	42.00	8.10	6.95
6.90	39.16	8.20	5.73
7.00	36.09	8.30	4.71
7.10	32.86	8.40	3.88
7.20	29.54	8.50	3.20
7.30	26.21	8.60	2.65
7.40	22.97	8.70	2.20
7.50	19.89	8.80	1.84
7.60	17.03	8.90	1.56
7.70	14.44	9.00	1.32

### 1.3 REGULATORY PROCESS

This report has been prepared in accordance with *The Environment Act* (E125) and the *Licensing Procedures Regulation* (Manitoba Regulation 163/88) to obtain an Environment Act License for the Project. Under the *Classes of Development Regulation* (Manitoba Regulation 164/88) the WWTF Upgrade Project is classified as a Class 2 Development, as it meets the definition of a sewage treatment plant under Section 3(7) Waste Treatment and Storage.

## **2.0 PROJECT DESCRIPTION**

This section describes the Virden WWTF Upgrade Project and provides information on the project location, the state of the existing facilities, the assessment of design alternatives for the new WWTF, and the functional design for the project.

### **2.1 PROJECT LOCATION**

The Town of Virden is located on the Trans-Canada Highway approximately 280 kilometers (km) west of Winnipeg, Manitoba (see Figure 01 for a location plan). Figure 02 provides a site plan of the current Virden WWTP and future WWTF Upgrade project and Figure 03 illustrates the surrounding land use. The Town's economy consists of primarily light commercial activities mainly in support of the surrounding agricultural areas, as well as service and support to the petroleum producing fields adjacent and to the southwest of the Town. There are no large industries in the Town. The population based upon the 2011 census is 3,114 persons.

#### **2.1.1 Certificate of Title**

The certificate of title for the existing Virden WWTP and site of the proposed WWTF Upgrade is provided in Appendix B. The existing WWTP and the proposed WWTF Upgrade are located on the same parcel of land, described as Lot 13, Block 170, Plan 197, held in the Brandon Land Titles Office (BLTO). The Town of Virden is the owner of the property under the following title:

- Title No. 243173/2, registered to the Town of Virden, and including: Lots 6, 7, 11, 12 and 13, Block 170, Plan 197 BLTO, excluding out of Lot 7 the southeasterly 38.8 feet and out of Lots 7, 11, 12 and 13, the public lane (Plan 27609 BLTO) in the easterly half of 22-10-26 WPM.

Plate 2-1 provides the lot and block plan for the Virden WWTF project site.

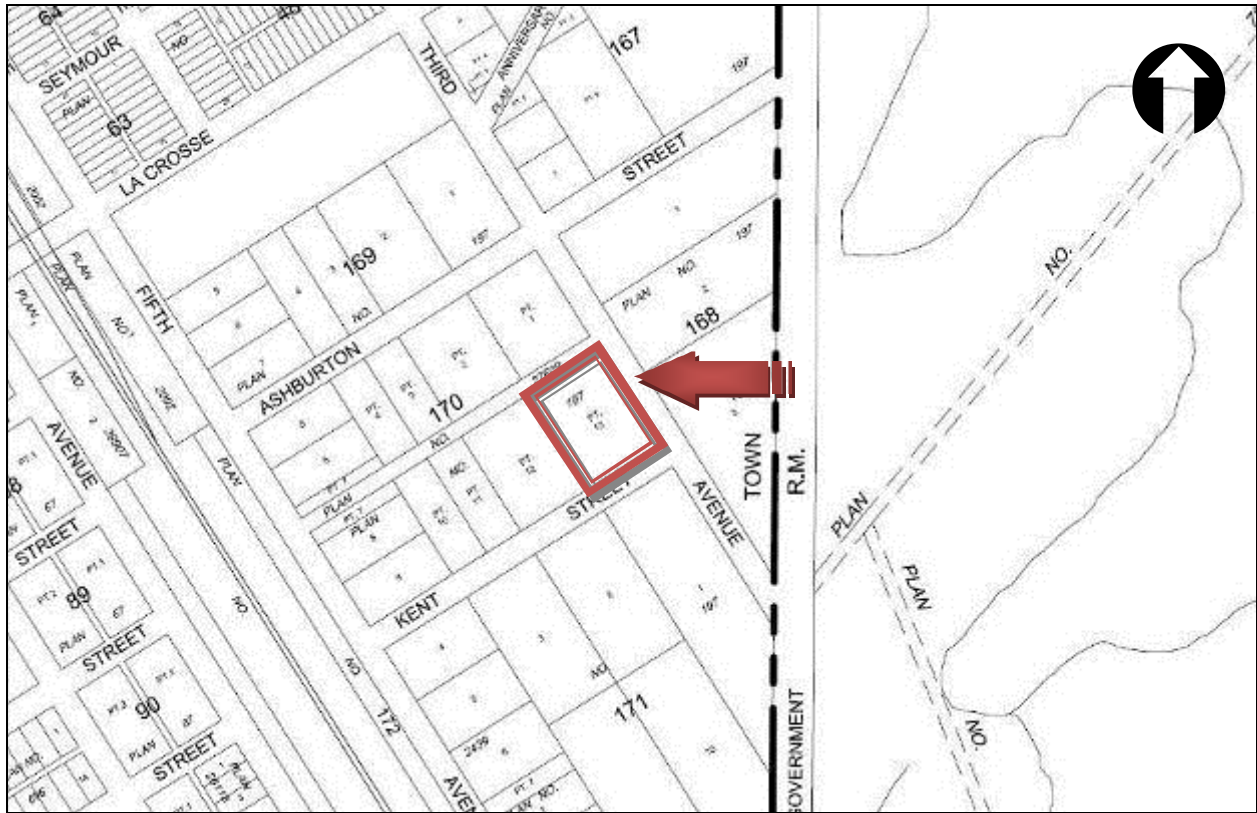

Plate 2-1: Lot and block plan showing existing Virден WWTP and Virден WWTF Upgrade Project.

### 2.1.2 Land Ownership

The Town of Virден is the registered owner of the land containing the Virден WWTP and the site of the WWTF Upgrade Project.

### 2.1.3 Existing Land Use

The project site is currently zoned for industrial land use ML. Surrounding land use is shown on Figure 03.

## 2.2 EXISTING VIRDEN WASTEWATER TREATMENT PLANT

Domestic wastewater from the Town is collected and conveyed to a mechanical wastewater treatment plant located on Third Avenue between Kent and Ashburn Streets, in the southeast part of Virден. This treatment plant, which was constructed in 1979, replaced an earlier primary treatment facility located approximately one block west on Fifth Avenue. Figure 02 provides a site plan of the existing Virден WWTP. Representative photographs of the existing WWTP are provided below.



*Photo 2-1: North elevation of existing Virден WWTP.*



*Photo 2-2: Southwest elevation of existing Virден WWTP.*



*Photo 2-3: South elevation of existing Virден WWTP.*

### **2.2.1 Existing Wastewater Treatment Process**

The original plant consisted of a surge tank, bar screen, one deep shaft (aeration reactor), three floatation secondary clarifiers, and chlorine disinfection. The surge tank is plugged and corroded, and has been bypassed. In April 2012, the deep shaft failed (plugged) and could not be feasibly restored, and is also off-line. The piping to the floatation tanks has also been plugged and seized, and the operation of these tanks has been modified by reversing the flow path through the units so they act like sedimentation tanks to maintain minimal treatment. Chlorine disinfection is also still maintained, via gas chlorine.

Currently, wastewater generated in the Town is collected at one lift station and pumped directly to the Virден WWTP. The wastewater discharges into the grit channel, where heavier material like rocks and grit are removed. After grit removal, alum is dosed prior to the converted sedimentation tanks to promote chemically enhanced primary treatment (CEPT), which promotes better solids removal, thus reducing total suspended solids (TSS) and biological oxygen demand (BOD). However, because the three converted sedimentation tanks are not ideal primary treatment, the removal efficiencies are not as optimal as a properly designed primary sedimentation system.

The sludge that settles in the sedimentation tanks is periodically removed by a vacuum truck and disposed of at drying beds located at the Town's landfill site, with ultimate disposal in the landfill. Prior to the deep shaft failure, the treatment process was challenged to meet effluent water quality requirements. After the failure of the deep shaft, the system is even more challenged. The implementation of CEPT at the plant is not ideal, and the effluent is currently not in compliance with water quality effluent guidelines for TSS, BOD and fecal coliforms. The effluent from the sedimentation tanks is dosed with chlorine for

disinfection purposes. The chlorine is dosed at a rate that is adequate to achieve a trace chlorine residual at the end of outfall pipe and non-measurable chlorine residual at the discharge point to Gopher Creek, which in turn discharges into the Assiniboine River.

The effluent from the sedimentation tanks flows by gravity into an outfall pipe that discharges into a ditch northeast of the plant. The ditch flows for about 175 m before it enters Gopher Creek, which is located 225 m northeast of the current WWTP building. Gopher Creek flows northeast, then southeast, then north before it discharges into the Assiniboine River. The total distance from the end of the effluent discharge channel (at Gopher Creek) to the Gopher Creek discharge into the Assiniboine River is 13.1 km.



*Photo 2-4: End-of-pipe discharge of treated effluent from existing Virден WWTP into the surface drainage channel.*

### **2.2.2 Condition of Existing Facilities**

The condition of the existing treatment equipment is poor, with some equipment, like the surge tank and deep shaft, no longer functioning. The poor condition is mostly due to the age of the equipment, which has surpassed its useful life, and also due to the previous years of poor ventilation within the plant that has resulted in excessive corrosion of much of the metal that is part of the equipment.

The building structure itself appears to be in good condition; however, detailed structural investigations have not been completed at the facility. Some of the mechanical heating, ventilation and air conditioning (HVAC) equipment has recently been replaced, which has significantly improved the air quality inside the building. In general, the remaining HVAC equipment is in poor condition primarily due to age.

The electrical system is in relatively good condition, but due to its age, will require upgrading as part of the project. The effluent outfall ditch that conveys the Virден WWTP effluent from the end of pipe to Gopher Creek has some build-up of debris likely due to a lack of screening at the plant.

## **2.3 ASSESSMENT OF WASTEWATER TREATMENT ALTERNATIVES**

There are a number of unit processes required to treat the liquid stream to achieve the discharge criteria drafted by Manitoba Conservation (Section 1.2.2). These liquid stream treatment (LST) unit processes include preliminary treatment (screening, grit removal, septage receiving), secondary treatment (biological process, chemical phosphorus removal and clarification) and disinfection. The Updated Feasibility Study completed in 2013 assessed several alternatives, mainly for secondary treatment and disinfection options. The assessment of alternatives is summarized below.

### **2.3.1 Primary Treatment Design**

The primary treatment processes required for the Virден WWTF Upgrade consist of an automatic fine screening unit, grit removal mechanisms and a septage receiving station all located in a common Headworks building. These preliminary treatment processes remove sand, gravel and other heavy materials that would not remain in suspension during secondary treatment, and would cause downstream operations and maintenance issues. Fine screens remove solids, like rags and wood, and the maximum spacing recommended in the Updated Feasibility Study was 6 mm. The final selection was dependent on the secondary treatment process (e.g. membrane based systems would require a much smaller spacing in the 1-2 mm range). The screening system would require a cleaning system and a container for storing screenings. The wet screening material would then be processed in a compactor, washed, dewatered and disposed in a storage bin for transportation to the landfill.

Grit removal would follow fine screening to remove solids with higher settling velocities, such as sand and gravel that can pass through the screen but potentially settle out in the secondary treatment process. Grit removal systems can be horizontal, aerated or vortex varieties. For the Virден WWTF Upgrade, a vortex grit removal system complete with a grit classifier to wash and dewater the accumulated grit was recommended. The grit material can be mixed with the screenings in the same bin for disposal at the landfill.

The Virден WWTF Upgrade is to be designed to accept septage from the Rural Municipality (R.M.) of Wallace. Septage is very high strength waste, so it is not advisable to directly discharge a truck load into the treatment system, as it can lead to process upsets. It is recommended to equalize the septage in an equalization tank and then use a pumping system to slowly feed the septage into the treatment process. There are a number of different package septage receiving stations available to the municipal market, and they can all provide similar treatment. These systems typically include a rock trap and screen prior to the septage entering an equalization tank. These systems can also be provided with a control panel that will assist in managing septage haulers access to the system and record the volumes discharged, which would aid in the billing process.

### 2.3.2 Secondary Treatment Design

The Updated Feasibility Study examined a number of secondary treatment technologies that would be suitable to upgrade the existing Virден WWTP to meet the effluent requirements drafted by Manitoba Conservation. The potential technologies included:

- Extended Aeration (EA);
- Sequencing Batch Reactor (SBR);
- Oxidation Ditches (OD);
- Moving Bed Bioreactor (MBBR);
- Membrane Bioreactor (MBR);
- Biological Aerated Filter (BAF);
- Facultative Lagoons (FL); and
- Rotating Biological Contactors (RBC).

From this list, a number of treatment processes were eliminated, as outlined below:

- Oxidation Ditches: This is a proven treatment technology, but this type of process requires a much larger area than other technologies that provide similar effluent quality;
- Moving Bed Bioreactor: There has been a recent interest in these types of facilities due to their compact footprint and the high quality effluent that is produced. There is limited experience in Canada with these treatment systems compared to other technologies that can achieve the effluent criteria required at the site;
- Biological Aerated Filters: These types of treatment systems can provide suitable treatment, but there are relatively few full-scale systems in Canada. However, the main concern is that due to the effluent total nitrogen (TN) criteria, a two-stage process is required to promote denitrification. This would mean additional tankage and equipment would be required for this second stage, which would be more costly compared with other treatment technologies;
- Facultative Lagoons: While this is a suitable technology, it is understood from previous investigations that the large land area required cannot be acquired in the Virден area due to the routing of oil and gas pipelines; and
- Rotating Biological Contactors: The need for nitrification and denitrification would mean that the number of units would increase, resulting in a relatively higher capital cost compared to other more compact treatment processes.

Three technologies were subsequently examined in greater detail: extended aeration; sequencing batch reactor; and membrane bioreactors. These are discussed in more detail below.

#### 2.3.2.1 Extended Aeration with Alum Addition

The extended aeration (EA) process is composed of a biological process tank followed by clarification. Screened and de-gritted wastewater flows by gravity to the biological process tank and is mixed with settled sludge that is being returned from the clarifiers. This mixture of wastewater and microorganism rich return sludge is referred to as mixed liquor. Anoxic tanks are located in the first portion of the



biological process tank and are used to promote denitrification. The mixed liquor overflows into the aerated portion of the biological process tank where carbonaceous BOD removal and nitrification occur. Blowers deliver air to diffusers located in the bottom of the process tank, which bubble air up through the mixed liquor to provide the oxygen required by the biological processes and also keep sludge in suspension in the aeration tanks. Alum is added for phosphorus removal at the downstream end of the biological process tank.

The mixed liquor then passes into the clarifiers where liquid is allowed to separate from the solids. The solids or sludge that is collected in the clarifier is either returned to the biological process tank as return activated sludge (RAS) or wasted as waste activated sludge (WAS) and pumped to the sludge treatment system. Effluent overflowing the secondary clarifier weirs is conveyed to the disinfection system.

EA processes are designed to provide a relatively long hydraulic retention time (HRT) in the aeration tank as well as a relatively long solids retention time (SRT). As a result of the relatively long HRT, larger aeration tanks are required and aeration energy use is higher than for high rate processes. However, this treatment process is a relatively simple design and is easy to operate. Another advantage of the longer HRT is an increased ability to provide buffering for treating shock loads. To some degree, the EA process provides for aerobic digestion of solids, and therefore, results in a lower sludge yield compared to other systems.

The construction cost for an extended aeration treatment system, with alum addition, was estimated to be \$14,375,273. The annual operations and maintenance (O&M) cost was estimated at \$57,818. The life cycle net present value (NPV) cost for the system, assuming a 30 year life cycle, 2% inflation, 5% interest and 5% salvage cost, was estimated at \$19,030,649.

### **2.3.2.2 Sequencing Batch Reactor with Alum Addition**

The sequencing batch reactor (SBR) is an activated sludge process that combines aeration and sludge settlement within the same tank. The major difference between SBR and EA activated sludge systems are that the SBR tank carries out the functions of equalization, aeration and sedimentation in a time sequence rather than in the conventional space sequence of continuous flow systems. This allows the SBR system to have a compact layout as the secondary clarifier is eliminated.

A SBR facility would include initial fine screening and grit removal to remove solids that could potentially damage downstream process equipment. Raw wastewater that has passed through the screens enters the SBR system. The SBR process is characterized by six discrete periods: anoxic fill; aerated fill; react; settle; decant; and idle. The number and lengths of anoxic and aerated cycles are adjusted to promote carbonaceous BOD removal, nitrification and denitrification. The settle cycle allows the separation of treated effluent from the sludge. The decant cycle follows and allows the treated effluent to pass into an equalization tank, while the sludge remains in the SBR tank. Alum is added for phosphorus removal either at the influent to the SBR or directly into the SBR process tank. In order to maintain the desired SRT during the idle phase, the sludge in the SBR process tanks is wasted as WAS and pumped to the sludge treatment process. Effluent that is decanted to the equalization tank is then pumped to the disinfection system.

The construction cost for a SBR treatment system with alum addition was estimated at \$11,905,300, with annual O&M costs of \$232,442. The life cycle NPV cost was estimated at \$16,131,674.

### **2.3.2.3 Membrane Bioreactor with Alum Addition**

Membrane bioreactors combine the activated sludge process with microfiltration or ultrafiltration membranes for liquid-solid separation. The membranes eliminate the requirement for secondary clarifiers. MBR systems are capable of operating at higher mixed liquor suspended solids (MLSS) concentrations than other treatment processes, such as EA or SBR. Consequently, MBR systems can operate with significantly smaller tanks than other processes and have a relatively small footprint.

An MBR facility would include initial fine screening and grit removal (typically through 1 mm diameter openings) to remove solids that could potentially damage downstream process equipment. Raw wastewater that has passed through the screens enters aerated equalization tanks that dampen flow rate variations so that a more constant flow can be delivered through the subsequent process. This is particularly important for the MBR process that has a maximum treatment rate based on membrane flux.

Effluent is pumped from the equalization tank into the anoxic zone (where denitrification occurs) and continues into the aerobic zone, where carbonaceous BOD removal and nitrification occur, and alum is added to precipitate phosphorus. Air bubbles delivered by air diffusers provide oxygen required for the biological processes and also generate mixing to keep the sludge in suspension. Membrane modules, which separate liquids and solids, are submerged in the aerobic zone and some of the sludge is recovered and returned to the anoxic tank as RAS, while another stream is wasted as WAS and pumped to the digesters. Effluent that passes through the membranes then flows through the disinfection system.

The construction cost for a MBR treatment system, with alum addition, was estimated at \$14,856,006, with annual O&M costs of \$239,462. The life cycle NPV cost was estimated at \$19,834,305.

### **2.3.2.4 Recommended Alternative**

Table 2-1 is a summary of the three main technologies reviewed in the Updated Feasibility Study. The table summarizes the pros and cons of each system, and the relative life cycle NPV costs.

**Table 2-1  
 Liquid Stream Treatment Summary**

Technology	Pro	Con	Life cycle Cost (NPV)
Extended Aeration	Well established process that is easy to operate	Largest footprint	\$19.0 M
	Robust process if there are varying flows and organic loads	Highest lifecycle cost	
	Gravity flow from headworks to outfall		
Sequencing Batch Reactors	Small footprint	High automation required access to a controls technician for O&M and troubleshooting	\$16.1 M
	Operational flexibility and control	Requires equalization and a final effluent pumping system	
	Lowest life cycle cost		
Membrane Bioreactors	Smallest footprint	High automation required access to a controls technician for O&M and troubleshooting	\$19.8 M
	Can achieve the highest effluent quality	Requires finer screening system	
		Membranes require periodic cleaning	

All three of the evaluated alternatives would meet the effluent discharge requirements. The SBR treatment system, with alum addition, was selected based on the lowest construction cost and lowest life cycle cost. The SBR technology allows for a smaller footprint, which lends itself well to the limited site area behind the existing plant. As well, the smaller footprint keeps the building costs down when all the tankage will be enclosed.

### 2.3.3 Disinfection Alternatives

Two viable disinfection methodologies for the effluent were identified: chlorination/dechlorination and ultraviolet (UV) disinfection. Both systems have ongoing operations and maintenance costs, but the UV disinfection process is preferred. The chlorination/dechlorination system would require two different chemicals plus storage tanks and associated chemical pumping systems. The UV disinfection system will incur on-going electrical costs, but the operations and maintenance of this compact system was preferred. The UV disinfection system was recommended in the Updated Feasibility Study.

## 2.4 VIRDEN WASTEWATER TREATMENT FACILITY UPGRADE PROJECT

The Functional Design Report for the Virден WWTF Upgrade Project was prepared to further develop the design of the new WWTF so that the Town is positioned to move directly into detailed design and construction of the new facility. The Functional Design also feeds the necessary information into this Environment Act Proposal document in order to obtain an Environmental License to construct the facility.

The 2013 Updated Feasibility Study included an option to phase in a new Headworks building, with temporary primary treatment and disinfection (Phase I). A subsequent phase (Phase II) would complete the facility, with secondary treatment, stabilization and dewatering of biosolids, trucked septage receiving, and UV disinfection. Subsequent to the Updated Feasibility Study, the MWSB confirmed that they are proceeding with Phase I works and Tender is planned for early 2014.

The Functional Design developed the facility concept as a whole, but also detailed how the plant will be split into two phases of work. The Phase I project scope also includes design aspects to allow it to operate independently of the existing WWTP and during construction of Phase II works. The scope of work for the Functional Design included:

- Site survey – completed during the feasibility study;
- Geotechnical investigation at the WWTF site completed by TREK Geotechnical;
- Influent wastewater sampling;
- Process mechanical functional design;
- Civil functional design and preliminary site servicing plan;
- Structural functional design;
- Building mechanical functional design;
- Electrical functional design;
- Instrumentation and controls functional design;
- Regulatory and Utility coordination;
- Facilitating a workshop to review functional design with the Town and stakeholders;
- Conducting an Open House for Town residents and stakeholders; and
- Providing input to the Environment Act Proposal (EAP) submission.

Drawings from the Functional Design report that illustrate the project components have been included in Appendix C. The following drawings are included:

- Phased Development Schematic;
- Civil Site Plan;
- Headworks/SBR/UV Room Plan at Ground Floor/Second Floor;
- Headworks/SBR/UV Room Section;
- Process and Instrumentation - Phase I Headworks;
- Process and Instrumentation - Phase 2 Secondary Treatment;
- Process and Instrumentation - Phase 2 Biosolids Treatment; and
- Hydraulic Profile.

### 2.4.1 Phasing of the Works

The MWSB and the Town of Virден have indicated that the work program will be phased as per the Discussion Paper provided in the Updated Feasibility Study. With this knowledge, the Functional Design included design aspects to be incorporated into the Phase I work (Headworks building) to minimize future costs and impact to the operations during the construction of Phase II works. In general, the scope of the Phase I work is as follows:

- Capacity assessment of existing lift station and force main;
- Construction of a new Headworks with fine screening prior to primary treatment;
- Temporary primary treatment (belt filter press by Salsnes) and disinfection (chlorination/dechlorination) will be incorporated into the new Headworks building. The belt filter press can be re-purposed into Phase II as a sludge thickener prior to aerobic digestion, thus reducing the size requirements for the digesters. A new chlorine contact basin will be incorporated into the new Headworks and could be re-purposed to a sump in the Phase II works;
- New electrical service entrance in the Headworks to supply current and future WWTF equipment and sub-feed service back to the old plant;
- Abandonment of treatment process in the original plant. If funds permit, remove existing steel tankage. Bulk chemical feed may be re-utilized for future plant requirements; and
- Relocate incoming force main to new Headworks and relocate effluent line away from future construction area for the Phase II works.

It is anticipated that the design of the Phase I works will be over the winter period, with tender in February/March of 2014. Construction could take 8 to 10 months, thus the new Headworks facility could be on line by the end of 2014. The Phase I works are shown on Plate 2-2 below.

#### 2.4.1.1 Interim Treatment Objectives

It is anticipated that after commissioning Phase I with the new primary treatment process (belt filter press), there will be a noticeable reduction in BOD<sub>5</sub> and TSS. It is difficult to predict if the equipment can achieve the supplier's claims of removal, however, at this time we can use the conservative values proposed and monitor the actual performance to determine the optimum removal rates.

Based on the supplier's proposal the following performance criteria are currently anticipated for the Salsnes Filter Press:

Average TSS influent:	220 mg/L
TSS removal:	50%
Average BOD influent:	185 mg/L
BOD removal:	25%



*Plate 2-2: Phase I and Phase II works for the Viriden WWTF Upgrade Project.*

The schedule of the Phase II works will be dependent on the availability of funding. Currently, the hope is that the Phase II work program will be a 2015 construction project. The proposed Phase II works would generally be comprised of the remaining treatment components of the WWTF. In general, they would include:

- Extension of the Headworks facility with new concrete basins and building for new equalization tank, sequencing batch reactor tanks and UV disinfection equipment.
- In the Headworks facility; the primary treatment equipment (belt filter press) will be re-purposed for biosolids thickening, the septage receiving equipment will be installed and the temporary equalization tank will be re-purposed to the septage receiving buffer tank.
- In the original facility; new tankage with aeration equipment will be installed for biosolids stabilization. Biosolids will be thickened prior to digestion and then dewatered. A new truck connection will be installed for removal and disposal of stabilized sludge cake.
- The bulk chemical systems may be re-utilized for coagulant requirements of the new WWTF. Alum is proposed ahead of the SBR process for phosphorus precipitation.

A schematic showing the phased development is provided in Plate 2-3 below. A copy is also included in Appendix C.

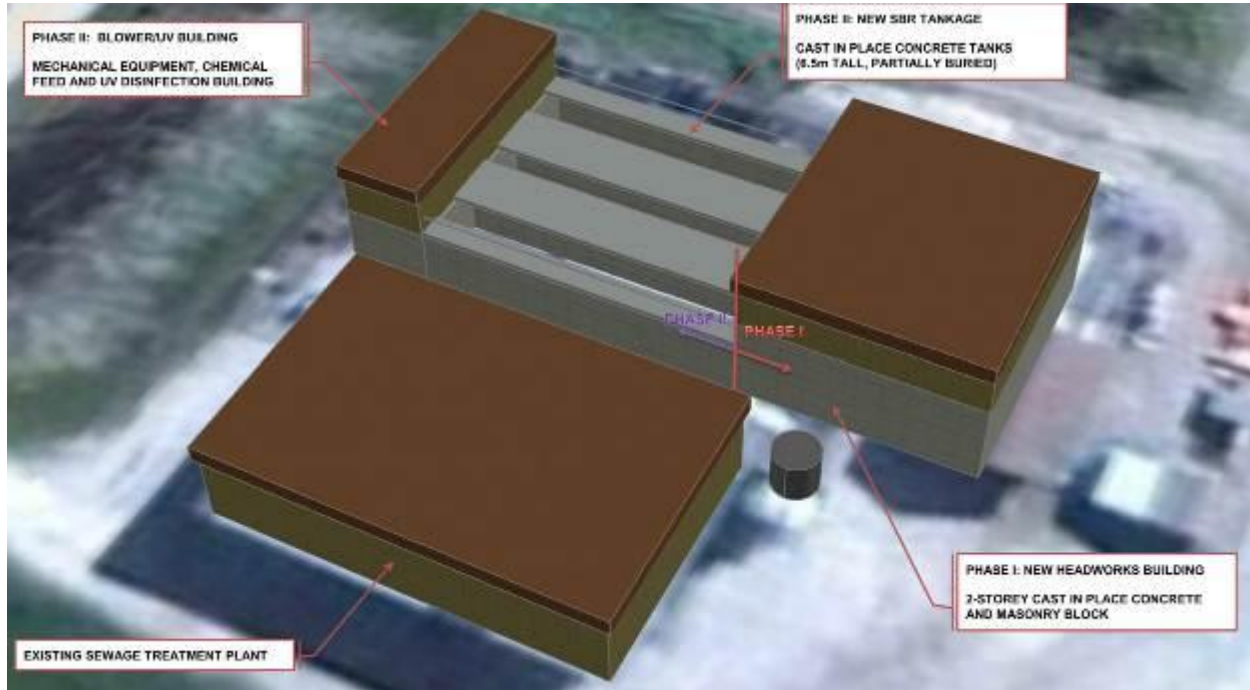

Plate 2-3: Schematic showing the location of Virден WWTF Phase I and Phase II project components.

## 2.4.2 Design Criteria

### 2.4.2.1 Design Year and Population

A 20-year design period was used for calculating the WWTF size. The Town's design population was projected at 60 residents per year from 2013 to 2033 for a design population for the Town of 4,700 residents. The Town also projects that in the future an additional 300 people from the R.M. of Wallace may be connected to the sanitary system. This brings the piped serviced design population to 5,000 residents.

Additionally, the Town would like to provide a septage receiving station sized to accommodate up to six (6) 9,500 L (2,500 US Gal) septic trucks per day from those residents on low pressure sewer as well as those in the R.M. of Wallace. This equates to receiving 57 m<sup>3</sup>/day from truck haul. The sludge acceptance equipment is generally planned for installation during the Phase II works.

### 2.4.2.2 Effluent Criteria

As noted in Section 1.2.2 in Tables 1-2 and 1-3, treated effluent criteria have been developed through discussions with Manitoba Conservation. Based on Table 1-3, nitrification or partial nitrification is only required if the pH of the final effluent falls below 7.5.

### 2.4.2.3 Design Flows

The design flows were derived from water meter data and peaking factor calculations. The historic data was considered suspect and there were no records of calibration of the flow meter in the Parshall flume. The Functional Design report recommended that the Town implement a flow monitoring program to validate the calculated numbers.

The Town residents are generally connected to a piped sanitary sewer collection system. For the most part they are on a gravity system, with some smaller areas on low pressure sewer tied into the gravity system. There are some rural residents on the outskirts of Town that are also connected to the piped system. It is projected that the number of connected R.M. of Wallace residents will be upwards of 300 homes by 2033. In addition to these connected homes, the R.M. of Wallace reports that there are approximately 500 rural homes primarily on septic tanks and fields. Historically this waste was trucked to the existing plant until the recent process failure. Although the R.M. of Wallace is currently reviewing their options for septage disposal, it is assumed at this time that they will be resuming their use of the new WWTF once it is operational.

During the design period, up to 2033, the Town is projecting an average population growth of 60 new residents per year (~ 13% per year). In addition to this, the town anticipates that on average 15 R.M. of Wallace residents per year will also connect to the piped sewer system. Assuming the current connected population is around 3,500 people; in 2033 the project connected population will grow to be approximately 5,000 people. Based on these population figures, the resulting design flows are shown in Table 2-2.

**Table 2-2  
 Design Wastewater Flows**

Year	Population	Average Annual Flow (AAF) (m <sup>3</sup> /d)	Average Dry Weather Flow (ADWF) (m <sup>3</sup> /d)	Maximum Daily Flow (MDF) (m <sup>3</sup> /d)	Maximum Hourly Flow (MHF) (m <sup>3</sup> /d)	Maximum Monthly Flow (MMF) (m <sup>3</sup> /d)
2011	3,200	1,120	1,008	2,016	3,024	1,512
2013	3,500	320	1,120	1,008	2,016	3,024
2018	3,875	315	1,221	1,099	2,197	3,296
2023	4,250	310	1,318	1,186	2,372	3,557
2028	4,625	305	1,411	1,270	2,539	3,809
2033	5,000	300	1,500	1,350	2,700	4,050



The design flows were determined for Average Dry Weather Flow (ADWF), Maximum Daily Flow (MDF), Maximum Hourly Flow (MHF) and Maximum Monthly Flow (MMF). The MMF, MDF and MHF were determined using peaking factors that related maximum flows to average daily flows.

The peaking factors were defined as follows:

- Peak Month Factor (PMF) = 1.5;
- Peak Day Factor (PDF) = 2.0; and
- Peak Hour Factor (PHF) = 3.0.

#### **2.4.2.4 Design Contaminant Loadings**

A raw wastewater sampling program was recommended in the Updated Feasibility Study as there had been limited raw water characterization data to date. The sampling program indicated that the wastewater Viriden produces can be categorized as low strength (Metcalf and Eddy 2004).

Table 2-3 shows a comparison of projected 2033 loadings and concentrations, with data obtained in the two-week sampling program. The lower g/cap/d value from the typical range (Metcalf and Eddy, 2004) was used for comparison. The projected loading calculations are based on the 2033 design population of 5,000 people and an ADWF of 1,215 m<sup>3</sup>/d. The per capita values were then back calculated based on the two-week sampling data to provide a comparison of typical to actual data. It is shown that the calculated percent difference between the typical and actual per capita values is relatively large (> 20%) for most parameters. Therefore, the use of typical per capita generation rates was employed for design purposes.

The numbers that were used in the design are highlighted in Table 2-3 below.

**Table 2-3  
 Comparison of Projected and Actual Contaminant Loadings**

Parameter	Projected Loading (2033)			Actual Loading			% Difference
	Metcalf & Eddy (2004)			Two-week Survey, July 2013			
	g/cap-day	kg/day	mg/L	g/cap-day	kg/day	mg/L	
BOD <sub>5</sub>	50	225	185	41	182	150	19%
COD	110	495	407	81	365	300	26%
TSS	60	270	222	21	94	77	65%
NH <sub>3</sub> -N	5	23	19	5.4	24	20	7%
Organic N	4	18	15	1.4	6	5	66%
TKN	9	41	33	6.8	30	25	25%
Total P	2.7	12	10	0.9	4	3.5	65%
Oil and grease	10	45	37	6.9	31	25.4	31%

<sup>(1)</sup> Estimates based on the lower value of typical range from Metcalf & Eddy 4<sup>th</sup> Edition, Table 3-12.

<sup>(2)</sup> Average day concentrations calculated using 2033 population of 4,500 and ADWF of 1,215 m<sup>3</sup>/d.

#### 2.4.2.5 Wastewater Design Temperature

A design temperature of 10° C has been assumed for the wastewater. The Functional Design report recommended monitoring temperatures over one year to confirm this estimate.

#### 2.4.3 Plant Site Components

The new WWTF will be situated on the existing WWTP site. The new WWTF will be constructed south of the existing plant. The general location is shown in Plate 2-4. The available room on the site is limited, however, the plant footprint will fit suitably within the site constraints, and the advantage of being on the existing site is the proximity of the influent lines and existing outfall, as well as remaining in an industrial area away from residential development. Additionally, the components and structure of the existing plant can be re-used within the new treatment process.

The general site layout shows the new plant Headworks, Sequencing Batch Reactor and UV Disinfection located south of the existing plant. The existing plant will house the Aerobic Digesters and Biosolids Dewatering, and control room.



Plate 2-4: New Virден WWTF and existing WWTP location.

The Functional Design included the following components related to the treatment system:

Phase I works:

- Headworks with fine screens, grit removal and flow measurement;
- Equalization tank (future septage receiving tank);
- Primary treatment (Belt Filter Press, Salsnes Filter or ECO Mat);
- Interim disinfection (chlorination / dechlorination) with contact basin;
- New electrical service entrance; and
- Stand-by power to the Headworks.

Phase II works:

- Construct new building extension to house new Sequencing Batch Reactors, Blowers Control building and UV Disinfection equipment. The need for effluent equalization will be further evaluated during Detailed Design;
- Install chemical feed additions (Sodium Hydroxide and Alum);
- Install new Sludge Digestion/Dewatering equipment in original facility;
- Install additional standby power for entire facility;
- Construct septage receiving tank, install new transfer pumps and septage receiving equipment; and
- Re-purpose belt filter press (interim primary treatment) for biosolids thickening prior to digestion.

#### **2.4.4 Process Mechanical**

Process mechanical components for the functional design include equipment required for treating the liquid and solid streams. The Updated Feasibility Study identified Sequencing Batch Reactor (SBR) Treatment as the primary liquid stream treatment process. For solids treatment aerobic digestion and mechanical dewatering were selected. Process flow diagrams are included in Appendix C, as well as a hydraulic profile of the proposed WWTF.

##### **2.4.4.1 Pumping Station Upgrade**

Raw wastewater from the Town of Virден's sewage collection system drains to a lift station located on 6<sup>th</sup> Avenue South. The station then pumps the sewage to the existing WWTP. The lift station has two pumps, each capable of pumping 60 L/s at 15 m.

The current pumping station appears to have sufficient pumping capacity to accommodate the projected population for the next 15 years. As the pumps are replaced due to age, the sizing can be reviewed at that time. With the Town also considering installing a second main lift station to split the collection system into two parts, the pump sizes will also be further reviewed.

With only the addition of the Phase I works at this time, the lift station will continue to pump to ground level to fill the below-grade interim equalization tank. From there it will be pumped up to the screens. However, after the Phase II works, the lift station pumps will need to pump directly to the raised screens.

##### **2.4.4.2 Force Main Upgrades**

Town records indicate that the existing force main consists of ~350 m of 200 mm diameter fused HDPE. The force main runs fairly straight from the main lift station to the existing WWTP. Velocity through this force main is approximately 2.0 m/s at 60 L/s, resulting in a friction headloss of approximately 6.0 m. At the future 2033 population, if the Town were to remain on this single main lift station, the pumps would likely be upgraded to 75 L/s at 20 m. Velocities would then increase to 2.5 m/s in the current force main size.

The existing force main appears to have sufficient capacity to accommodate the projected population for the next 15-20 years. Its condition, however, should be inspected in the next 10 years.

To accommodate the new WWTF, the force main will be extended from where it ties into the existing plant to the new Headworks equipment. The extension and routing would be about 20 m and the new force main material would likely be HDPE.

##### **2.4.4.3 Septage Receiving Station**

At this time, the final design will incorporate a new septage receiving station to accommodate the residents on low pressure sewer as well as those R.M. of Wallace residents on septic tanks. During the interim, the Phase I design package will install the septage holding tank and use it as an equalization tank prior to the interim primary treatment process.

The Town will need to confirm the addition of the septage receiving station prior to Detailed Design. The R.M. of Wallace is currently in the process of completing a Feasibility Study to determine if they will haul to the Town's new WWTF or construct their own lagoon to accept the haulers. If the R.M. of Wallace decides to proceed with the lagoon option, the Town may decide to postpone the installation of a septage receiving station in the scope of works.

The septage receiving station will be sized to accommodate up to 57,000 L per day of septage from septic tanks (high strength liquid with high solids). It will consist of a controlled access system, piped (e.g. camlock) connection (with optional hydrocarbon detection). The septage will be passed through a coarse self-cleaning screen to remove large debris and then dumped into a septage holding tank. Two submersible pumps will then be placed within the septage tank and they will pump out the tank through a flow meter into the main raw wastewater line, located after the inlet chamber and prior to the screening channels in the Headworks.

#### **2.4.4.4 Headworks**

Raw wastewater will enter from the main lift station(s) force main(s) to the Headworks station of the WWTF at a residual hydraulic head of 20 m. The Headworks will consist of an inlet chamber, splitting into two channels: one channel with fine mechanical screens; and another with manual bar screens (for temporary bypass). These channels combine and flow into the grit removal equipment. A new building will house the accompanying Headworks equipment.

In general, the entirety of the Headworks equipment will be installed as Phase I work, with the exception of most of the septage receiving equipment. During the interim operation, after the Phase I works are completed, the incoming raw wastewater will flow into the building through a magnetic flow meter and discharge directly into the inlet chamber then flow to the screen channels and grit removal vortex. Following grit removal, the wastewater will be directed to the equalization tank (future) and the belt filter press, and then flow by gravity through the temporary chlorine contact chamber.

The Headworks building will house the interim primary treatment equipment (belt filter press, Salnes Filter type), interim disinfection equipment (chlorination/dechlorination) and contact basin. It will also house the new electrical service entrance for the current and future equipment, and sub feed service back to the original plant. The belt filter press equipment requires a hot water supply for washdown, thus a mechanical room will also be included with water heaters.

##### **2.4.4.4.1 Inlet Chamber**

The inlet chamber will be a concrete channel that accepts flow from the Town's collection system. A magnetic flow meter on the force main upstream of the inlet chamber will measure the flow entering the plant.

##### **2.4.4.4.2 Screens**

The main channel will be split into two (2) channels. One channel will have a mechanical screen, the other will have a manual bar screen for by-pass. The second channel will have provisions for a

mechanical screen in the future. The mechanical fine screen will be sized to process the peak lift station flow rate.

The screen design is based on a shaftless stainless steel spiral fine screen (6 mm), which has been proven to be reliable and robust in a number of installations of similar size to the new Virден WWTF. The screen is supplied with pivoting capability for service. The unit consists of a solids capture screen, a shaftless cleaning/conveying spiral and a drive motor.

The design criteria for the perforated mechanical screening system are shown in Table 2-4 below.

**Table 2-4**  
**Design Criteria for Automatic Screens**

<b>Parameter</b>	<b>Design Criteria</b>
Design flow rate per screen (Lift Station capacity)	75 L/s
Number of screens	1
Applied perforation size	6 mm
Headloss, 50% blinding	TBA
Approach velocity	< 0.6 m/sec
Channel width	400 mm
Channel depth	1250 mm
Downstream water depth at peak flow	TBA

The design specifications for the mechanical screening system are shown in Table 2-5 below.

**Table 2-5  
 Design Specifications for Automatic Screens**

Item		Specification
Screens	No. of units	1
	Peak flow rate per unit	75 L/s
	Screen opening size	6 mm mesh
	Headloss at peak flow (clean water)	TBA
Screenings Washing Compactors	No. of units	1
	Solids volume reduction	40 - 50%
	Organics reduction	50 - 60%
	Dryness	20 - 30%
	Processing Capacity	0.5 m <sup>3</sup> /hr
Screenings Bins	No. of units	1
	Volume, each	TBA
Bagging Unit	No. of units	1

The solids progressively collect onto the screen mesh and cause it to gradually bind. The spiral is activated as the upstream water level rises. Replaceable cleaning brushes are attached to the periphery of the spiral, in the screen area, to clean the openings. The spiral screw then conveys the solids up to the compaction and dewatering zone, for screenings dewatering and volume reduction. Compacted screenings are continuously collected into a bag to contain odours. The water that is squeezed out of the screenings returns to the channel upstream of the screen.

The screens will be automatically cleaned as the solids are lifted to the transport zone. The cleaning brushes located on the spiral screw flight edge sweep the screen surface while bristles puncture through the openings to keep them clean. Washing the dewatering screen of the compacting zone is accomplished by opening the compacting zone solenoid valve once a day for a predetermined short set time. Wash water will be final effluent water from downstream of the UV treatment units. In the interim phase, the wash water will be provided from the Town's potable water supply.

#### 2.4.4.4.3 Grit Removal

Grit will be removed through a vortex multiple tray system, located immediately downstream of the screening facility. This process is designed for the lift station flow of 75 L/s. With two fine screens upstream, the Functional Design recommended a single grit removal unit.

The grit removal system has been based on the following design criteria:

**Table 2-6  
 Design Criteria for Grit Removal System**

Parameter	Value
<b>Hydraulic design</b>	
Average dry weather flow (m <sup>3</sup> /d)	1,215
Peak wet weather design flow (m <sup>3</sup> /d)	5,625
Lift Station Flow Rate	75 L/s
<b>Solid Handling Design</b>	
Performance (at peak flow, specific gravity 2.65)	95% removal of all grit ≥ 106 microns
Peak grit concentration (% solids)	60
Channel depth (m)	TBA
Downstream water depth at peak flow (m)	TBA

The design specifications for the grit removal system are shown in Table 2-7 below.

**Table 2-7  
 Design Specifications for Grit Removal System**

Item	Specification	
General/Overall	Type of grit chambers	Vortex-stacked tray
	Capacity	5,625 m <sup>3</sup> /d
Grit Chamber	Diameter	1.8 m
	Depth	3.34 m
	Headloss	305 mm
	Grit pump capacity	12.6 L/s
Grit Washer/Classifier	Type	Vortex
	Diameter	0.6 m
	Capacity	12.6 L/s with 0.6 m headloss
Grit Dewatering	No. of units	1
	Screw diameter	0.3 m
	Clarifier size	0.7 m
	Capacity	0.57 m <sup>3</sup> /hr



The screened wastewater discharges to a common channel leading to the grit removal system. The unit is equipped with a stack of hydraulically independent polyethylene trays submerged in a concrete chamber and is capable of removing 95% of all grit (specific gravity 2.65, based on EPA Standards) greater than 106 microns at peak flow. It uses vortex flow and stacked tray design to capture and settle fine grit via large surface areas and short settling distances.

Screened sewage enters the influent duct and passes into the grit chamber. The flow is directed into a distribution header to evenly distribute the influent tangentially into the modular multiple-tray system. Tangential feed establishes a vortex flow pattern causing solids to fall into a boundary layer on each tray. Grit settles out by gravity along the sloped surface of each tray and then solids are swept to the center opening, which allows them to fall to a common collection sump. De-gritted effluent flows out of the trays, over a weir and into an effluent trough. The settled solids are continuously pumped from the grit sump to a grit washing system and then dewatered. The grit is finally collected into a bin. A gate is provided to bypass the grit removal system under emergency conditions.

Grit collected in the storage hopper is periodically fluidized, with high-pressure plant water to free accumulated organics and assist in grit extraction from the hopper. The fluidized grit is pumped using a dry-pit grit slurry pump to the grit washer/classifier. Grit settles out from the slurry in the grit classifier and is dewatered and transferred by a rotating screw to the disposal bin.

The grit fluidizing, associated pumping system and downstream grit dewatering screw are adjustable through the SCADA, which will control the sequence of operations of individual components. The grit removal cycles will be controlled by an adjustable 24-hour timer.

#### **2.4.4.5 Sequencing Batch Reactors**

Following screening, and grit removal, the wastewater will be directed to the Sequencing Batch Reactors (SBR). SBRs were selected as the liquid stream process in the feasibility stage of the work. The SBRs will receive wastewater from a splitter channel. Advantages of SBR include elimination of secondary clarifiers and return activated sludge (RAS) pumping systems, as well as high tolerance for short-duration peak flows and loadings, and operational flexibility. In addition, SBRs provide an economical footprint, which creates a distinct advantage for the proposed site and allows for ease of expansion. The design is based on Parkson's *EcoCycle SBR™* treatment system.

It is highly recommended in the functional design report that the SBR equipment and supplier be pre-selected prior to Detailed Design of the Phase II works. With the high variability of equipment, depending upon the supplier, the design needs to tailor the specific equipment. For example, local suppliers range from conventional SBR processes to continuous flow SBRs.

Assuming the more conventional SBR process, the following design criteria have been used in the sizing of the SBRs:

**Table 2-8  
 Design Criteria for Sequencing Batch Reactors**

<b>Parameter</b>	<b>Value</b>
Average dry weather flow	1,215 m <sup>3</sup> /d
Maximum daily flow (24 hour Period)	2,430 m <sup>3</sup> /d
Peak wet weather flow (24 hour Period)	5,625 m <sup>3</sup> /d
Centrate flow	TBD
Aerobic digester supernatant	41 m <sup>3</sup> /d
BOD <sub>5</sub> load	450 kg/d
TSS load	535 kg/d
Alkalinity	300 mg/L
Maximum wastewater temperature	18° C
Minimum wastewater temperature	10° C
F/M	0.15 to 0.4 kg BOD <sub>5</sub> /kg MLSS
Aerobic solids retention time	10 days
MLSS	3,500 mg/L
SVI	150 mL/g
Minimum freeboard	> 600 mm
Low water depth	> 3 m

In addition, the decantable volume and decanter capacity of the SBR, with the largest basin out of service, will be sized to pass at least 75% of the peak daily flow without changing cycle times. A decantable volume, providing at least four (4) hours retention time with the largest basin out of service based on 100% percent of the peak daily flow, has been recommended.

Based on the above criteria, the design specifications for the SBR are as follows:

**Table 2-9  
 Design Specifications for Sequencing Batch Reactors**

Item	Value
Number of basins	3
Basin width	~6.0 m
Basin length	~23.5 m
High water level	6.1 m
Bottom water level	4.6 m
Total volume	2,470 m <sup>3</sup>
Decant volume per basin	TBD
Average flow per decanter	TBD
Decant time	30 - 40 min
Waste activated sludge produced	432 kg/d
Waste activated sludge volume	51 m <sup>3</sup> /d
Jet aeration maximum gassing rate	2.27 m <sup>3</sup> /min/jet
Number of jets per basin	10
Number of jet pumps	3
Total jet pump power per basin	9.4 BkW
Blower size, each (2 duty, 1 standby)	10.4 BkW

Alum will be dosed for phosphorus removal at the entrance of each SBR basin.

The SBRs will process four (4) batches per day. A complete cycle time will take six (6) hours per basin. The cycle times for a typical conventional SBR would be:

- Normal Flow - 90 minutes anoxic fill; 90 minutes aerated fill; 90 minutes react; 45 minutes settle; 35 minutes decant; and 10 minutes idle;
- Storm Mode - 90 minutes aeration; 45 minutes settle and 45 minutes decant, for a total of three (3) hours; and
- Emergency maintenance - 60 minutes aeration; 30 minutes settle; and 30 minutes decant, for a total of two (2) hours.

The typical phases in an SBR process are:

- Anoxic fill;
- React;
- Settle;
- Decant; and
- Idle/waste sludge.

Aeration air will be supplied by jet aeration. The pumping system (jet motive pumps) re-circulates mixed liquor in the SBR basin, ejecting it with compressed air through a nozzle assembly. The jets combine the functionality of diffused aeration and mechanical aeration, since both pumps and blowers are used. The system consists of two (2) aeration manifolds, two (2) jet motive pumps and eight (8) jet aerators for each manifold. Positive displacement (PD) blowers are used to introduce air downstream of the jet motive pump discharge.

Incoming wastewater has sufficient alkalinity (about 300 mg/L) to ensure adequate buffering for nitrification that might occur during the summer months. The nitrification process consumes 7.14 mg/L of alkalinity for each mg/L of ammonia nitrogen oxidized. An alkalinity of no less than 150 mg/L would be required at the Virден WWTF. If it is later observed that the incoming wastewater has alkalinity values less than 150 mg/L, then there will be a need to dose sodium hydroxide at the influent channel to the SBR on a seasonal basis.

Waste sludge will be removed from each SBR basin during the idle phase of the cycle, with a submersible pump, and discharged directly to the aerobic digester. The WAS pumps will be operated on timers or operator selected.

The following design criteria apply for the WAS pumps:

**Table 2-10**  
**Design Criteria for Waste Activated Sludge Pumps**

Parameter	Value
Number of pumps	2
Type	Submersible, recessed impeller <sup>(1)</sup>
Capacity	100 L/min
Head	5 m
Operation	Intermittent

#### **2.4.4.6 Effluent Disinfection**

##### **2.4.4.6.1 Chlorination/Dechlorination**

In Phase I, the effluent from the belt filter press (Salsnes Filter or ECO Mat) will be disinfected with a hypochlorite solution. A chlorine dose of 20 mg/L is typically required for primary effluent disinfection. The dose will be adjusted according to the quality of the primary effluent. For de-chlorination the theoretical dose required to neutralize 1 mg Cl<sub>2</sub>/L is 1.46 mg/L of sodium bisulfite.

The basic components of the system include a double wall bulk tank (~10,000 L) for the hypochlorite solution, metering pumps (duty/stand-by) that consists of a positive displacement pumping mechanism, motor or solenoid, feed-rate adjustment device and an injection device. The sodium bisulfite solution (for de-chlorination) will be stored and fed the same way as the hypochlorite.

The hypochlorite solution should be mechanically mixed with the primary effluent as rapidly as possible. This is achieved by either the use of turbulent flow or a mechanical flash mixer. The chlorination system shall have a minimum contact time of 30 minutes at design average daily flow and not less than 15 minutes at design peak hourly flow or maximum rate of pumping. Contact time will be provided with two pass channels, with length to width ratio of 40:1 (for full plug flow).

The sodium bisulfite is injected at the end of the contact tank. A minimum of 30 seconds for mixing and contact time needs to be provided at peak design flow or maximum rate of pumping.

Control of hypochlorite and sodium bisulfite feed rates can be manual, semi-automatic or automatic with flow proportional control.

Facilities need to be included for sampling the de-chlorinated effluent for measurement of indicator bacteria and residual chlorine. Manual or automatic control of sodium bisulfite rates may be based on flow, chlorine residual, oxygen reduction potential (ORP) or sulfite or sulfate residuals measurements.

#### 2.4.4.6.2 UV Disinfection

To achieve the design guideline level for effluent disinfection (<200 MPN/100 mL of fecal coliform or *E.coli* based on 30-day geometric mean), an ultraviolet (UV) system will be utilized prior to discharge into the outfall in Phase II. The system has been sized according to the following design criteria:

**Table 2-11**  
**Design Criteria for UV Disinfection System**

Parameter	Value
Maximum daily flow	2,430 m <sup>3</sup> /d
Peak hourly flow	3,645 m <sup>3</sup> /d
Peak disinfection limit (maximum) <sup>(1)</sup>	200 MPN/100 mL
UV transmittance (minimum)	65%
TSS	25 mg/L
Reduction equivalent dose (RED)	> 80 mJ/cm <sup>2</sup> <sup>(2)</sup>
End of lamp life factor	0.87
Fouling factor	0.95

<sup>(1)</sup> System must provide 75% capacity with the largest unit or module out of service.

<sup>(2)</sup> Surrogate microorganism MS-2 or T1/T7.

Based on the criteria listed above, the following design has been recommended for the UV disinfection system:

**Table 2-12**  
**Design Specifications for UV Disinfection System**

Item	Value
Number of banks	1 duty, 1 standby
Number of modules per bank	3
Number of lamps per module	10
Lamp type	Low pressure, high intensity
Lamp cleaning system	Mechanical and/or chemical
UV-C output	Variable
Protection Class	IP 54
Channel length	5.5 m
Channel width	0.3 m
Channel depth	1.0 m

Two UV reactors in series will receive the treated water from the equalization tank after the SBR. The UV units will be situated in a concrete channel (or fabricated channel). The units will be situated in series and each will be rated for 75% of the maximum hourly flow. The stand-by generator will provide back-up power to the units in the case of a power outage. Each of the UV system modules is individually powered, thus providing intrinsic redundancy. A spare ballast (shelf-spares) and four (4) additional lamps will be provided to ensure that those items that are at risk of failure can be replaced within 24 hours.

The performance of the UV system is typically affected by the flow rate, water quality (UVT), coating of the quartz sleeves, lamp age and ballast power. Operation of the system is such that the system's output is adjusted automatically to match flow and water quality in real time. This avoids over dosage and reduces overall operating costs without compromising performance.

#### 2.4.4.6.3 Effluent Reuse

Treated effluent will be reused for processes and wash down of equipment. The effluent reuse system can also be connected to an on-site irrigation system. The design criteria for the effluent reuse pumping system are as follows:

**Table 2-13  
 Design Criteria for Effluent Reuse Pumps**

Parameter	Value
Number of pumps	2 (1 duty, 1 standby)
Effluent reuse pumping firm capacity	15 L/s
Head	70 m <sup>(1)</sup>

<sup>(1)</sup> Capacity will be determined when other equipment has been defined.

The specification for the effluent reuse pump is as follows:

**Table 2-14  
 Design Specifications for Effluent Reuse Pumps**

Parameter	Value
Pump capacity	15 L/s at 70 m TDH
Pump motor	16 kW, 3 phase, 60 Hz, 600V, VFD
System pressure setting	517/75 kPa/psi

The effluent reuse pumps will be installed adjacent to the UV Disinfection channel. No provisions are currently made for a hypochlorite/bisulfite system to provide standby chlorine disinfection.

Each effluent reuse pump will have a VFD to avoid excessive pump starts and stops, and a pressure transmitter installed on the pump discharge header will control the speed of the duty pump to maintain a

system pressure of 517 kPa (75 psi). A pressure tank will be connected with the pump discharge header to supply water while flow demand is smaller than the pump capacity at minimum speed. The duty pump will start when the system pressure reaches 310 kPa (45 psi).

#### 2.4.4.6.4 Effluent Discharge

The liquid stream effluent discharge will exit the UV Disinfection train and flow through the existing Parshall flume and out to a surface discharge channel that empties into Gopher Creek via the existing outfall structure.

A Parshall flume for flow measuring will be constructed immediately downstream of the UV equipment. This facility is designed for the ultimate peak wet weather flow of 5,625 m<sup>3</sup>/d.

One (1) Parshall flume, complete with flow indicating transmitters will be installed according to the following design criteria:

**Table 2-15**  
**Design Criteria for Parshall Flume**

Parameter	Value
Number of units	1
Average dry weather flow	1,215 m <sup>3</sup> /d
Peak wet weather flow	5,625 m <sup>3</sup> /d
Flume throat width	TBD

#### 2.4.4.6.5 Composite Sampling

An automated composite sampler with refrigerated storage will be permanently installed on the effluent side of the plant.

#### 2.4.4.6.6 Outfall Pipe

The existing outfall pipe at 300 mm is sufficiently sized to handle the current and future flows. A condition assessment of the structure will be undertaken during detailed design to verify the physical condition of the pipe.

#### 2.4.4.6.7 Outfall Structure

The existing outfall structure will remain in use with no modifications required.



## 2.4.4.7 Biosolids Treatment

### 2.4.4.7.1 Aerobic Digester

Aerobic digesters are designed to stabilize the Waste Activated Sludge (WAS) from the SBRs to produce Class B biosolids, and to reduce the volume and weight of recovered biosolids, and control odours. Some of the advantages of aerobic digestion as compared to anaerobic digestion include:

- Similar volatile solids destruction to anaerobic digestion;
- Lower BOD concentrations in the supernatant that is returned to the plant Headworks for additional treatment;
- Production of relatively odorless, stabilized biosolids;
- Relatively easy operation; similar to conventional activated sludge; and
- Relatively lower capital costs.

The major disadvantages of the aerobic digestion process are related to the higher power cost associated with the aeration system, poor biosolids dewatering characteristics and impact of a variety of factors such as temperature, tank geometry, mixing device, and concentration of feed solids.

The retention time in the digesters must be at least 45 days, including both digester stages and the SRT of the waste activated sludge process. The design criteria for the WAS aerobic digester system are as follows:

**Table 2-16**  
**Design Criteria for Aerobic Digester**

Parameter	Value
Number of stages	2 <sup>(1)</sup>
Waste activated sludge	432 dry kg/d
Total solids concentration	2%
Waste activated sludge flow	51 m <sup>3</sup> /d
Solids retention time	45 days <sup>(2)</sup>
Winter temperature	10° C
Summer temperature	18° C
Volatile solids reduction after digestion	45%
Reaction rate constant	0.06 k <sub>d</sub> (d <sup>-1</sup> )

<sup>(1)</sup> Two-thirds of the total digester volume should correspond to Stage 1 and one-third to Stage 2.

<sup>(2)</sup> Includes SRT of the waste activated sludge process.

The aerobic digestion process involves two main mechanisms:

- the supply of oxygen as air for biological metabolism; and
- mixing to eliminate stratification, and thus eliminate septic conditions.

A Tideflex "Check Valve" Coarse Bubble Diffuser system combined with Positive Displacement (PD) blowers will be used in order to achieve enhanced aeration and mixing. The design was developed taking into consideration a variety of factors for the selection of the associated mechanical equipment, including low life cycle costs, operational flexibility and low maintenance.

One (1) aerobic digester will be installed as part of the new Biosolids and Control building.

Supernatant will be decanted to a hopper and then it will be pumped back to the inlet channel upstream of the SBRs. Thickened sludge will be transferred by gravity to a biosolids day tank and will then be pumped to the dewatering unit. The day tank is sized to provide a three (3) day storage capacity at ultimate average biosolids production so that operation of the belt filter press has maximum flexibility. The day tank will be mixed with submersible mixers.

The specification of the aerobic digestion system is provided below. Since the sludge dewatering system is operated five (5) days per week and eight (8) hours per day, additional storage volume has been provided in the digesters.

**Table 2-17**  
**Design Specifications for Aerobic Digester**

Parameter	Value
Number of digesters	1, with 2 stages
Digester dimensions (length x width x height)	11 x 6 x 6 m 8 x 6 x 6 m Stage 1 3 x 6 x 6 m Stage 2
Aeration and mixing system	Tideflex "Check Valve" Coarse Bubble Diffuser
Number of PD blowers	1
Blower capacity, each	TBD
Blower differential pressure	TBD
Total decanting rate	TBD
Decanter motor	0.25 HP
Decanter motor power supply	1 phase / 60 Hz / 120V
Supernatant pumps	1 duty, 72 L/s at 6 m TDH
Supernatant pump motor	20 HP

Parameter	Value
Supernatant pump motor power supply	3 phase / 60 Hz / 575V
Sludge transfer pump	2 duty, 6.4 L/s at 6.5 m TDH
Sludge transfer pump motor (each)	3 HP
Sludge transfer pump power supply	3 phase / 60 Hz / 575V VFD

Depending on the buffering capacity of the system, the pH may drop to low levels between 5.0 and 6.0 at long hydraulic retention times. A sodium hydroxide feed system is to be included in the process to adjust pH when it is found to be excessively low.

#### 2.4.4.7.2 Biosolids Dewatering

A screw press will be installed to allow dewatering of digested biosolids before haulage off-site. The dewatering facility is designed to provide adequate process flexibility, space and interconnections for future build-out capacity of 1,215 m<sup>3</sup>/d ADWF for the design period.

Digested biosolids will be periodically pumped through a dedicated submersible pump to a screw press located in the press room of the Biosolids and Control building for dewatering. Cake from the press is discharged to a horizontal reversing conveyor that directs cake to one dedicated storage bin. Dewatered solids shall achieve a dry solids concentration of between 18 and 24%.

The design criteria of the dewatering system are as follows:

**Table 2-18**  
**Design Criteria for Screw Press**

Parameter	Value
<b>Digested Biosolids</b>	
Solids loading	100 kg/hr
Flow	5 - 10 m <sup>3</sup> /hr
Solids concentration	2%
<b>Dewatered Cake</b>	
Solids loading	TBD
Flow	TBD
Solids concentration	20%

The specifications for the dewatering system are as follows:

**Table 2-19  
 Design Specifications for Screw Press**

Parameter	Value
<b>Centrifugal Screw Feed Pumps</b>	
Number of units	2 pumps (1 duty, 1 standby)
Type	Submersible, centrifugal screw
Capacity at rated pressure, each	5.3 L/s at 7 m TDH
Motor size	3 HP
Motor power supply	3 phase / 60 Hz / 575V VFD
<b>Screw Press</b>	
Number of units	1
Shaft diameter	TBD
Maximum main drive motor speed	1.5 rpm
Maximum polymer dose	10 - 12 kg/dry ton of biosolids
Minimum cake concentration	20% solids
Minimum solids capture efficiency	95%
Motor size	0.5 HP
Motor power supply	3 phase / 60 Hz / 575V
<b>Cake Storage Bins</b>	
Number of units	1
Capacity	TBD
Dimensions	TBD
<b>Dewatered Cake Conveyor</b>	
Number of units	1
Type	Horizontal, shafted, reversing
Length	TBD
Motor size for screws	TBD
Width for screws	TBD

Digested biosolids will be received in one (1) constantly mixed day tank at the new Biosolids and Control building. Two (2) submersible sludge feed pumps (1 duty and 1 standby), located in the bottom of the day tank, will pump sludge to the screw press located on the top floor of the Biosolids and Control building. Polymer will be added in-line at one (1) of two (2) injection points prior to the press.

The dewatering equipment will discharge dewatered solids directly into one (1) dedicated storage bin located in the ground floor of the Biosolids and Control building. A horizontal conveyor will transport the cake from the press to the storage bins; however, depending on the actual arrangement, a conveyor might not be needed.

There might be a need to install a diverter gate on the press discharge to ensure un-watering during press operation and maintenance, and to prevent flushing water leakage into the storage bin, but this will be confirmed with the equipment manufacturer during detailed design.

The polymer feed system, located on the ground floor of the Biosolids and Control building will provide multiple in-line polymer addition points, using emulsion polymer. The emulsion polymer system will have an installed capacity to meet peak month conditions. The process control goals for the dewatering process are based on maintaining a consistent feed to the press, and achieving dewatered solids concentrations of about 20% TS, solids capture efficiency >95%, with minimal polymer usage (10-12 kg/t). The actual type of polymer and dosing requirements will be defined later with information from the press manufacturer.

#### **2.4.4.7.3 Biosolids Disposal**

During Phase I and Phase II operation, biosolids will be transported to the Town of Virден landfill facility and placed in the sludge dewatering cell. As noted in the Canadian Council of Ministers of the Environment (CCME) *Canada-Wide Approach for the Management of Wastewater Biosolids* (October 2012), municipal biosolids contain valuable nutrients and organic matter that can be recycled or recovered as energy. The policy statement from CCME promotes the beneficial reuse of municipal biosolids through composting, agricultural land application and combustion for energy, among other options. Beneficial reuse also minimizes the net greenhouse gas emissions associated with wastewater treatment by reducing fertilizer use and enhancing the land storage of carbon.

A beneficial reuse study has not been completed for the biosolids from the Virден WWTF Upgrade project as part of the Functional Design Study. A feasibility study to assess the beneficial reuse of biosolids should be undertaken to determine whether the Virден WWTF Upgrade biosolids meet the standards in Manitoba, which indicate the biosolids must be stabilized by anaerobic digestion for a period of thirty (30) days at a minimum temperature of 20 °C, or an equivalent process. Currently, there is no distinction between Class A and Class B biosolids in Manitoba. Land application of biosolids and sludge in Manitoba is regulated under the Environment Act, and therefore, before any reuse is undertaken, an application under the Act must be made. This current EAP does not include a proposal for the beneficial reuse of biosolids from the Virден WWTF Upgrade.

#### **2.4.4.8 Chemical Dosing**

Chemicals are added throughout the process to assist with the treatment by enhancing the removal of contaminants and control conditions. Chemicals are dosed from tanks located in the Biosolids Treatment building (original WWTP building).

#### **2.4.4.8.1 Alum Dosing**

Alum will be dosed at the entrance to the SBR tanks to assist in the phosphorus removal. The alum will be dosed by two pumps (one duty, one standby). The pumps will be positive displacement metering pumps. A 25 mm PVC line running to the entrance of the SBR tanks prior to the AAS will be the feed line.

#### **2.4.4.8.2 Polymer System**

Polymer will be dosed to the digested biosolids prior to thickening and dewatering.

### **2.4.5 Phase I Works Interim Equipment**

During the interim operation between the Phase I works and Phase II works, there will be temporary primary treatment equipment and temporary disinfection equipment in place. This interim equipment will be housed in the new Headworks Building and will remain in operation until the Phase II works are complete

#### **2.4.5.1 Interim Primary Treatment**

The proposed primary treatment process is a belt filter press provided by Salsnes. The intent of this equipment is to provide a level of primary treatment for the Town until funds can be made available to complete the remainder of the WWTF that includes secondary treatment. The belt filter press is anticipated to remove 25% BOD and 50% TSS.

The equipment is generally fully automated and self-cleaning. The dewatered solids will be collected in a solids bin and the operators will be required to empty the bin for disposal at the landfill site; similar to current practice with the sludge. These dewatered solids will be raw sludge and should be handled accordingly.

The equipment will require hot wash-down water, thus a series of hot water tanks supplemented by an instantaneous heater will be provided in the new Headworks Building to accommodate the demand.

#### **2.4.5.2 Interim Disinfection Equipment**

For interim disinfection, a temporary chlorine contact tank(s) will need to be constructed as the existing contact chamber (and Parshall flume) will need to be removed for construction of the Phase II works. Chlorine dosing will be provided by liquid sodium hypochlorite with 30 minutes contact time, followed by de-chlorination with liquid sodium bisulfite prior to discharge to the outfall.

### **2.4.6 Civil Works**

The new WWTF will be located on the existing sewage treatment plant site. Part of the Phase I work will include the construction of a new Headworks building that will house the inlet chamber, screening and grit removal systems. The new Headworks Building will be located southeast of the existing plant at the location of an existing storage garage. This garage will need to be removed, and the outdoor storage area utilized by the Town Public Works Department will be relocated.

Phase II work will extend the Headworks Building to take over most of the site behind the existing plant. Appendix C shows the site plans and proposed new building(s). The existing treatment building will be converted to house the aerobic digesters for biosolids treatment. The site plans also show that the existing force main will be extended to the new Headworks building. The effluent line from the new Headworks building will need to be re-routed around the existing facility so it can remain in operation during construction of the Phase II building extension. Piping will also be installed between the new and old building for sludge transfer and water re-use lines.

With the new septage receiving station to be incorporated into the Phase II works, the site will also have to have designated truck access for the haulers to enter and leave.

#### **2.4.6.1 Geotechnical Investigation**

A geotechnical investigation was completed by TREK Geotechnical Ltd. The investigation found that the soils were mostly sand, with some clay seams down to a clay till layer at approximately 6.5 m. The report also noted that there is a high water table in the area, with sloughing at around the 2.0 m depth mark. Piezometers were installed and show the static water level at around 2.0 m below grade.

This high ground water poses some challenges with buried tankage, and results in additional construction costs for dewatering. The Detailed Design of the structural foundation will likely require elevated tankage with a foundation base slab bearing on the soils above the ground water level.

The current proposed hydraulic profile has the SBR tankage buried at 2.5 m, as opposed to 5.0 m, to avoid the high groundwater. As a result, the new Headworks building is an additional 2.5 m taller to accommodate the raised hydraulic profile.

#### **2.4.6.2 Access Road and Parking**

Access to the new WWTF will continue to be provided from Chester Street East. An existing gravel parking lot on the north side of the current WWTP will be maintained for the operator and visitor parking.

#### **2.4.6.3 Drainage**

Site drainage will be required to ensure the site drains properly. Weeping tile will be installed around the subgrade structures to protect them from differential settlement due to varying groundwater levels.

#### **2.4.6.4 Outfall Alignment**

The existing outfall structure will continue to be used once the future treatment system is online. New effluent lines and a manhole to connect the future treated effluent to the existing outfall will be constructed on-site. The existing outfall pipe is 300 mm in diameter and discharges at an elevation of 433.45 m. The head at the final effluent holding tank will be sufficient for gravity drainage of the effluent to Gopher Creek. The proposed site plan shows the functional layout of the effluent lines and existing outfall structure. Connection options through manhole and concrete structures will be reviewed during detailed design.

A Parshall flume after the UV disinfection will meter the discharge volume of the plant.

#### **2.4.7 Structural Works**

The new WWTF will consist of a Headworks building, and attached concrete tankage for equalization tanks and SBR basins. The building will also house the concrete channels for the UV units and likely a Parshall flume. The original plant will also require some structural upgrades to install the new tankage for the aerobic digesters. A slab on grade link structure will connect the new building and the old building.

As the facility is in an industrial area, it is not anticipated that the structure will require significant architectural features. The exterior finishes will consist of metal siding, with potentially some concrete block. Colours and rooflines will be taken from the examples of the Main lift station and existing WWTP.

Each structure will be designed based on the National Building Code of Canada 2010 (NBCC) with the following loading for post-disaster buildings:

- Snow Loading –  $S_s=1.5$  kPa,  $S_r= 0.1$  kPa.
- Wind Loading –  $q_1/10= 0.38$  kPa,  $q_1/50= 0.49$  kPa.
- Floor Loading – Live Load = 4.8 kPa plus additional loading for equipment or fluid loading as required.

Reinforced concrete will be designed in accordance with CSA A23.3 “Design of Concrete Structures”, ACI 350 “Environmental Engineering Concrete Structures”, and the PCA Guidelines for “Rectangular Concrete Tanks” and “Circular Concrete Tanks without Prestressing”. The compressive strength of the structural concrete will be 32 MPa at 56 days, with sulphate resistant cement and Grade 400 deformed reinforcing bars. The concrete design will attend to water tightness and minimize shrinkage. Water tightness criteria will be to limit concrete crack width to 0.2 mm based on British Standard BS 8007. All construction joints in water retaining structures will include PVC waterstops.

Any masonry walls will be designed in accordance with CSA S304.1 “Design of Masonry Structures”. It is anticipated that 190 mm thick Concrete Masonry Units will be used to construct all exterior and interior walls.

Below grade structures will be backfilled with granular backfill and will utilize perimeter drainage systems. With the high water table, it is anticipated that the raft slab foundations will be placed relatively shallow (less than 2.0m).

##### **2.4.7.1 Headworks Building**

The approximately 20.0 x 20.0 m Headworks building will generally consist of a cast in place main floor and second floor, with concrete masonry unit (CMU) walls around the second floor area. The main floor walls will be cast in place concrete to accommodate the screening and grit removal equipment as well as the influent channels. The floor will utilize a 150 mm thick concrete slab on grade, with perimeter foundation walls and strip footings down to a minimum depth of 2.0 m to avoid frost heave. The exterior



walls and roof of the building will be clad in metal cladding. Walls will be insulated to R20 rating. The ceiling will be insulated to R40 rating. A crane and hoist will be provided for installation, removal and maintenance of large pieces of equipment.

The building will be a two storey structure, and will also include the septage receiving tankage and interim disinfection channel as cast in place tanks below the main floor.

To accommodate the future SBR tankage, the Headworks building will incorporate an extension of its tankage and foundation for the tie in of the future attached concrete structure.

#### **2.4.7.2 Sequencing Batch Reactors, Equalization Tanks and UV Disinfection**

These units will generally consist of rectangular concrete tankage submerged partially below grade. It is anticipated the tanks will be 6.5 m tall with 350 mm thick walls supported on a 400 mm concrete raft foundation. Generally, this tankage is expected to be open above the concrete cover, (no roof). Removable covers will be placed over the tankage openings that are exposed to the environment. The open area will be enclosed by galvanized or aluminum railings along the perimeter and access openings.

The blowers and equipment for the SBRs, as well as the UV disinfection equipment, will be enclosed in a storage building attached to the end of the SBR tankage

#### **2.4.7.3 Aerobic Digester**

The aerobic digester will be a concrete tank cast into the existing tankage area of the original facility. A further structural review of the existing facility will be required once the equipment has been removed to determine any additional reinforcing required for the bearing on the exiting floor. An aluminum hatch will provide access to the concrete tank for maintenance

#### **2.4.7.4 Sludge Holding Tank**

The sludge holding tank (WAS from SBRs) will be an approximately 50 m<sup>3</sup> concrete tank. It is anticipated that it will be substantially buried and have a wall and base slab thickness of 300 mm. This tank may be located below the UV disinfection area of the building.

#### **2.4.7.5 Sludge Pumping Station**

The sludge pumping station will consist of a rectangular concrete tank buried below grade. A stairwell access structure will be provided.

#### **2.4.7.6 Blower and Control Room Building**

The approximately 20.0 x 6.0 m Blower and Control Room building will consist of wood roof trusses bearing on CMU walls. The floor will utilize a 150 mm thick concrete slab on grade, with perimeter foundation walls and strip footings down to a minimum depth of 1.2 m. The exterior walls and roof of the building will be clad in metal cladding. The blower and control rooms will be separated by a CMU wall and

have separate exterior doors. Exterior walls will be insulated to R20 rating. The ceiling will be insulated to R40 rating. A crane and hoist will be provided for installation, removal and maintenance of large equipment items.

#### **2.4.7.7 Existing Facility Retrofits**

It is the intent to remove internal tankage and equipment once the Phase I project is complete. With the equipment removed, a structural assessment can be made of the existing concrete and building. The assessment will be used to appropriately design the new tankage to be placed for the aerobic digestion tanks and blower equipment.

#### **2.4.8 Building Mechanical Systems**

Building mechanical components will include HVAC, plumbing and fire protection systems. The design will be in accordance with the following codes and guidelines as required:

- National Building Code of Canada.
- National Fire Code of Canada.
- National Plumbing Code of Canada.
- NFPA 820 Fire Protection in Wastewater and Collection Facilities.
- ASHRAE STD 62.1 Ventilation for Acceptable Indoor Air Quality.
- CSA B149.1 Natural Gas and Propane Installation Code.
- Manitoba Plumbing Code/Building Code
- The Recommended Standards for Wastewater Facilities (commonly known as The Ten States Standards)
- Ontario's Design Guidelines for Sewage Works

HVAC design criteria includes:

- Elevation: 440 m.
- Winter Design Temperature: -36°C.
- Summer Design Temperatures: DB 30°C, WB 22°C.

##### **2.4.8.1 Utilities**

Plant service water and utilities will be supplied to the facility. Natural gas service will be extended from Ashburton Street East to a new service entrance to the new Headworks facility. The meter and service line will be sized to suit the Headworks building as well as the building expansion for the Phase II works. Water service will be extended from the existing WWTP after the meter location

##### **2.4.8.2 Plumbing**

The existing laboratory and washroom facilities will be maintained in the existing plant. No washroom or laboratory is proposed in the new WWTF.

A combination safety shower eyewash station will be provided in the solids dewatering areas. Safety shower tempered water will be provided by means of a large gas fired water heater in the building. Plant service water will be provided to hose bibs in the building and drainage will run to a process collection sump. The Headworks building will be provided with hose bibs for wash down, with drainage to the process channels. The collected water will be pumped into the equalization tank ahead of the SBR tank.

### 2.4.8.3 Heating, Ventilation and Cooling

Ventilation rates for process buildings will be based on the requirements of the Canadian Electrical Code, NFPA 820 and ASHRAE STD 62.1 Ventilation for Acceptable Indoor Air Quality.

Table 2-20 below provides the ventilation requirements that will be finalized during the detailed design.

**Table 2-20  
 Ventilation Requirements**

Area	Air Change Rate (air changes/hour)		Area Electrical Classification
	Continuous	Intermittent	
Headworks Building	6	12 <sup>(1)</sup>	Class 1, Zone 1
Above SBR Tankage	3	12 <sup>(1)</sup>	Class 1, Zone 1
UV Building Area	3	6 <sup>(1)</sup>	Class 1, Zone 2
Blower Rooms	-	As required	Not classified
Existing Plant (Digester)	3	6 <sup>(1)</sup>	Not classified

<sup>(1)</sup> Air change rate only provided when space is occupied or when ambient temperature is above 10° C or if H<sub>2</sub>S or combustible gases are detected.

Indirect gas-fired air handling units will be used to supply tempered makeup air to the Headworks building. Air will be supplied at 10°C during the winter. An equal volume of air will be exhausted to the outside through a corrosion, spark resistant, explosion proof fan. Supplemental heat will be provided by explosion proof electric unit heaters. The solids dewatering/UV disinfection areas will be ventilated and heated similarly. Unit heaters will be gas-fired and explosion proof in required areas.

The sludge pumping station will be provided with fresh air using a supply fan with an electric or gas fired duct heater, and air will be exhausted by a fan. An electric unit heater will provide supplemental heat.

The blower and control room will be heated by gas-fired unit heaters or gas furnace, and a ductless split air conditioning system will provide cooling for the control room. The blower room will be ventilated by means of exhaust fans to remove blower heat rejection.

Heat recovery systems will be reviewed during detail design to determine the feasibility of capturing the excess heat from the blower room and using it to provide supplemental heating to the Headworks building.

#### **2.4.8.4 Odour Control**

The two areas of the facility where significant odour will be generated are the Headworks and the solids dewatering areas. These areas will be enclosed buildings and so odour is not expected to become a public irritant. However, provision will be made to collect foul air from both of these buildings in case odour control is required in the future. Initial build-out of the facility will include ducts for collecting foul air. If odour is determined to be an issue, the ducts can be routed to an earthen biological filter for treatment of the odour causing compounds. The biological filter would be composed of woodchips and other bulking agents to provide an environment that promotes microbial activity. Foul air would be passed through the bottom of the filter where microorganisms would oxidize the odour causing compounds before the air is passed through the top of the filter into the atmosphere. Experience with similar filters in Alberta and British Columbia indicates that these filters are effective throughout the winter months.

#### **2.4.8.5 Fire Protection**

Portable fire extinguishers will be provided throughout the plant to meet the minimum requirements of the NBCC and NFPA. The code requirements for fixed fire suppression will be evaluated during the detailed design phase.

#### **2.4.9 Electrical Systems**

##### **2.4.9.1 Hazardous Area Classification**

The Headworks building will be classified as a hazardous location (due to explosive gases) as well as a corrosive location and a wet location. Equipment in this area will be rated for these conditions, and wiring will generally be TECK cable with explosion proof fittings.

The blower and control room building will be an ordinary dry area. Electrical equipment for power distribution and process control will primarily be located here. Electrical and communication services will come to this building. The MCC (motor control center), the main control panel, and the HMI (human machine interface) will be located here.

Materials and methods used in the solids dewatering areas will be suitable for a wet and corrosive environment.

Sensors will be used to monitor levels of CH<sub>4</sub> (methane) in hazardous locations, and levels of H<sub>2</sub>S (hydrogen sulfide) and O<sub>2</sub> (oxygen), in locations where the atmosphere could become hazardous to operators.

A fire alarm system will be implemented where the Building Code and standard NFPA 820 so indicate.

##### **2.4.9.2 Service Requirements**

A 347/600V, three phase, four wire electrical service will be requested from Manitoba Hydro. The anticipated service size is 800A, allowing for the planned loading and permitting some future load growth.

An MTS service is anticipated and will be extended from the existing plant MTS panel.

#### **2.4.9.3 Standby Power**

A diesel standby genset and an automatic transfer switch will provide standby power in the event of a utility outage at the site. A genset with a standby rating of 100 kW will be installed to accommodate the Phase I Headworks building. A second genset will be installed under the Phase II works to accommodate the additional load requirements for the remainder of the equipment.

#### **2.4.9.4 Surge Protection**

The main service will be protected with lightning arrestors and transient voltage surge suppressions (TVSS). This protective equipment will be located at the main service location, and will offer protection to electronics and sensitive loads from surges due to external transients from lightning and utility switching. UPS and power supplies for PLCs will provide further protection for specific loads. Communication services entering buildings will also be provided with surge protection.

#### **2.4.9.5 Lighting**

Interior lighting will generally be T8 fluorescent vapour tight fixtures in most areas, and explosion proof fixtures in hazardous locations. Lighting levels of 300 lux to 500 lux (30 to 50 fc) will be targeted for buildings. Outdoor lighting will primarily be by building mounted fixtures, with lighting levels to IESNA (Illuminating Engineering Society of North America) levels for basic security lighting targeted in walkways and parking areas. Wall packs on the building will be used where augmented lighting is needed.

#### **2.4.10 Instrumentation and Controls**

##### **2.4.10.1 Controls Architecture**

Packaged process equipment will come as systems, complete with instrumentation. Additional instrumentation will be provided for monitoring and control of the process between the packaged pieces, and for monitoring and controlling building systems that are not part of the process (such as monitoring gas levels, monitoring building temperatures, and controlling heating and ventilation equipment).

A local control panel and interface will be provided in the building. This local control panel will communicate with the packaged controls of the various process equipment packages, and will monitor loose instrumentation and control buildings systems. Data from process and building systems will be collected at the local control panel for monitoring, control, trending, reviewing and reporting. This control panel will have capacity for additional future I/O and programming, and will be accessible for factory viewing, diagnostics or programming via the telephone system.

Major pieces of equipment will have manual control available in addition to automatic controls

#### **2.4.10.2 Alarms**

Comprehensive alarming will be implemented. Alarm conditions from the process, process equipment in fault modes, buildings systems and backup systems will be monitored by PLC. On an alarm condition, the control system will respond depending on the severity of the condition. On the highest priority events, local alarms will sound and communications will go out calling for operators to attend the plant. Lower priority conditions can be configured to transmit an alert or warning communication or to generate local alarms or warnings only. Alarm conditions will be time stamped and logged.

#### **2.4.10.3 SCADA**

Controls and alarms at the WWTF will be tied into a new supervisory control and data acquisition SCADA system. The SCADA system will coordinate processes that are controlled by the operator at the human machine interface (HMI).

#### **2.4.10.4 HMI**

A graphic interface will be provided, offering screens with site and process overviews and control, as well as detailed views of equipment, process variables, totalizers, setpoints, trending, run times, and alarms. Passcode protection will be available, allowing different levels of accessibility and control for different users to be implemented.

#### **2.4.11 Construction**

Given the existing site constraints at the Virден WWTP, the only feasible location to construct the new liquid treatment train is to the south of the existing facility. The area consists of a large open area and one shed. The Town currently use this area as a storage site. All other options not located on the current Virден WWTP site would require relocation of existing underground structures and would cost substantially more than the current location.

##### **2.4.11.1 Commissioning**

###### **2.4.11.1.1 Phase I Works**

The construction of the Phase I works will be executed in such a manner that it will have minimal impact on the current operations of the existing wastewater treatment plant.

When the Phase I works are complete and ready for use, the force main will be diverted to the new Headworks building. Commissioning will involve confirming the proper operation of the instrumentation (flow and level), the screening equipment, the grit removal equipment, the belt filter press, and disinfection systems. Any initial failure of this equipment could result in diverting the flow back to the existing wastewater plant. Commissioning will also involve close monitoring of the operations over a two week period with the Contractor and Equipment suppliers. After fourteen (14) days of operation without equipment or control issues, the plant will be turned over to the Town for their staff to begin operating.

Although the operating staff has previous experience with similar equipment from the original plant, they will still require some supplemental training on equipment specifics prior to the completion of the project.

With the completion of the Phase I project, the existing wastewater plant can be fully by-passed. The existing lab and office will be maintained and updated; however, the existing treatment equipment will be available for demolition and decommissioning.

#### **2.4.11.2 Phase II Works**

Phase I is designed so that the construction of Phase II can be executed with minimal impact to operations. Once the Phase II works are complete and ready for use, the flow after the grit removal system will be diverted to the new SBR basins. The commissioning procedure will be similar to that of the Phase I work, however the demonstration period will be increased to thirty (30) days.

#### **2.4.12 Decommissioning**

The design life of the Virден WWTF project, based on the design population criteria used to size the facility, is twenty (20) years. Given the uncertainty associated with future wastewater treatment technologies, no specific decommissioning plans are included in the current Functional Design. It can be expected that the plant will likely undergo another round of upgrading at a point near the end of the project design life. Full-scale decommissioning of the project site is not anticipated.

Part of the WWTF Upgrade work program will include the removal of the existing tankage in the old wastewater treatment plant to allow new sludge digestion and handling equipment to be installed. The work will also include the decommissioning and abandonment of the defunct deep shaft. As this shaft is similar in nature to a water well, similar practices to water well abandonment will be implemented in its decommissioning. The Contractor responsible for the work will be required to submit a plan to Manitoba Conservation and Water Stewardship for their approval.

Prior to the decommissioning of the existing equipment, this will be dictated by the schedule of Phase II construction, a decommissioning plan will be submitted for review detailing how the equipment will be removed and where it will be disposed of.

## 2.5 PROJECT SCHEDULE

The project schedule is outlined in Table 2-21 below.

**Table 2-21  
Virден WWTF Upgrade Project Schedule**

<b>Project Component</b>	<b>Start</b>	<b>End</b>
Environment Act Licensing	December 1, 2013	May 1, 2014
<b>Phase I Works</b>		
Detailed Design	November 2013	February 28, 2014
Tendering	March 3, 2014	March 21, 2014
Construction	April 7, 2014	October 17, 2014
Commissioning	October 20, 2014	November 14, 2014
<b>Phase II Works <sup>(1)</sup></b>		
Detailed Design	September 2014	February 2015
Tendering	March 2015	March 2015
Construction	April 2015	April 2016
Commissioning	May 2016	May 2016

<sup>(1)</sup> *Dependent on funding availability.*

## 2.6 FUNDING

### 2.6.1 Phase I Works

The Town of Virден has partnered with the Manitoba Water Services Board (MWSB) to design and construct the Headworks building with Primary Treatment, referred to as Phase I work. The funding amount is approximately \$4.0M for design, financing and construction; 50% financed by the Town and 50% financed by the MWSB.

### 2.6.2 Phase II Works

Phase of the works will be the design and construction of the remaining treatment infrastructure; SBR basins, UV disinfection, sludge digestion, septage hauling, and SCADA automation. The timing of this phase of works is dependent on the availability of funding from the Federal Government and Provincial Government. The opinion of probable cost for the Phase II works is \$9.0M for design, financing, and construction.



## **2.7 PUBLIC CONSULTATION**

A public consultation session was held in the Town of Virден on October 23, 2013 to communicate the results of the Functional Design Study to the citizens of the Town and R.M. of Wallace. A total of twenty-one people attended the open house, including representatives of the Town, the engineering consultant (AE) and the environmental consultant (EGE).

A questionnaire was provided and the responses received are included in Appendix D. The contact information has been redacted from the sign in sheet and comment sheets for privacy reasons. Based on the responses received and discussions held with those attending, there were no significant concerns with respect to the environmental impact of the WWTF Upgrade Project. Most respondents and/or interviewees suggested that this WWTF Upgrade Project would improve environmental conditions in Gopher Creek, and therefore, had a positive opinion on the project from an environmental perspective.

## **3.0 ASSESSMENT APPROACH**

### **3.1 GEOGRAPHIC BOUNDARIES**

The project site includes any land that will be disturbed by project activities. The project site is confined to the property limits of the current Virден WWTP since all construction activities will take place within the current property boundary.

The project area includes any area, up to 5 km beyond the project site, which could be disturbed by project effects. This would include effects during construction (noise, vehicle movement, emissions, etc.), operation (effluent discharge) and decommissioning. In particular, the project area includes the effluent discharge channel and outlet to Gopher Creek, and Gopher Creek upstream and downstream of the outlet within the 5 km boundary.

The project regional study area includes any area beyond the project area that may be affected by the construction, operation or decommissioning activities of the project. In particular, this includes the remainder of Gopher Creek downstream of the project area to the Assiniboine River, and the Assiniboine River.

### **3.2 TEMPORAL BOUNDARIES**

The assessment considered the period from the start of construction to decommissioning the new WWTF. This period is anticipated to be 2014 - 2041. The temporal boundaries of the assessment were divided into the construction, operation and decommissioning phases as follows:

- Construction of Phase I - March 2014 to December 2015;
- Construction of Phase II - March 2015 to March 2016;
- Operation of Phase I - January 2015 to March 2016;
- Operation of Phase II - April 2016 to 2033 and beyond;
- Decommissioning of the existing plant – March 2015 – March 2016

### **3.3 ENVIRONMENTAL COMPONENTS**

The environmental assessment considered the existing environment, with the current Virден WWTP operation as the baseline condition. The environmental components were organized into the following categories:

- Physical Environment (air quality, climate, topography, geology, soils, surface water and surface water quality, hydrogeology and groundwater);
- Terrestrial Environment (vegetation, wildlife and protected species);
- Aquatic Environment (aquatic resources and habitat);
- Socio-Economic Environment (land-use and transportation);

- Heritage and Cultural Resources; and
- First Nations.

### **3.4 PROJECT-ENVIRONMENT INTERACTION**

The project-environment interaction matrix is illustrated in Table 3-1, and identified the work and activities associated with the Project that may affect the environment. Predicted changes to the environment caused by the Project were assessed against the existing baseline conditions.

### **3.5 MITIGATION MEASURES**

Mitigation measures have been presented in association with the assessment of potential effects and may be supplemented with additional measures during the Detailed Design phase of the Project.

**Table 3-1  
 Potential Project-Environment Interaction Matrix**

Project Phases and Components	Environmental Components													
	Physical						Terrestrial and Aquatic			Socioeconomic			Heritage - Cultural Resources	
	Air Quality	Noise	Climate	Geology	Soils	Surface Water	Groundwater	Vegetation	Wildlife	Fish and Fish Habitat	Land Use	Transportation		Recreation and Tourism
<b>Construction</b>														
Site preparation, staging and laydown areas	○	○	○	○	○	○			○	○	○	○		○
Phase I Headworks construction	○	○	○	○	○	○	○		○	○	○	○		○
Phase II SBR construction	○	○	○	○	○	○	○		○	○	○	○		○
Disposal of construction waste	○	○	○								○	○		
Site re-grading and restoration	○	○	○	○	○	○			○	○	○	○		
<b>Operation</b>														
Phase I Headworks	○	○	○								○	○	○	
Phase I discharge of treated effluent	○					○	○	○	○	○	○		○	
Phase II SBR											○	○	○	
Phase II discharge of treated effluent	○					○	○	○	○	○	○		○	
Disposal of biosolids	○	○	○	○	○	○	○	○	○	○	○	○		
Fuel and chemical storage/use	○		○		○	○	○	○	○	○	○	○		

Project Phases and Components	Environmental Components												
	Physical						Terrestrial and Aquatic			Socioeconomic			Heritage - Cultural Resources
	Air Quality	Noise	Climate	Geology	Soils	Surface Water	Groundwater	Vegetation	Wildlife	Fish and Fish Habitat	Land Use	Transportation	
<b>Accidents and Malfunctions</b>													
Fuel and chemical spills	⊙				⊙	⊙	⊙	⊙	⊙	⊙	⊙	⊙	⊙
Fires and explosions	⊙	⊙	⊙		⊙	⊙	⊙	⊙	⊙	⊙	⊙	⊙	⊙
Power failures	⊙												
Malfunction of process equipment	⊙		⊙		⊙	⊙	⊙	⊙	⊙	⊙	⊙	⊙	⊙
Transportation accidents	⊙				⊙	⊙	⊙	⊙	⊙	⊙	⊙	⊙	⊙
Pipeline failure	⊙			⊙	⊙	⊙	⊙	⊙	⊙	⊙	⊙	⊙	⊙
Tankage failure/leakage	⊙				⊙	⊙	⊙	⊙	⊙	⊙	⊙	⊙	
<b>Decommissioning</b>													
Solid Waste Disposal	⊙	⊙	⊙		⊙							⊙	
Rehabilitation of site	⊙	⊙	⊙		⊙	⊙	⊙	⊙	⊙	⊙	⊙	⊙	

### 3.6 SIGNIFICANCE OF RESIDUAL ADVERSE EFFECTS

After the application of mitigation measures, any residual adverse effects were identified in order to determine their significance. The assessment considered the nature and magnitude of the residual effect along with its temporal characteristic and spatial boundaries. If the effects were significant, the assessment also included the likelihood of potential effects occurring and any associated uncertainty in terms of the prediction of the effect. Table 3-2 summarizes the factors and definitions used to assess the environmental effects.

**Table 3-2  
 Assessment of Environmental Effects and Determination of Significance**

Factor	Definition
Magnitude	Small - Effect is unlikely to be detectable or measurable; or below established thresholds of acceptable change; or within range of natural variability; or minimal impairment of ecosystem component's function.
	Moderate - Effect could be detectable with the normal range of a monitoring program; or effect is marginally beyond guidelines; or effect is beyond the range of natural variability; or effect is marginally beyond minimum impairment of the ecosystem component's function.
	Large - Effect is readily detectable without a monitoring program; or well beyond guidelines; or well beyond the range of natural variability; or well beyond minimal impairment of the ecosystem component's function
Geographic Extent	Project Site - within the project site.
	Project Area - beyond the project site but within the project area.
	Regional - beyond the local project area but within the regional study area
Duration	Short-Term - generally within the construction period; or within one generation of the recovery cycle.
	Medium-term - transition period during the operational phase; or within one or two generations or recovery cycles.
	Long-term - long term during the operational phase or permanent; or two or more generations or recovery cycles.

The combination of the three factors (magnitude, geographic extent and duration) used to determine the significance of any residual effect is shown in Table 3-3.

**Table 3-3  
 Combination of Factors to Determine Significance of Residual Effects**

Magnitude	Geographic Extent	Duration	Combination is Significant
Large	Regional	Long-term	⊙
		Medium-term	⊙
		Short-term	⊙
	Local	Long-term	⊙
		Medium-term	⊙
		Short-term	
	Site	Long-term	⊙
		Medium-term	
		Short-term	
Moderate	Regional	Long-term	⊙
		Medium-term	⊙
		Short-term	
	Local	Long-term	⊙
		Medium-term	
		Short-term	
	Site	Long-term	
		Medium-term	
		Short-term	
Small	Regional	Long-term	
		Medium-term	
		Short-term	
	Local	Long-term	
		Medium-term	
		Short-term	
	Site	Long-term	
		Medium-term	
		Short-term	

## 4.0 ENVIRONMENTAL SETTING

### 4.1 PHYSICAL ENVIRONMENT

#### 4.1.1 Air Quality

There is no ambient air quality data for the Virden WWTF location and no continuous air quality monitoring is conducted in the Virden area. The nearest Manitoba Conservation air quality monitoring station is located in the City of Brandon at the Assiniboine Community College. This station is chosen as representative of the western Manitoba region, including Virden.

Air quality data for the City of Brandon is available for the following parameters: nitrogen dioxide (NO<sub>2</sub>); nitric oxide (NO); nitrogen oxides (NO<sub>x</sub>); oxidants ozone (O<sub>3</sub>); ammonia (NH<sub>3</sub>); and inhalable particulate matter (PM) in the respirable suspended range 10 micrometres or less (PM<sub>10</sub>) and fine particle range 2.5 micrometres or less (PM<sub>2.5</sub>). Table 4-1 provides a general summary of the yearly average annual air quality data from 2000 to 2010 provided by Manitoba Conservation <sup>(4)</sup> as well as the calculated average over the eleven year period.

**Table 4-1  
 Ambient Air Quality for the Brandon Area**

Parameter	2000	2001	2002	2003	2004	2005	2006	2007	2008	2009	2010	Average
NO <sub>2</sub> (pphm)	0.69	0.52	0.58	0.61	0.54	0.53	0.50	0.56	0.53	0.54	0.46	0.55
NO (pphm)	0.38	0.49	0.32	0.35	0.41	0.36	0.25	0.71	0.40	0.34	0.23	0.39
NO <sub>x</sub> (pphm)	0.96	0.98	0.91	0.96	0.94	0.88	0.74	1.26	0.93	0.88	0.74	0.93
O <sub>3</sub> (pphm)	2.58	2.64	2.70	2.77	2.22	2.19	2.70	2.50	2.62	2.28	2.56	2.52
NH <sub>3</sub> (ppm)	0.01	0.02	0.01	0.01	0.00	0.02	0.02	0.00	0.02	0.01	0.10	0.02
PM <sub>10</sub> (ug/m <sup>3</sup> )	19.8	22.3	21.9	23.3	20.8	19.7	22.3	23.4	23.8	21.5	21.2	21.82
PM <sub>2.5</sub> (ug/m <sup>3</sup> )	-	5.8	5.2	6.0	5.0	4.70	5.52	4.78	5.1	4.51	4.72	5.13

#### 4.1.2 Climate

Climatic normals are available for Virden from Environment Canada <sup>(5)</sup>. The daily annual average temperature at the Virden weather reporting station, for the period 1981 through 2005, was 3.1 degrees Celsius (°C). The hottest month is July, with a daily average of 19.2 °C, and the coldest month is January at -15.5 °C. Average annual rainfall is 355.5 mm and average annual snowfall is 123.2 cm. The total average annual precipitation is 473.9 mm. In terms of precipitation, the wettest month is June, at 82.2 mm, and the driest month is February, at 12.6 mm. The mean length of the frost-free period is 118 days.



**Table 4-2  
 Canadian Climate Normals (1981 - 2005) - Virden, Manitoba**

Temperature	Jan	Feb	Mar	Apr	May	Jun	Jul	Aug	Sep	Oct	Nov	Dec	Year
Daily Average (°C)	-15.5	-11.4	-5.0	4.4	11.5	16.4	19.2	18.4	12.2	4.8	-5.0	-12.8	3.1
Daily Max (°C)	-10.3	-6.3	-0.1	10.8	18.3	22.6	25.5	25.1	18.6	10.7	-0.4	-8.0	8.9
Daily Min (°C)	-20.6	-16.5	-9.8	-2.0	4.7	10.2	12.8	11.7	5.8	-1.0	-9.5	-17.6	-2.7
Rainfall (mm)	0.3	0.7	8.3	15.8	49.4	82.2	66.7	62.1	40.1	23.3	5.7	1.0	355.5
Snow fall (cm)	22.4	12.7	18.9	13.3	4.7	0.0	0.0	0.0	0.5	9.1	18.3	23.4	123.2
Precipitation (mm)	21.1	12.6	26.7	28.6	54.1	82.2	66.7	62.1	40.5	32.2	23.9	23.2	473.9

#### 4.1.3 Physiography and Landscape

The Virden WWTF project is located within the Prairies Ecozone, Aspen Parkland Ecoregion <sup>(6)</sup>. The Ecoregion is underlain by Cretaceous shale bedrock almost entirely covered by undulating, calcareous, loamy glacial till or glacial lacustrine sediments. Drainage is essentially eastward. Native vegetation consists of mixed wheat grass and fescue prairie, associated with aspen and bur oak groves. Deciduous shrubs and herbs are an important part of most communities. Slough grass, sedges, cattails and willows are found in depressions, and surrounding lake margins. Most of the better drained land has been converted into farmland. The soils are predominantly Black Chernozems on glacial till and sandy lacustrine deposits, with Humic Gleysols in poorly drained depressions and Regosols on eolian sand deposits.

The Virden area is located at the junction point of a number of Ecodistricts: St. Lazare; Melville; Hamiota; Stockton; and Oak Lake. Virden lies at the southern tip of the St. Lazare Ecodistrict. The Melville Ecodistrict is located to the west and northwest of Virden, while the Hamiota Ecodistrict is located north and northeast of the Town. The Oak Lake Ecodistrict is located south of Virden. The Stockton Ecodistrict contains the Assiniboine River valley.

The St. Lazare Ecodistrict is located within the Grassland Transition Ecoclimatic Region that lies between the driest subdivision to the southwest and the most humid subdivision to the east in the Manitoba Plain. The ecodistrict generally consists of subdued undulating to hummocky till plain dissected by broad river valleys (including the Assiniboine River). Outside of the river valleys, the terrain is level to gently sloping. Natural vegetation consists of grassland species interspersed with trembling aspen groves, but most of the natural vegetation has been removed for cultivation. Cultivated soils are used for production of spring wheat, other cereal grains, oil seeds and hay crops.

##### 4.1.3.1 Topography

The Virden WWTF project site is at 434 m above sea level (asl) and is relatively flat. Site drainage is currently provided by surface ditches along Third Avenue, Kent Street and Ashburton Street.

The elevation at the end-of-pipe discharge to the surface drainage channel is 434 m asl. The surface drainage channel drops to an elevation of 429 m over a distance of 175 m to the discharge point into

Gopher Creek. Gopher Creek drops to an elevation of 367 m at the confluence with the Assiniboine River, an elevation change of 62 m over 13.1 km for an average gradient of 0.5%. The slope flattens out once Gopher Creek enters the floor of the Assiniboine River valley. An elevation profile of Gopher Creek from the surface drainage channel outfall to Assiniboine River is provided in Plate 4-1 below.

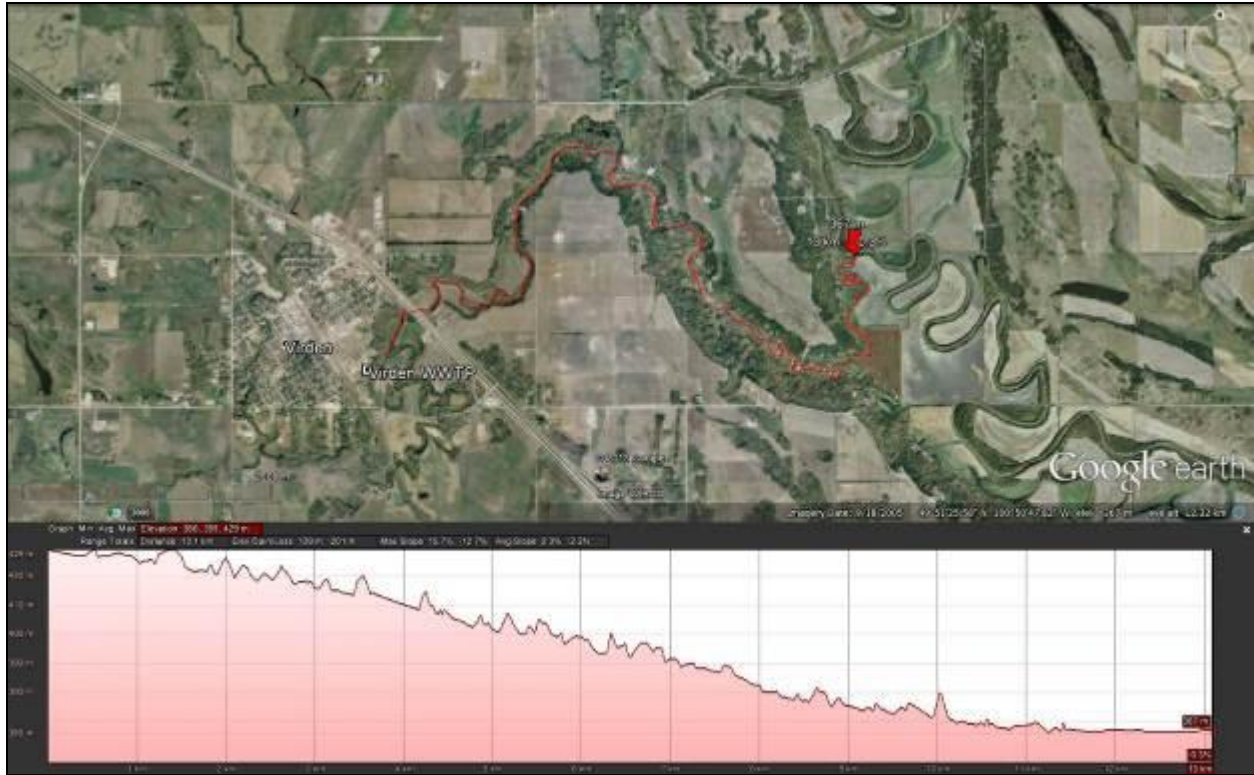

Plate 4-1: Elevation profile of Gopher Creek from drainage channel outfall to Assiniboine River.

#### 4.1.3.2 Geology

The regional geology consists of the Cretaceous age Riding Mountain Formation, and two members: the Odanah Member and Millwood Member. The Odanah Member is located below the Virден WWTP and consists of hard grey siliceous shale, with typical drift thicknesses of 20 to 40 m<sup>(7)</sup>. Immediately northeast of the Virден WWTP, a narrow band of the Millwood Member is present, consisting of soft greenish brown bentonitic silty shale. Before reaching the Assiniboine River, Gopher Creek transitions to the Odanah and Millwood Members once again.

The drift thickness in the Town of Virден is generally less than 20 m, but increases sharply to the north and east to about 100 m near the outlet of Gopher Creek into the Assiniboine River<sup>(7)</sup>. The bedrock elevation at the Virден WWTP is between 400 and 420 m above sea level (asl) and rises sharply to the north and east to about 350 m asl.

#### 4.1.3.3 Soils

The Virden area is underlain by distal glaciofluvial sediments, consisting of fine sand, minor gravel with thin clay and silt interbeds, typically between 1 and 75 m in thickness, and sub-aqueous outwash fans, deposited in glacial Lake Agassiz by meltwater turbidity currents, and commonly re-shaped by wave erosion and reworked by wind <sup>(8)</sup>. Surficial deposits along Gopher Creek and the Assiniboine River consist of alluvium and colluvium. Immediately west of Virden, the surficial deposits transition to sand and gravel from delta and beach deposits and till. Silt from lacustrine and aeolian deposits is predominant to the north of Virden.

The project area and project regional boundary downstream along Gopher Creek is rated by the Canada Land Inventory (CLI) Land Capability for Agriculture classification system as CLI 6, which indicates soils are capable only of producing perennial forage crops and improvement practices are not feasible <sup>(9)</sup>. The subclass T indicates topographic limitations due to steepness or the pattern of slopes. The more developed agricultural lands west and north of Gopher Creek are shown as CLI 5, indicating soils with very severe limitations that restrict their capability to producing perennial forage crops, however; improvement practices are feasible. The subclass S is shown, indicating soil limitations relating to factors such as low moisture holding capacity, salinity, and low natural fertility. The CLI map for the Virden area is shown on Plate 4-2 below.

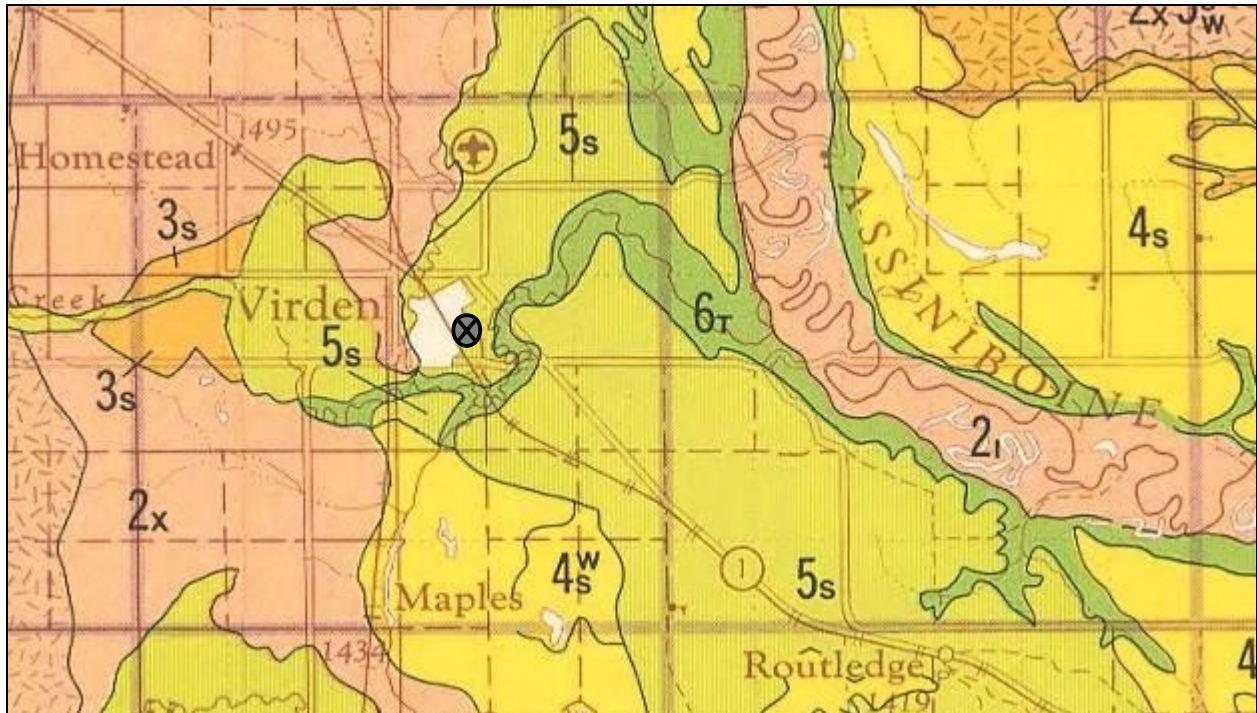

Plate 4-2: CLI Soil Capability for Agriculture in the Virden area.

Land in the Assiniboine River valley is rated CLI 2, indicating moderate limitations that restrict the range of crops or require moderate conservation practices. The subclass I indicates inundation (flooding) that limits agricultural use.

#### **4.1.4 Surface Water**

The Virден WWTF is located near the upper reaches of the Assiniboine River in the Arrow-Oak River Watershed. The watershed encompasses the area roughly from the Trans-Canada Highway north to Provincial Highway 45 and the Saskatchewan border east to nearly Brandon, as shown on Plate 4-3 below. The State of the Watershed report <sup>(10)</sup> indicates that the watershed is home to 10,000 people and covers approximately 526,000 hectares (1,300,000 acres).

To the north of Virден, Scallion and Little Scallion creeks converge and flow through the west side of Virден, before converging with Bosshill Creek near the southwest corner of the Town. Bosshill Creek then converges with Gopher Creek southeast of Virден, and Gopher Creek flows along the eastern edge of the Virден, then northeast, and southeast into the Assiniboine River, as shown on Plates 4-3 and 4-4.

Bosshill Creek has a gross drainage area of 188.0 km<sup>2</sup> and an effective drainage area (that portion that would contribute runoff to the main stream during a median runoff year, which is a 1:2 year event) of 97.6 km<sup>2</sup>. Gopher Creek has a gross drainage area of 298.1 km<sup>2</sup> and an effective drainage area of 167.8 km<sup>2</sup> <sup>(11)</sup>.

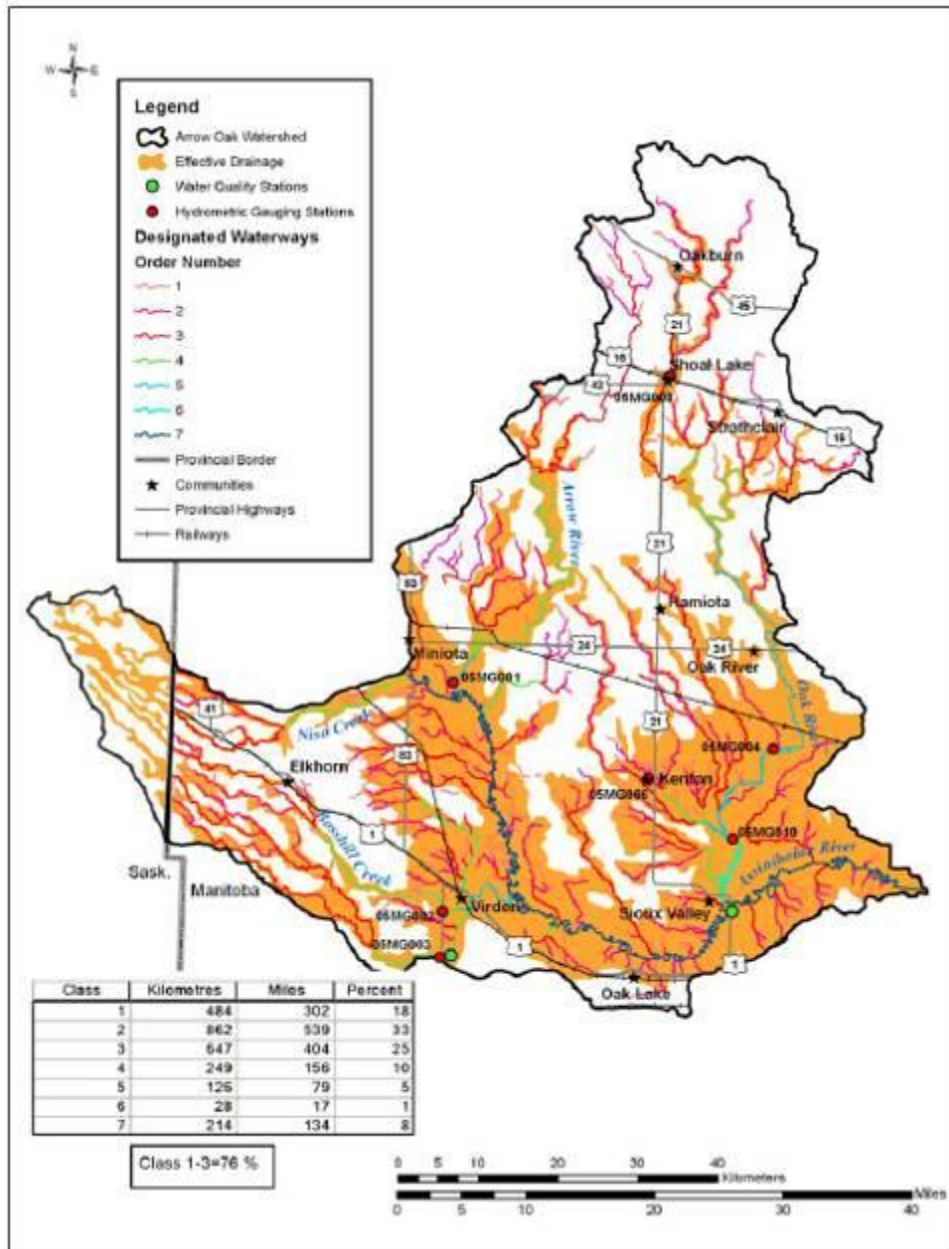

Plate 4-3: Arrow-Oak River Watershed boundary.

There are seven Water Survey of Canada stream flow gauging stations located in the watershed, not including those located on the Assiniboine River, including one on Bosshill Creek upstream from the Virden WWTF project site (05MG002) and one on Gopher Creek about 13.7 km upstream of the project site (05MG003), near Highway 83 (see Plate 4-4).



Plate 4-4: Location of hydrometric monitoring stations near Virden WWTF.

The monitoring station located on Bosshill Creek near Virden (05MG002) operated from 1959 to 1976. The station on Bosshill Creek is located 12.5 km upstream of the Virden WWTF project site where Provincial Highway 257 crosses Bosshill Creek. Bosshill Creek discharges into Gopher Creek upstream of the WWTF outfall location. Mean monthly flows over the eighteen year period of record are provided in Table 4.3 below <sup>(12)</sup>.

**Table 4-3**  
**Monthly Mean Discharge (m<sup>3</sup>/s) - Bosshill Creek Near Virden (05MG002) 1959 to 1976**

Year	Jan	Feb	Mar	Apr	May	Jun	Jul	Aug	Sep	Oct	Nov	Dec
Mean	-	-	0.13	1.39	0.21	0.08	0.09	0.01	0.02	0.04	-	-
Minimum	-	-	0.00	0.02	0.01	0.00	0.00	0.00	0.00	0.00	-	-
Maximum	-	-	0.66	7.09	0.76	0.50	0.68	0.05	0.15	0.20	-	-

As seen in Table 4-3, Bosshill Creek upstream of the Virден WWTF has experienced no discharge in most months on record, except April and May. The lowest mean discharge occurs in August, at 0.01 m<sup>3</sup>/s, and the highest discharge occurs in April, at 1.39 m<sup>3</sup>/s. These measurements were obtained prior to a control structure (described below) that was built directly upstream of the former monitoring station. Representative photographs of Bosshill Creek are provided below. All photographs were taken October 23, 2013.



*Photo 4-1: Bosshill Creek at PR 257 crossing.*



*Photo 4-2: Bosshill Creek at PR 257 crossing.*

Upstream of the Bosshill Creek crossing at PR 257, a control structure and impoundment is located within a Ducks Unlimited conservation area referred to as the John Clarke Memorial Legacy Greenwing Project. The control structure can be used to regulate flow on Bosshill Creek as it crosses under PR 257 and enters a golf course on the south side of the highway. Dykes have been constructed to create an artificial wetland feature. The structure provides a barrier to fish movement further upstream.



*Photo 4-3: Outlets from control structure on Bosshill Creek north of PR 257.*



*Photo 4-4: Inlet culverts on Bosshill Creek.*



*Photo 4-5: Artificial wetland (Ducks Unlimited).*



*Photo 4-6: Dyke at south end of wetland.*



*Plate 4-5: Control structure and artificial wetland on Bosshill Creek at PR 257.*

The hydrometric station on Gopher Creek (05MG003) has been in operation since 1959, and typically measures flow between March and October each year, except for the period from 1994 through 2009, when flows were only recorded in March, April and May. The monthly mean, minimum and maximum flows recorded during the period of record are summarized in Table 4-4 below<sup>(13)</sup>.



**Table 4-4**  
**Monthly Mean Discharge (m<sup>3</sup>/s) - Gopher Creek Near Virden (05MG003) 1959 to 2011**

Year	Jan	Feb	Mar	Apr	May	Jun	Jul	Aug	Sep	Oct	Nov	Dec
Mean	-	0.130	0.198	1.30	0.298	0.260	0.090	0.016	0.024	0.028	-	-
Minimum	-	0.130	0.000	0.000	0.000	0.000	0.000	0.000	0.000	0.000	-	-
Maximum	-	0.130	1.45	11.6	4.86	5.87	0.841	0.140	0.408	0.334	-	-

As shown in Table 4-4, Gopher Creek upstream of the Virden WWTF project site has seen zero discharge (no flow) in all months except February over the period of record. Mean discharge is lowest in August, at 0.016 m<sup>3</sup>/s, and highest in April, at 1.30 m<sup>3</sup>/s. There are no discharge measurements available for Gopher Creek downstream of the confluence with Scallion Creek, Little Scallion Creek and Bosshill Creek, all of which contribute flow to Gopher Creek above that which is reflected in Table 4-4 above. There are no discharge measurements for Gopher Creek downstream of the effluent drainage channel outlet location.

Mean effluent discharge from the Virden WWTP is estimated at 1,125 m<sup>3</sup>/day or 0.013 m<sup>3</sup>/s and remains relatively constant each month. Representative photographs of Gopher Creek, upstream of the Virden WWTF are provided below. As shown in the photographs, upstream of Virden, Gopher Creek is a shallow stream with very low banks and limited riparian vegetation. Agricultural use is common up to the edge of the creek.



*Photo 4-7: Upstream, Gopher Creek at 05MG003.*



*Photo 4-8: Downstream, Gopher Creek at 05MG003.*



*Photo 4-9: Upstream, Gopher Creek at PTH 83.*



*Photo 4-10: Downstream, Gopher Creek, PTH 83.*



*Photo 4-11: Upstream, Gopher Creek at PR 257  
in Virден*



*Photo 4-12: PR 257 bridge at Gopher Creek  
in Virден.*

Closer to Virден, after the confluence with Bosshill Creek and Scallion Creek, Gopher Creek becomes wider and deeper, with bank heights estimated between 3 and 5 m. Much more riparian vegetation is present in the absence of intensive agricultural land use.

Downstream of the Virден WWTF project site is an effluent drainage channel that discharges into Gopher Creek. The ditch flows for about 175 m before it enters Gopher Creek, which is located 225 m northeast of the current WWTF building. Gopher Creek flows northeast, then southeast, then north before it discharges into the Assiniboine River. The total distance from the end of the effluent discharge channel (at Gopher Creek) to the Gopher Creek discharge into the Assiniboine River is 13.1 km

Representative photographs of the effluent discharge channel from the end-of-pipe to Gopher Creek are provided below. The effluent drainage channel drops about 1.5 m over the last 12 m before entering Gopher Creek. Several cement blocks have been placed in the channel at the outlet to prevent erosion. Under normal and low flow conditions, aquatic life would not be able to enter the effluent drainage channel. A noticeable wastewater odour was present at the outlet location into Gopher Creek.



*Photo 4-13: Effluent drainage channel looking downstream from end-of-pipe.*



*Photo 4-14: Effluent drainage channel about 50 m downstream of end-of-pipe.*



*Photo 4-15: Effluent drainage channel looking upstream, about 125 m from end-of-pipe.*



*Photo 4-16: Discharge from effluent drainage channel into Gopher Creek.*

Representative photographs of Gopher Creek downstream from the effluent discharge channel outlet are provided below. Anecdotal evidence provided by a landowner with property adjacent to Gopher Creek indicated that downstream of the Trans-Canada Highway, the maximum depth of the creek is about 1.5 m in some places, but that generally, the creek is less than 1.0 m deep, and includes several sections of rapids. The Gopher Creek valley deepens north of the Trans-Canada Highway to about 6 to 9 m.



*Photo 4-17: Gopher Creek, looking upstream from effluent drainage channel outlet.*



*Photo 4-18: Gopher Creek, downstream from effluent drainage channel outlet.*



*Photo 4-19: Gopher Creek, looking upstream from PTH 1 south service road (545 m from outlet).*



*Photo 4-20: Gopher Creek, looking at PTH 1 south service road crossing.*



*Photo 4-21: Gopher Creek at north PTH 1 service road crossing, looking west (700 m from outlet).*



*Photo 4-22: Gopher Creek, looking at ford crossing north of PTH 1 service road.*



*Photo 4-23: Gopher Creek, looking downstream, approximately 3.1 km downstream of the effluent drainage channel outlet.*

The majority of runoff in the watershed occurs from March to May, and very little flow is apparent on Gopher and Bosshill Creeks during the summer, fall and winter months. The two creeks are considered to be intermittent prairie streams, in that they flow very briefly in the springtime and only after heavy rainfalls in most years. Peak flow has only occurred four times outside of the spring period for Gopher Creek (in summer) and one time for Bosshill Creek.

The nearest monitoring station on the Assiniboine River for which data is available is located south of Miniota at the Provincial Highway 24 crossing location. This location is upstream of the Gopher Creek confluence with the Assiniboine River. Mean monthly flows, including minimum and maximum flows, for the Assiniboine River near Miniota are provided in Table 4.5 below <sup>(14)</sup>.

**Table 4-5**  
**Monthly Mean Discharge (m<sup>3</sup>/s) - Assiniboine River Near Miniota (05ME006) 1961 to 2011**

Year	Jan	Feb	Mar	Apr	May	Jun	Jul	Aug	Sep	Oct	Nov	Dec
Mean	15.4	14.5	18.7	68.5	70.3	46.3	34.7	20.2	14.7	15.7	18.2	16.3
Minimum	6.11	5.63	1.75	7.95	3.75	3.03	1.36	0.496	0.854	1.87	5.91	5.37
Maximum	30.9	30.0	65.1	248	633	402	251	116	102	121	34.9	32.0

#### 4.1.4.1 Surface Water Quality

The State of the Watershed report <sup>(10)</sup> for the Arrow-Oak River Watershed notes that samples collected from Gopher Creek between 1978 and 1983, and between 1997 and 2006, generally met the guideline levels in the Manitoba Water Quality Standards, Objectives and Guidelines in place at the time of the report (2008). Pesticides were rarely detected in the watershed, but were always within provincial guidelines. With the exception of iron and manganese, the concentrations of all metals were within the provincial guidelines.

The report noted *E.coli* concentrations in Gopher Creek downstream of the Virden WWTP exceeded the provincial guidelines on a number of occasions. Some of the increased *E.coli* was attributed to discharge from the existing Virden WWTP, which was located about 600 m upstream of the sampling location. The concentrations of phosphorus and nitrogen at the Gopher Creek sampling location, as well as near the confluence with the Assiniboine River, were also noted to be elevated in comparison with upstream sampling locations on Gopher Creek. Conductivity, dissolved oxygen and total suspended solids at the downstream Gopher Creek sites were also noted to be likely affected by discharge from the Virden WWTP. Within the watershed, Gopher Creek was identified to have the highest nitrogen and phosphorus levels, and was recommended for targeting nutrient reduction programs to improve water quality.

Conductivity in Gopher Creek was reported to frequently exceed the water quality objective for irrigation (1,000 µS/cm). Low dissolved oxygen concentrations were often measured in Gopher Creek, at levels below the provincial objective of 5 mg/L, at concentrations that could cause fish kills and cause foul smelling water. Total suspended solids concentrations in Gopher Creek were within the provincial guidelines.

Sampling data that is representative of the current treatment process at the Virден WWTP, and resultant water quality in Gopher Creek and the Assiniboine River, was collected by the Town of Virден in May 2012<sup>(15)</sup>. The Town collected water quality samples in Gopher Creek at PR 257, about 2.3 km upstream of the effluent discharge, at the end-of-pipe discharge into the effluent drainage channel, in Gopher Creek immediately downstream of the outfall (in the mixing zone), in Gopher Creek about 600 m downstream of the outfall at the Trans-Canada Highway and in Gopher Creek downstream of the outfall at Welch's, about 11.5 km downstream of the outfall. The Town also collected two samples from the Assiniboine River, one about 5.6 km upstream of the confluence with Gopher Creek at the Thompson Bridge on PR 259, and one about 7.6 km downstream of the Gopher Creek confluence at the PR 257 bridge crossing. The sampling locations are shown on Plate 4-6 below.



*Plate 4-6: Surface water quality sampling locations for existing Virден WWTP effluent discharge.*

A set of four samples were collected, on May 9, 14, 16 and 18, 2012. The results are summarized in Table 4-6 below.

**Table 4-6**  
**Surface Water Quality Upstream and Downstream of Virden WWTP Effluent Discharge**

Parameter	Sample Date (yyyy/mm/dd)	Gopher Creek at PR 257 (2.3 km U/S of Outfall)	End-of-Pipe Effluent	Gopher Creek in Mixing Zone D/S of Outfall	Gopher Creek at Trans-Canada (0.6 km D/S of Outfall)	Gopher Creek at Welch's (11.5 km D/S of Outfall)	Assiniboine River (5.6 km U/S of Gopher Creek at PR 259)	Assiniboine River (7.6 km D/S of Gopher Creek at PR 257)
pH (pH units)	2012-05-09	8.46	7.75	8.4	8.43	8.52	8.46	8.44
	2012-05-14	--	--	--	--	--	--	--
	2012-05-16	--	--	--	--	--	--	--
	2012-05-18	--	--	--	--	--	--	--
Total Suspended Solids (mg/L)	2012-05-09	10	98	13	10	15	350	320
	2012-05-14	7	122	17	13	11	298	278
	2012-05-16	7	103	14	9	17	280	312
	2012-05-18	10	136	17	6	15	248	242
Ammonia (mg/L)	2012-05-09	0.025	16.4	1.88	0.483	0.032	0.059	0.046
	2012-05-14	0.038	27.6	2.11	0.78	0.028	0.05	0.041
	2012-05-16	0.022	27.1	2.35	0.49	0.028	0.031	0.029
	2012-05-18	0.045	30.1	2.37	0.89	0.051	0.061	0.042
Biological Oxygen Demand (mg/L)	2012-05-09	< 6.0	32.8	7.8	< 6.0	< 6.0	< 6.0	< 6.0
	2012-05-14	< 6.0	133	7.2	< 6.0	< 6.0	< 6.0	< 6.0
	2012-05-16	< 6.0	104	9.6	< 6.0	< 6.0	< 6.0	< 6.0
	2012-05-18	< 6.0	375	10.2	< 6.0	< 6.0	< 6.0	< 6.0

Parameter	Sample Date (yyyy/mm/dd)	Gopher Creek at PR 257 (2.3 km U/S of Outfall)	End-of-Pipe Effluent	Gopher Creek in Mixing Zone D/S of Outfall	Gopher Creek at Trans-Canada (0.6 km D/S of Outfall)	Gopher Creek at Welch's (11.5 km D/S of Outfall)	Assiniboine River (5.6 km U/S of Gopher Creek at PR 259)	Assiniboine River (7.6 km D/S of Gopher Creek at PR 257)
<i>E. Coli</i> (MPN/100 mL)	2012-05-09	15	> 110,000	110,000	9,300	230	23	15
	2012-05-14	23	> 110,000	> 110,000	24,000	9	23	< 3
	2012-05-16	43	> 110,000	110,000	46,000	23	< 3	7
	2012-05-18	15	> 110,000	110,000	24,000	4	9	15
Fecal Coliforms (MPN/100 mL)	2012-05-09	15	> 110,000	110,000	24,000	230	23	15
	2012-05-14	23	> 110,000	> 110,000	24,000	43	23	< 3
	2012-05-16	43	> 110,000	110,000	46,000	23	< 3	7
	2012-05-18	15	> 110,000	> 110,000	46,000	23	23	15
Total Coliforms (MPN/100 mL)	2012-05-09	75	> 110,000	> 110,000	> 110,000	430	43	73
	2012-05-14	930	> 110,000	> 110,000	110,000	150	230	93
	2012-05-16	230	> 110,000	> 110,000	110,000	430	230	43
	2012-05-18	230	> 110,000	> 110,000	46,000	93	230	930
Biological Oxygen Demand (mg/L)	2012-05-09	< 6.0	32.8	7.8	< 6.0	< 6.0	< 6.0	< 6.0
	2012-05-14	< 6.0	133	7.2	< 6.0	< 6.0	< 6.0	< 6.0
	2012-05-16	< 6.0	104	9.6	< 6.0	< 6.0	< 6.0	< 6.0
	2012-05-18	< 6.0	375	10.2	< 6.0	< 6.0	< 6.0	< 6.0



The microbiological parameter results upstream of the treated effluent discharge in Gopher Creek ranged between 15 and 43 MPN/100 mL for *E.coli* and fecal coliforms, and between 75 and 930 MPN/100 mL total coliforms. These results indicate that there are upstream sources of bacteriological contamination that are affecting Gopher Creek. The source of the bacteriological contamination is likely agricultural land use. The end-of-pipe results indicate that the current Virден WWTP discharge is adding greater than 110,000 MPN/100 mL of *E.coli*, fecal coliforms and total coliforms to the effluent drainage channel and then to Gopher Creek at the outfall location. The results drop by more than 50% by the time Gopher Creek reaches the Trans-Canada Highway, about 600 m downstream of the outfall location. At the next downstream sampling location, the bacteriological parameters have generally returned to near upstream (background) levels.

The pH result in Gopher Creek upstream of the discharge was 8.46. The end-of-pipe treated effluent discharge has a pH of 7.75. However, the Gopher Creek pH in the mixing zone returned to upstream levels, at 8.40 and remained constant at the downstream sampling locations.

The total suspended solids (TSS) results upstream of the discharge were low, between 7 and 10 mg/L. The end-of-pipe treated effluent discharge ranged from 98 to 136 mg/L, about 13.5 times the background concentration. However, the TSS results returned to background levels in the Gopher Creek mixing zone and remained relatively stable for the remaining downstream sampling locations. The TSS concentrations in the Assiniboine River were much higher than in Gopher Creek, ranging between 248 and 350 mg/L upstream of Gopher Creek, and 242 and 320 mg/L downstream of Gopher Creek.

Biological oxygen demand (BOD) upstream of the discharge in Gopher Creek was less than 6.0 mg/L. The end-of-pipe treated effluent discharge has a BOD ranging between 32.8 and 375 mg/L. Slightly elevated BOD results were observed in the Gopher Creek mixing zone, ranging between 7.2 and 10.2 mg/L, and then the BOD concentration returned to background levels at the remaining two downstream sampling locations, at less than 6.0 mg/L. The results in the Assiniboine River, both upstream and downstream of Gopher Creek, were also less than 6.0 mg/L.

Ammonia concentrations in Gopher Creek upstream of the discharge ranged from 0.022 to 0.045 mg/L. The end-of-pipe treated effluent discharge ammonia concentrations ranged from 16.4 to 30.1 mg/L (about 775 times higher than background conditions). The ammonia results were still moderately elevated in Gopher Creek within the mixing zone, ranging between 1.88 and 2.37 mg/L. About 600 m downstream in Gopher Creek, at the Trans-Canada Highway, the ammonia results were slightly elevated, ranging between 0.48 and 0.89 mg/L. The ammonia results returned to background concentrations at the final downstream sampling location. The ammonia results in the Assiniboine River were similar to the background Gopher Creek results, with slightly lower concentrations reported at the downstream location.

#### 4.1.4.2 Surface Water Allocation

Stream water (or aquifer) budgets have not been established for the Arrow-Oak watershed, therefore, the total amount of water available for allocation has not been determined. The State of the Watershed <sup>(10)</sup> report indicated 19 surface water projects were on file with the Water Licensing Branch, six of which were

for livestock watering, twelve for irrigation and one for a municipal supply. As of 2008, a total of 591.6 acre-feet of surface water had been allocated through licensing.

#### **4.1.4.3 Hydrogeology and Groundwater**

Groundwater quality in the Virден area varies significantly, with total dissolved solids concentrations reported from 388 mg/L along Gopher Creek near Virден to 848 mg/L west of Virден to 1,038 mg/L along Gopher Creek near the Assiniboine River <sup>(7)</sup>.

Potable groundwater quality in the project area ranges from very poor to good <sup>(16)</sup>. Salty water is common in the shale bedrock that underlies the area. The most common aquifers are lenses and pockets of sand and gravel within the surficial deposits. These shallow aquifers could be polluted by infiltration of pollutants from the surface, and consequently, the area is classified as a groundwater pollution hazard area. The yield of most of these aquifers is in the 0.1 to 1.0 L/s range. The underlying shale bedrock, which is generally more than 30 m below ground, usually yields only salty water. The Town of Virден obtains drinking water from two groundwater wells.

A buried bedrock valley is present northeast of Virден and the depth to shale in the buried valley may be more than 130 m at some locations. Relatively extensive and thick sand and gravel aquifers may occur in the buried valley.

A search of the Manitoba Water Well Drillers records <sup>(17)</sup> indicated a total of fifty-five (55) groundwater wells in the Virден area and adjacent downstream sections (see Plate 4-7) containing Gopher Creek and the Assiniboine River. The water well records from these eight sections are included in Appendix E.

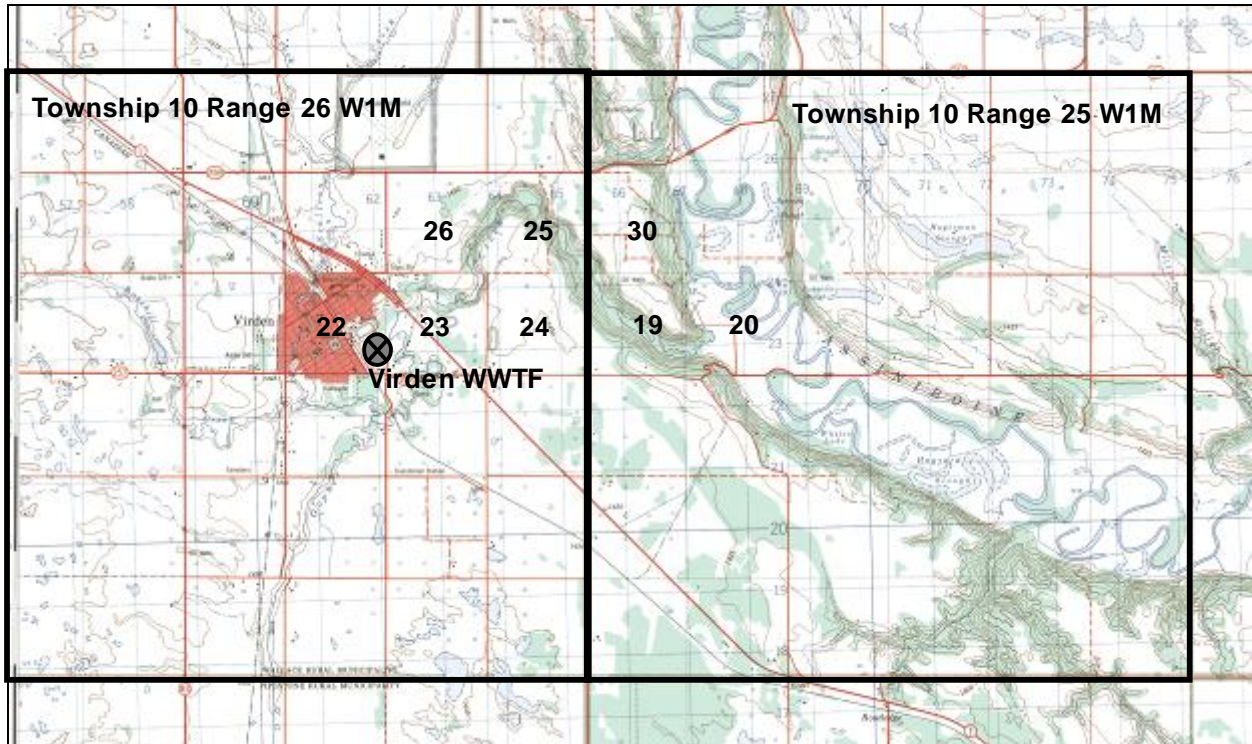

Plate 4-7: Location of water well records search near Virden WWTF.

**Table 4-7  
 Groundwater Wells and Use**

Section-Township-Range	Number of Wells	Domestic	Municipal	Industrial	Livestock	Irrigation	Test / Observation
22-10-26 W1M	25	17	1	1	0	0	6
23-10-26 W1M	12	4	0	1	(2)	4	3
24-10-26 W1M	4	1	0	0	2 (1)	0	1
25-10-26 W1M	1	1	0	0	0	0	0
26-10-26 W1M	3	0	0	0	0	0	3
19-10-25 W1M	3	1	0	0	0	0	2
20-10-25 W1M	6	0	0	0	0	0	6
30-10-25 W1m	1	0	0	0	0	0	1
<b>Total</b>	<b>55</b>	<b>24</b>	<b>1</b>	<b>2</b>	<b>2 (3)</b>	<b>4</b>	<b>22</b>

**Note:** Some wells are listed as domestic / livestock, these are shown as domestic wells with the well also shown in the livestock column in parenthesis.

The water well records for 22-10-26 W1M show domestic well depths ranging from 6.1 to 44.2 m below ground; however, the majority were drilled between 7.6 and 12.2 m below ground. Static water levels ranged from 1.5 to 8.5 m below ground, with the majority between 3.0 and 6.0 m below ground. Pump

testing, when conducted, ranged from 0.15 to 4.3 L/s, with most domestic wells tested at pumping rates below 0.75 L/s. Several industrial and/or municipal wells were drilled deeper, and encountered shale at depths ranging from 16.8 to 27.4 m below ground. Solid rock was noted in one test hole at a depth of 62.8 m below ground. One industrial well was test pumped at 13.3 L/s. The soil stratigraphy noted on the well records generally indicate layers of sand and clay until clay till is reached. Typically, the shallow wells are cased in the coarse soil units below the first or second clay layer, to protect against surface infiltration.

There are fewer well records for the adjacent 23-10-26 W1M, with only two domestic wells, and two domestic/livestock wells reported. Three of these four wells were drilled between 7.6 and 9.0 m below ground, and one was drilled deeper, at 32.0 m. Static water levels ranged from 2.0 to 7.9 m below ground, and test pumping rates were 0.30 to 3.8 L/s. Soil stratigraphy consisted of alternating layers of sand and clay in each hole. Four shallow irrigation wells were noted at the Virден Nursing Home, and were drilled to a depth of 4.9 m below ground and were test pumped at 0.76 L/s. The static water level in these wells was 2.7 m below ground.

Groundwater quality from the shallow sand and gravel aquifers typically exceeds several aesthetic drinking water parameters such as iron, manganese, total dissolved solids, sodium, sulphate and chloride. Most metal concentrations meet the drinking water guidelines, however, occasional exceedances for arsenic, lead, fluoride and selenium were noted, along with slightly more frequent exceedances for nitrate (as N). Total coliform bacteria are routinely detected in private well water in the watershed, indicating that pathways are likely present for contaminants to move from the surface or near surface into the groundwater. The watershed report (2008) indicated that 32% of samples from the shallow groundwater (46 of 144 samples) had detectable coliforms, but only 4% (6 of 153) of the samples had *E.coli* concentrations, indicating fecal contamination <sup>(10)</sup>.

## 4.2 TERRESTRIAL ENVIRONMENT

### 4.2.1 Vegetation

The project site is a developed industrial property that contains a landscaped grass frontage south of Third Avenue, along with a small row of trees near the boulevard. The remaining areas of the project site are free of vegetation and contain gravel access road and parking surfaces, and gravel surfaced storage areas.



*Photo 4-24: Vegetation along the north side of the Virден WWTF project site.*



*Photo 4-25: Vegetation on vacant lot east of the Virден WWTF project site.*

The project area surrounding the project site contains primarily aspen and oak vegetation, agricultural crop use and riparian vegetation along Gopher Creek. A vacant lot east of the Virден WWTF site contains a low area with standing water at the northwest corner. Forage crops are present in the lands on the east and west sides of Gopher Creek south of the Trans-Canada Highway. Further downstream along Gopher Creek, more intensive agricultural land use is observed.



*Photo 4-26: Typical riparian vegetation along Gopher Creek immediately downstream of the effluent drainage channel outlet.*



*Photo 4-27: Typical riparian vegetation north of TCH adjacent to agricultural areas.*



*Photo 4-28: Typical pattern of land use for forage crop production around stands of aspen and oak.*

The project area and project regional boundary downstream along Gopher Creek is rated by the Canada Land Inventory (CLI) Land Capability for Forestry classification system as CLI 6, which indicate severe limitations to the growth of commercial forests. Tree species indicators show trembling aspen and burr oak. CLI 5 is shown in the Assiniboine River valley, which also indicates severe limitations to the growth of commercial forests. Tree species shown are white elm and Manitoba maple. Plate 4-8 shows the CLI map for forestry.

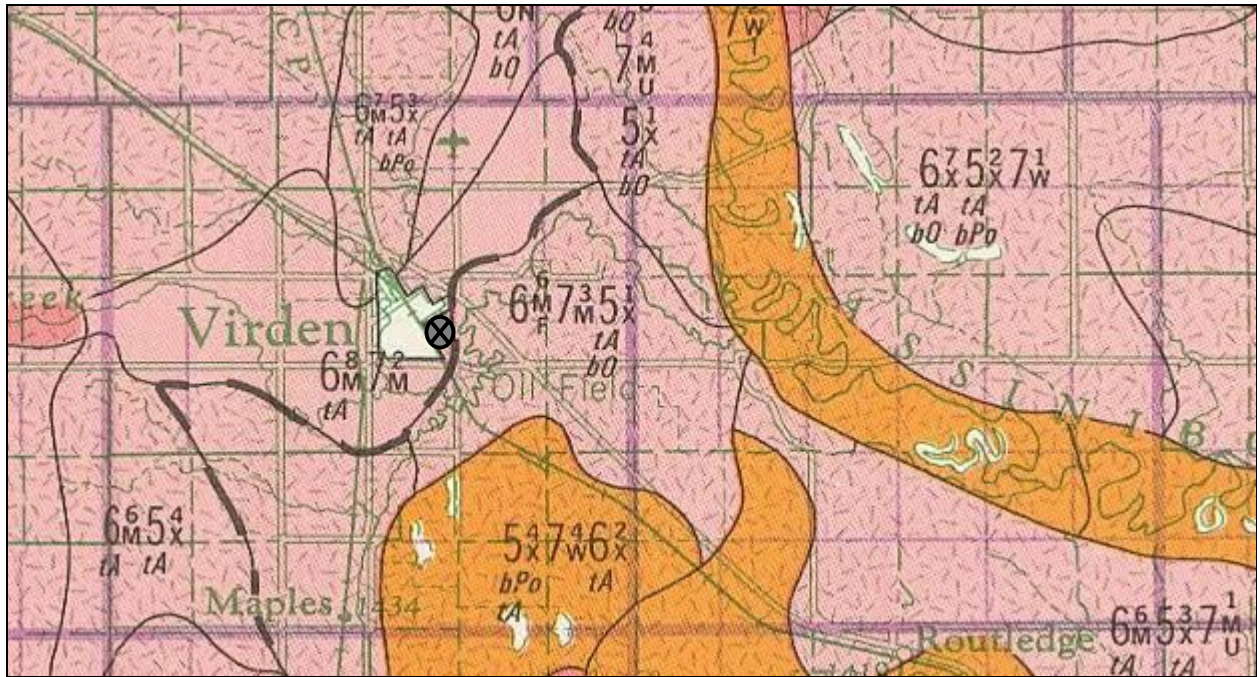

Plate 4-8: CLI Land Capability for Forestry in the Virден area.

#### 4.2.2 Wildlife

No wildlife species were observed on the project site, and the lack of vegetation suggests that wildlife would likely only be transient on the site. Natural land to the east, southeast and northeast of the site, including the Gopher Creek area, likely supports a variety of wildlife species. Nests were observed in several trees to the southeast of the project site near Gopher Creek.



Photos 4-29 and 4-30: Nests located 335 m southeast of the project site near Gopher Creek.

The project area and project regional boundary downstream along Gopher Creek is rated by the Canada Land Inventory (CLI) Land Capability for Waterfowl classification system as CLI 7, which has such severe limitations that almost no waterfowl are produced. Capability on these lands is negligible or non-existent. The subclass T is shown, indicating adverse topography due to steepness or flatness that limits the

development or permanence of wetlands. The agricultural land north and west of Gopher Creek is CLI 5, which includes lands with moderately severe limitations to waterfowl production, with subclasses T and M, which indicates poor soil moisture capability. The land transitions to CLI 3 in the Assiniboine River valley, which has slight limitations to the production of waterfowl. Capability on these lands is moderately high, but production may be reduced because of occasional droughts. A subclass I indicates the land is subject to inundation and excessive water level fluctuation, which adversely affects the habitat or nesting success of waterfowl. Plate 4-9 shows the CLI map for waterfowl.

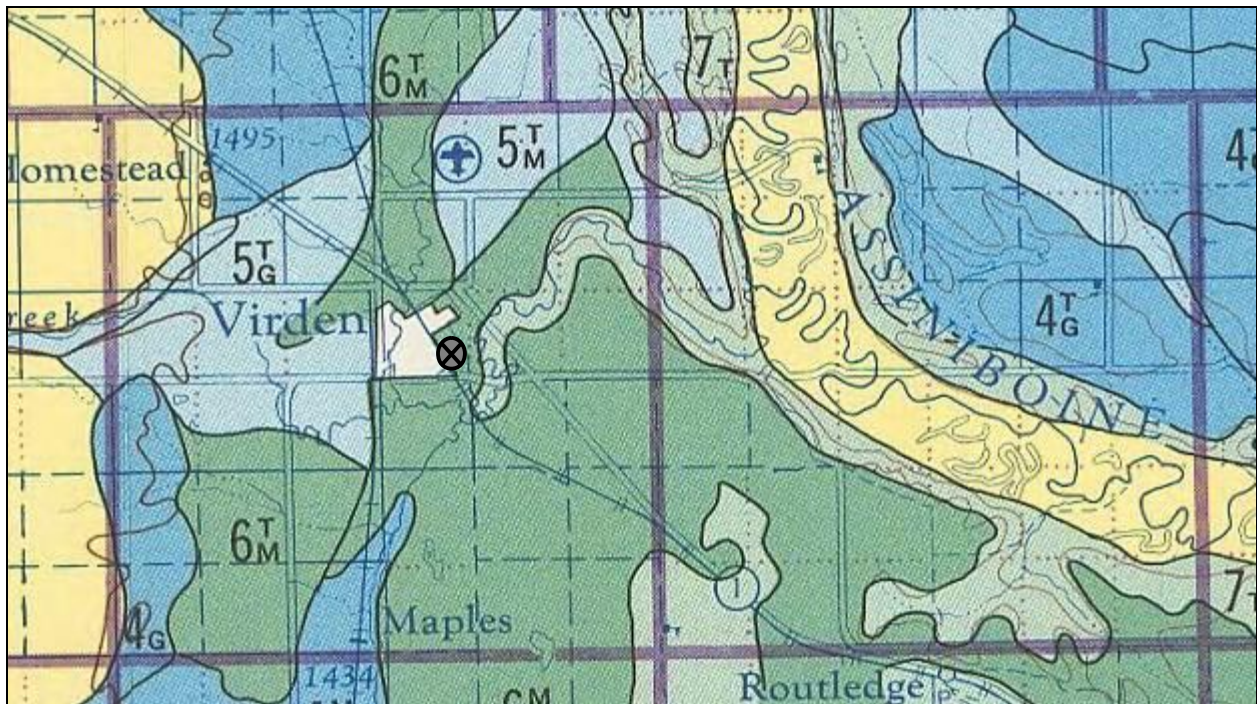

*Plate 4-9: CLI Land Capability for Waterfowl in the Virden area.*

The CLI Land Capability for Ungulates indicates the Gopher Creek area downstream of Virden is classified as CLI 3, indicating the land has slight limitations to the production of ungulates and the subclass letter "G" indicates there is poor distribution of landforms necessary for optimum ungulate habitat. The ungulate indicator species is listed as deer. The agricultural land west and north of Gopher Creek is CLI 5, indicating moderately severe limitations to the production of ungulates. Plate 4-10 shows the CLI map for ungulates.



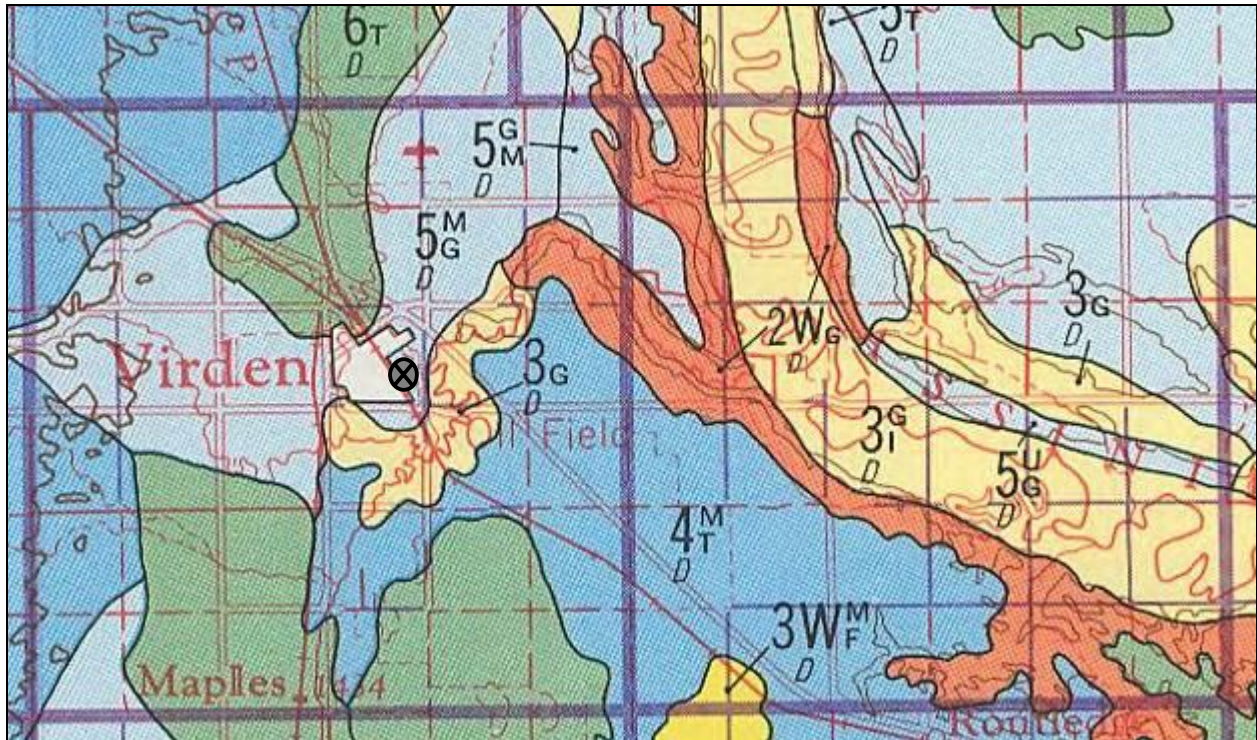

Plate 4-10: CLI Land Capability for Ungulates in the Virден area.

About one-half the distance along Gopher Creek downstream of the Virден WWTF, the land transitions to CLI 2W, a special category, indicating an area that is the winter range on which animals from surrounding lands depend. The same subclass is present with poor distribution of landforms, and the same indicator species is shown. Once in the Assiniboine River valley, the land transitions to CLI 3, indicating slight limitations to the production of ungulates, and subject to inundation which causes adverse effects to the habitat and survival of ungulates.

White-tailed deer are the most common native wildlife species in the watershed area and white elk and moose also commonly utilize parts of the watershed <sup>(10)</sup>. In general, the population of ungulates in the watershed is considered to be healthy, and supports both eco-tourism and hunting opportunities. Some black bear are present, and their population is also considered healthy and expanding in some areas. A variety of furbearers, such as beaver, muskrat, mink, coyote, red fox, timber woves, fisher and others can be found in the watershed <sup>(10)</sup>. Invasive or non-native species such as leafy spurge, are a concern in the watershed.

Discussions with a landowner north of the Trans-Canada Highway, with property adjacent to Gopher Creek, provided anecdotal evidence of white-tailed deer and occasionally bear, although bears were mostly observed in the Assiniboine River valley. The landowner also indicated beaver activity was very common along Gopher Creek, and noted at least seven (7) beaver dams to the north and east of the property.

As noted previously, the project site, area and regional boundary are located in the Aspen Parkland Ecoregion of the Prairies ecozone. Some areas within the ecoregion do provide major breeding habitat for waterfowl, and there are also suitable habitat areas for white-tailed deer, coyote, snowshoe hare, cottontail, red fox, northern pocket gopher, Franklin's ground squirrel, and bird species such as sharp-tailed grouse and black-billed magpie. In excess of 200 bird species have been noted in the Ecoregion <sup>(10)</sup>.

#### 4.2.3 Protected Species

A search request was filed with the Manitoba Conservation Data Centre (CDC) for information relating to species of conservation concern. The term species of conservation concern includes species that are rare, disjunct or at risk throughout their range in Manitoba and in need of further research. The term also includes species that are listed under the Manitoba Endangered Species Act (MBESA) or that have a special designation by the Committee on the Status of Endangered Wildlife in Canada (COSEWIC). The search request included the project site, project area, and the project regional boundaries that included land sections that contain Gopher Creek downstream from the project site to the Assiniboine River, and downstream in the Assiniboine River valley.

The response from the Manitoba CDC is included in Appendix F. Only one species occurrence was noted in the database, and was located in the northwest quarter section of 19-10-25 W1M, which is located three sections east of the Virден WWTF project area in the Assiniboine River valley. The occurrence was for the Great-blue heron (*Ardea Herodias*), and relates to a rookery observed at this location. The occurrence was ranked as S4S5. The "S#S#" designation means that there is a range of uncertainty about the exact rarity of the species on a provincial scale, between widespread (S4) and demonstrably widespread (S5). The S4 ranking defines the species as widespread, abundant and secure throughout its range or in the province, with many occurrences, but the element is of long term concern (> 100 occurrences). The S5 ranking defines the species as demonstrably widespread, abundant and secure throughout its range or in the province, and essentially impossible to eradicate under present conditions.

The Great-blue heron is not listed in Schedules 1, 2 or 3 of the federal Species at Risk Act (SARA). The fannini subspecies (Pacific Great Blue Heron) is listed in Schedule 3 of SARA, however, the range of this species is limited to British Columbia.

Within the watershed, the Manitoba CDC has recorded seventy-six (76) occurrences where species at risk have been observed (as of 2008 SOW report). Thirty-five (35) of the occurrences, totalling twenty-three (23) species were plants, thirty-eight (38) records (seven species) were animals, two snake hibernacula and one native plant community. Animal species that have been sighted in the watershed include: Baird's Sparrow; Burrowing Owl; Sprague's Pipit; Ferruginous Hawk; Loggerhead Shrike; and Mule Deer. Plant species include: Dakota Skipper; Smooth Goosefoot; and Western Spiderwort. The majority of these occurrences have been located in the Routledge and Oak Lake sandhills area of the watershed. As noted above, only one species was noted within the project site, project area and relevant part of the regional area.

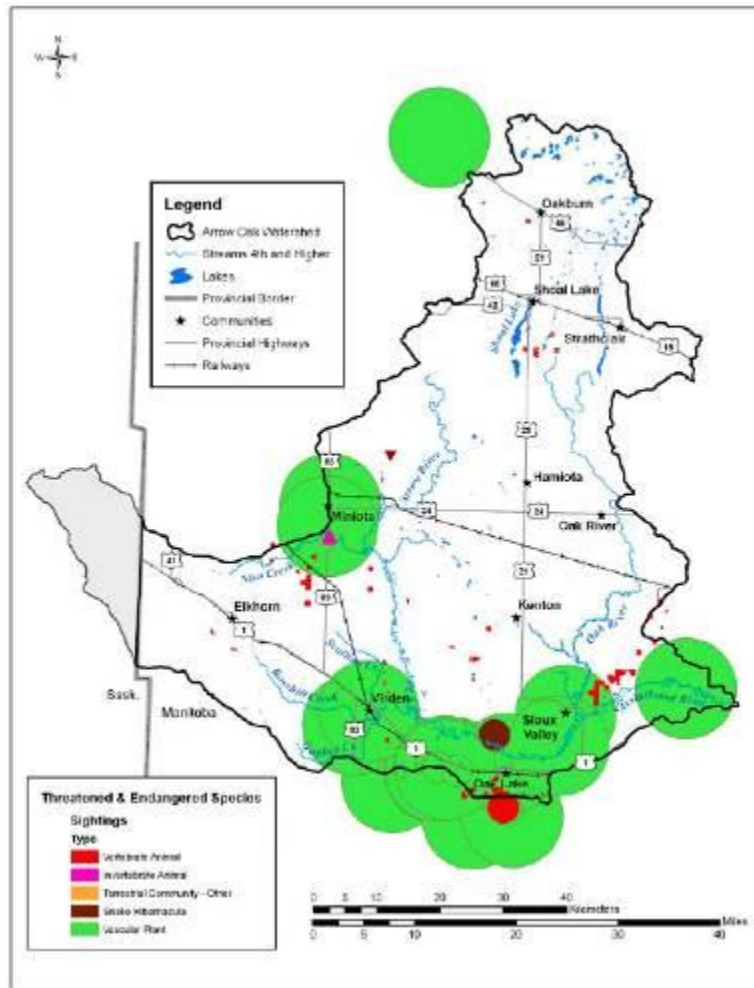

Plate 4-11: Distribution of threatened and endangered species in Arrow-Oak River Watershed

The full list of the species of concern occurrences within the Aspen Parkland ecoregion, as provided by Manitoba CDC, is included in Appendix F.

### 4.3 AQUATIC RESOURCES AND HABITAT

There are no aquatic resources or habitat within the project site.

The project area includes a surface drainage channel that is located on the north side of Third Avenue across from the northwest corner of the project site. The drainage channel travels approximately 175 m in a generally northern direction before discharging into Gopher Creek. The channel drops in elevation from 434 m at the end-of-pipe to 429 m at Gopher Creek. The last few metres of the drainage channel drop sharply into Gopher Creek and prevent aquatic species from entering the channel under normal and low flow conditions.

Gopher Creek, from the discharge of the drainage channel, to the confluence with the Assiniboine River, drops from an elevation of 428 m to 367 m over a distance of 13 km. Gopher Creek is not believed to support a large or diverse aquatic resource. Anecdotal evidence provided by a landowner, with property adjacent to Gopher Creek, downstream of the project site indicates that there are no recreational fish species in the creek, but that historically, some attempts were made to stock the creek with jackfish, pickerel and trout species. The landowner noted that the stretch of Gopher Creek downstream of the Virден WWTF can experience very low flow, but does not dry up as portions are spring fed and that the effluent discharge from the Virден WWTP provides a base flow condition.

Observations of Gopher Creek north of the Trans-Canada Highway show a creek crossing established by the placement of large cobbles and boulders. Aerial photography also shows another crossing had been constructed in SW 26-10-26 W1M; however, more recent photographs appear to show the crossing has been removed. These structures, and similar structures established by other landowners adjacent to Gopher Creek, may impede movement of fish during normal and low flow conditions.



*Plate 4-12: Gopher Creek crossing located in SW 26-10-26 W1M*

It is not known whether or how far species from the Assiniboine River travel upstream in Gopher Creek. Based on observations of Gopher Creek and Bosshill Creek well upstream of the Virден WWTF site (in mainly agricultural land use areas) and the creek discharge data, the creeks are likely intermittent most years to the south and west of the Town of Virден, and would not typically provide suitable aquatic habitat.

Within the Arrow-Oak River Watershed <sup>(10)</sup>, five COSEWIC listed fish species were known to be present: Lake Sturgeon; Maple Leaf Mussel; Silver Chub; Chestnut Lamprey; and Big Mouth Buffalo. Recreational fisheries were created by installing aeration systems on Shoal Lake (2), Kenton Reservoir and Patterson Lake. Numerous other water bodies are also stocked on a regular basis with indigenous fish species or salmonoids.

The CLI Watershed Capability for Sport Fish map for the Virден area indicates the project site and project area is CLI 4 and has severe limitations to the production of sport fish. The Assiniboine River valley area is rated about 70% CLI 3, indicating a moderate limitation to production of sport fish, with special factors such as short shoreline compared to area, ion imbalance and/or lack of special physical features such as

spawning facilities. About 30% of the valley is rated CLI 4 with severe limitations to production of sport fish.



Plate 4-13: CLI Watershed Capability for Sport Fish in the Virden area.

#### 4.4 SOCIO-ECONOMIC ENVIRONMENT

Data from the 2011 census <sup>(18)</sup>, including the National Household Survey (NHS) <sup>(19)</sup>, indicated that the population of Virden was 3,114, an increase of 3.5% from the 2006 census. The median age was 42.7 years for the total population, with a median male age of 39.9 and female median age of 45.7. The largest single age group was 20 to 24 years, with 220 people. 83.1% of the population was aged 15 and over.

Of the total population in private households (3,000), 175 were immigrants, with 80 arriving between 2006 and 2011 and 60 arriving before 1971. Of the 175 immigrants, 95 were from Europe (65 from the United Kingdom and 15 from the Russian Federation) and 65 were from Asian (all 65 from the Philippines). There were 80 individuals identified as visible minorities, with 50 identified as Filipino.

Aboriginal identity was reported as 165 of the 3,000 total population in private households. There were 105 identified as Métis and 60 identified as First Nations, with 55 reporting a registered or treaty status. A total of 35 reported an aboriginal language spoken, which included 25 Ojibway.

Those that moved into the area in the past year totalled 395 of the 2,925 respondents, and those that had moved into the area in the previous five years totalled 1,085 of the 2,795 respondents.

Of the 3,000 total population in private households, 2,265 were identified as Christian, 720 reported no religious affiliation and 15 reported other religions.

In terms of education, 1,120 of the 2,430 respondents aged 15 years and over held a postsecondary certificate, diploma or degree and 740 held a high school diploma or equivalent, with 575 having no certificate, diploma or degree.

The labour force participation rate was 66.3% (74.3% for males and 59.5% for females). The sales and service occupation category had the highest number of participants, followed by the trades, transport and equipment operators category, and the business, finance and administration category. Manufacturing and utilities was the least populated category, followed by natural and applied sciences. The unemployment rate was 3.4%.

The total number of occupied private dwellings was 1,375, with 1,035 owned and 340 rented. A total of 50 of the dwellings were part of a condominium development. The median value of the dwellings was \$159,748 and the average value was \$178,660.

Of the population aged 15 and over, a total of 2,385 reported income in 2010 and 50 did not. The median income was \$30,888 and the average income was \$37,982. For males, the median income was \$40,140 and the average income was \$49,340. For females, the median income was \$22,050 and the average income was \$27,652. The median household income was \$54,694 and the average household income was \$65,871. The average family size was 2.8.

The Town of Virден has two elementary schools (Goulter School and Mary Montgomery School), one junior high (Virден Junior High School) and one high school (Virден Collegiate Institute). The Town is located in the Fort La Bosse School Division, which has their division office in Virден.

The Town of Virден is located within the Assiniboine Regional Health Authority (RHA), which has an annual operating budget in excess of \$100 million<sup>(20)</sup>. The Assiniboine RHA employs over 3,000 people and operates 20 acute care facilities, one transitional care unit, 28 long-term care facilities, and seven elderly persons housing units. A total of 64 physicians provide care in the Assiniboine RHA.

The Virден Health Centre provides medical services with 25 acute care beds and is staffed by five family physicians. The Health Center provides emergency services, diagnostic services, public and mental health services, as well as palliative care, occupational and physiotherapy services, dietician services, an in-house pharmacy and a seniors adult day program. There are two personal care homes in Virден, each with 50 long term beds. Each care home also offers respite care.

Data from the Town of Virден community profile<sup>(21)</sup> indicates that the largest business sectors in Virден are the construction, retail and service sectors. These three sectors make up 55% of the businesses in

Virден (130 of the 237 businesses). Secondary sectors include food, financial and legal, vehicle service, oil service and computer, which make up 30% of the businesses (70 of the 237).

#### **4.4.1 Land Use**

The Town of Virден is part of the Trans Canada West Planning District. According to the Town internet page, the planning district is undertaking a review of the development plan, which will be followed by each municipal corporation updating their individual zoning bylaws.

The project site is located in an industrial land use area and is surrounded by light and heavy industrial land use, as well as commercial land use. The nearest residential development is located about 340 m to the west-southwest, on the west side of the CPR tracks. Agricultural and natural land uses are found in the project area immediately north and east of the project site, and are predominant outside the Town of Virден boundaries. Oil extraction occurs on agricultural and natural lands, with pump jacks observed frequently to the south, east and north of the project site in the surrounding project area. The Virден Oilfield underlays the Town and contains three large pools: Virден; Daly; and Sinclair.

The CLI Land Capability for Recreation map for the Virден area indicates a CLI 6 class and a low capability for outdoor recreation, based on an absence of natural quality and significant features. CLI 6 lands can support low rates of recreational use on a dispersed basis. The lower reaches of Gopher Creek and the Assiniboine River valley are rated as CLI 4, indicating these lands have moderate capability for outdoor recreation. Subclass notations include areas exhibiting variety in topography or land and water relationships suitable for hiking, nature study and aesthetic appreciation; shoreland or upland areas suited to camping, and land providing access to water that provides opportunity for fishing and canoeing.

A small area north of Virден is classified as CLI 5, with subclasses indicating a major, permanent non-urban man-made structure of interest and a vantage point area. This is the Fort Montagne a la Bosse Monument located in the R.M. of Woodworth.

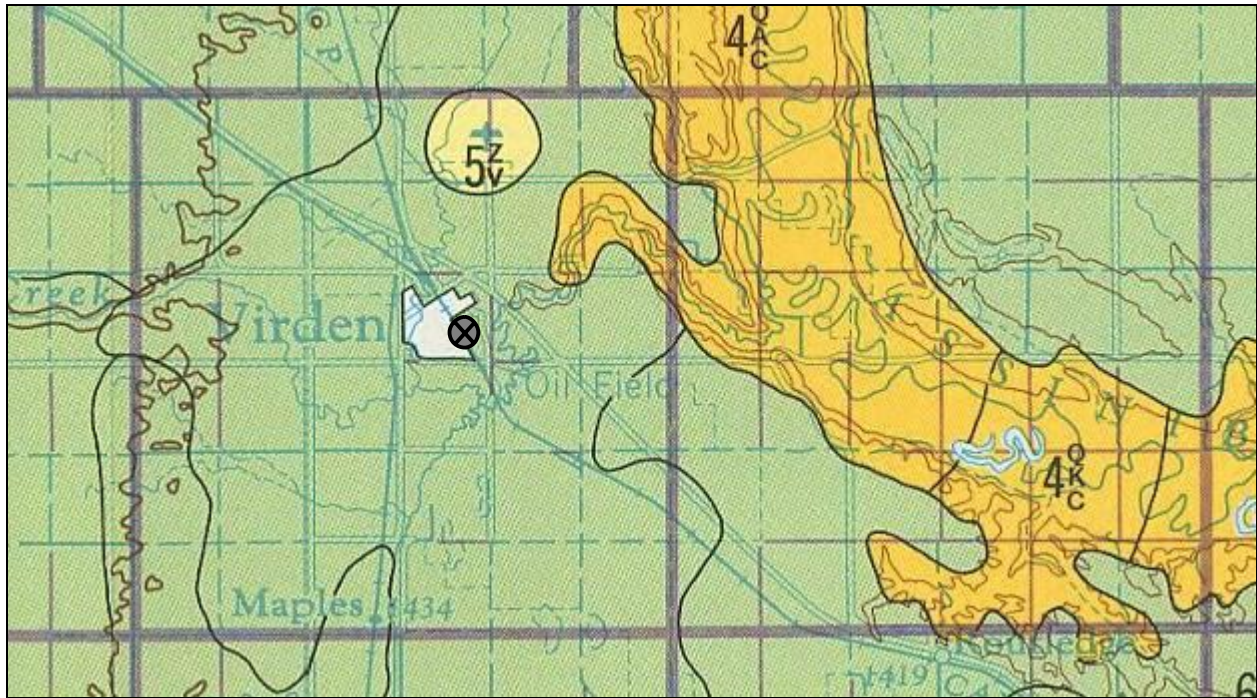

Plate 4-14: CLI Land Capability for Recreation in the Virden area.

#### 4.4.2 Transportation

The Trans-Canada Highway (TCH) is located along the north and east sides of the Town of Virden. The Trans-Canada Highway is the major east-west transportation route for all vehicular traffic and is rated as a Regional Transportation Advisory Committee (RTAC) Highway at 62,500 kg <sup>(22)</sup>. Provincial Trunk Highway 83 (PTH 83) is provincially designated in Schedule H of the Vehicle Weights and Dimensions on Classes of Highways Regulation (M.R. 575/88) as an A1 Highway (56,500 kg) and is located on the west side of the Town. PTH 83 is a major north-south transportation route that begins at the Canada-United States border and terminates at PTH 10 east of Swan River, Manitoba. PTH 83 joins US 83 at the border, which traverses the entire United States and terminates at Brownsville, Texas. Provincial Road 257 (PR 257), a B1 Highway (47,630 kg) is located along the south side of the Town, originating just east of Virden and terminating at the Saskatchewan-Manitoba border where it becomes Highway 48.

The Town of Virden street network is mainly oriented in a northwest-southeast grid pattern. The main commercial street is 7<sup>th</sup> Avenue South

The Canadian Pacific Railway main cross-Canada line passes through the center of the Town of Virden between 5<sup>th</sup> and 6<sup>th</sup> Avenue South, with a branch line originating at Virden, and leading to Rocanville, Saskatchewan and the Potash Corporation of Saskatchewan (PotashCorp) mine.

The Virden/R.J. (Bob) Andrew Field Regional Aerodrome is located about 3.5 km north of the Virden WWTP. The International Civil Aviation Organization (ICAO) code for the airport is CYVD. The airport is



operated by the Town and has a paved 1,220 m (4,000 ft) runway. The airport is located at the former Royal Canadian Air Force (RCAF) Station Virден, a World War II British Commonwealth Air Training Plan (BCATP) flying training station. The station was home to the No. 19 Elementary Flying Training School (19 EFTS) and included the use of de Havilland Tiger Moth and Fairchild Cornell airplanes<sup>(23)</sup>. The training station opened May 16, 1941 and closed December 15, 1944<sup>(24)</sup>.

Two other airports with Transport Canada Location Identifiers (TC LID) are located near Virден. The Virден (Gabrielle Farm) Airport (TC LID CKR7) is located about 7.3 km southwest of the Virден WWTP in the R.M. of Pipestone and the Virден (West) Airport (TC LID CJZ5) was located 11.3 km northwest of Virден in the R.M. of Wallace. The nearest regional airport is the Brandon Municipal Airport (YBR) located in Brandon, Manitoba.

#### 4.5 HERITAGE AND CULTURAL RESOURCES

The project site is a previously developed industrial lot within the Town of Virден. Heritage and cultural resources are not known to occur at the project site.

The Manitoba Historical Society<sup>(25)</sup> publishes an interactive map that identifies historic site locations. The map lists the following sites in Virден and the surrounding area:

- Virден War Memorial (Victoria Park);
- Queen Terrace (302 Queen Street West), built in 1890, a rare example of row housing in rural Manitoba;
- St. Mary the Virgin Anglican Church (Ninth Avenue South), built in 1892;
- Virден Municipal Building and Auditorium (Wellington Street), built in 1911-12, one of the finest and best equipped opera houses in western Canada;
- Canadian Pacific Railway Station, built in 1900, the only station in Manitoba constructed of fieldstone;
- Canadian Pacific Railway Underpass (6<sup>th</sup> Avenue South), built in 1917, to allow pedestrians to cross the tracks safely;
- Alexandra Hotel (6<sup>th</sup> Avenue South and Nelson Street), built in 1907;
- McDonald Drug Store and Bakery (237 Nelson Street West), built in 1893 in Romanesque Revival style and a municipally designated historic site;
- Scott Block/Old Post Office (Nelson Street West), built in 1914;
- St. Paul's United Church (Nelson Street West), built in 1901;
- Empire Publishing Building, built in 1905;
- Virден Pioneer Home Museum (390 King Street), built in 1888, a Victorian style brick-veneer home;
- Discovery Well Cairn (King Street), erected in 1955 to commemorate the Discovery Well in the Manitoba oil fields;
- Virден Consolidated School No. 144, built in 1905;
- Virден Concrete Bridge (PR 257), built in 1924;

- Commonwealth Air Training Hangar (Virден Airport), used during World War II as a training facility for pilots;
- Virден Cemetery
- Fort Montagne a la Bosse Monument (RM of Woodworth), marks the approximate location of Fort Montagne a la Bosse, North West Company trading post established about 1790 overlooking the Assiniboine River valley east of Virден, and destroyed during gravel extraction for construction of the CPR;
- Wallace Concrete Bridge, likely constructed in the early 1920's;
- Stone Granary
- Wallace Timber Bridge

Various early aboriginal archaeological sites are found in western Manitoba, particularly along the Assiniboine River valley and in the Oak Lake aquifer region. The area was good for hunting, with large buffalo herds grazing on the surrounding plains area on both sides of the Assiniboine River. European settlement was established in the area around 1790, with the construction of Fort Montagne a La Bosse by the North West Company. It was primarily a pemmican fort supplying food for the Red River settlement, and for further expansion of the fur trade to the north and west. The Canadian Pacific Railway reached Virден in 1872 and the first town site was established near Gopher Creek, east of the present Town <sup>(21)</sup>.

#### **4.6 FIRST NATIONS**

Three First Nations are located near Virден: Canupawakpa Dakota First Nation; Birdtail Sioux and Sioux Valley Dakota Nation. In Manitoba, there are seven Treaties with First Nations (1, 2, 3, 4, 5, 6, and 10); however, none of the three First Nations near Virден are signatory to any Treaty with Canada <sup>(26)</sup>. Summary information on the three First Nations below was obtained from the First Nations Profiles published by AANDC <sup>(27)</sup> Plate 4-15 shows the location of the three First Nations near Virден.



*Plate 4-10: Location of First Nations near the Virden WWTF project site.*

The Canupawakpa Dakota First Nation (No. 289) has a total registered population (in September 2013) of 668, with 318 located on the reserve. The main reserve (No. 06407) contains 1,023.9 ha of land and there are two smaller reserve areas: Oak Lake 59A (No. 06408), located in the southwest quarter of Section 34, Township 8, Range 26, WPM and containing 65 ha; and Fishing Station 62A (No. 06400), located in the northeast quarter of Section 23, Township 20, Range 24, WPM, and containing 65 ha. The Birdtail Sioux and Sioux Valley Dakota First Nations are also present at the Fishing Station 62A location. The election system for the First Nation is based on the Indian Act electoral system.

According to the latest Status Report on Specific Claims, Canupawakpa Dakota First Nation has a closed file for a claim on the alleged wrongful 1909 surrender of Turtle Mountain Reserve No. 60. The legal opinion was signed in 1994 and claim was not accepted for negotiations in 2001. The file was closed in 2007.

The Sioux Valley Dakota First Nation (No. 290) has a total registered population (in September 2013) of 2,472, with 1,390 located on the reserve. The main reserve (No. 06409) contains 4,136.0 ha of land and there is one smaller reserve, Fishing Station 62A, that is shared between the three local First Nations. The electoral system for the First Nation is a custom electoral system.

The Sioux Valley Dakota First Nation have a claim on the alleged unlawful alienation of wood lot reserve land. The legal opinion of no lawful obligation was signed in 1995 and the claim was not accepted for negotiations in 1999. The file has not been closed.

The Birdtail Sioux (No. 284) has a total registered population of 825, with 431 located on the reserve. The main reserve (Birdtail Creek 57, No. 06398) contains 2,735.7 ha of land and there are two smaller reserve areas: Birdtail Hay Lands 57A (No. 06399) located 9 km northwest of Miniota and containing 119.8 ha; and Fishing Station 62A. Birdtail Sioux are affiliated with the Dakota Ojibway Tribal Council.

The Birdtail Sioux have a claim on the unlawful taking of a portion of Indian Reserve 57 for a railway without surrender. The claim was filed in 2009 and the legal opinion of no lawful obligation was signed in 2011. The claim was not accepted for negotiations in 2012, but the file has not been closed.

## **5.0 ENVIRONMENTAL EFFECTS AND MITIGATION**

### **5.1 INTRODUCTION**

Environmental effects include changes that the project may cause to the environment. For the purposes of this assessment, environmental effects were identified from interactions between the proposed project activities and the environmental components. Mitigation measures to reduce and/or eliminate potential environmental effects that are adverse have been identified.

An underlying assumption to this assessment is that the Project will be constructed with due care for safety and environmental matters, using current and reasonable construction practices, and following existing health, safety and environmental legislation.

### **5.2 PHYSICAL ENVIRONMENT**

#### **5.2.1 Air Quality**

##### **5.2.1.1 Construction**

There is a potential for air quality impacts during construction from dust raised by construction equipment and gaseous and particulate emissions from this equipment. It is expected that there will be less than twenty (20) emission sources (construction vehicles and equipment) operating at any one time at the project site during construction of Phase I and Phase II of the project. Vehicle and equipment exhaust emissions are expected to result in a potentially minor decrease in air quality at the project site and the immediately surrounding project area and a negligible impact in the regional area. The potential effect at the project site/area is small and short-term, for the duration of the construction activities, during working hours.

Potential airborne dust and particulates during construction resulting from vehicle movement, earthworks and demolition activities has the potential to cause minor effects to air quality, human health and vegetation (from dust deposition). As with exhaust emissions, these potential effects are limited to the project site and immediate project area and are small and short-term.

Potential odorous emissions during construction relate to paint, asphalt, adhesives and solvent use, as well as activities that may release wastewater odours during retrofitting. The project site is located in an industrial area, with the nearest residential development located about 340 m southeast of the property. It is expected that with this buffer zone to the nearest residential area, odours generating from construction will be negligible.

##### **5.2.1.2 Operation**

During the operation of the Virден WWTF, traffic to and from the site will occur to provide material deliveries, dispose of screenings, remove biosolids and deliver septage. During Phase I operation, a

decrease in traffic is anticipated as the septage facility will not be operational and truck hauling will cease until Phase II is complete. After Phase II construction, truck hauling of septage will resume and is expected to start at a level similar to that which exists at the current facility, followed by a gradual increase in deliveries as R.M. of Wallace residents are added to the system. The septage facility has been sized to receive up to six (6) truck loads per day. Biosolids removal will add another three trucks per week. The potential effect of traffic emissions during Phase I operation is expected to be negligible and during Phase II operation is small, limited to the project site and immediately surrounding project area, and long-term.

Based on the traffic pattern described above, fugitive airborne dust and particulates from vehicle movement during operation is expected to be negligible during Phase I and small, localized to the project site/immediate project area and long-term during Phase II operation. Mitigation measures have been included to address dust generation from vehicle movement.

The two areas of the facility where significant odour will be generated are the Headworks and the solids dewatering areas. These areas will be enclosed buildings and so odour is not expected to become a public irritant. However, provision has been made to collect foul air from both of these buildings in case odour control is required in the future. Initial build-out of the facility will include ducts for collecting foul air. If odour is determined to be an issue, the ducts can be routed to an earthen biological filter for treatment of the odour causing compounds. The biological filter would be composed of woodchips and other bulking agents to provide an environment that promotes microbial activity. Foul air would be passed through the bottom of the filter where microorganisms would oxidize the odour causing compounds before the air is passed through the top of the filter into the atmosphere. Experience with similar filters in Alberta and British Columbia indicates that these filters are effective throughout the winter months.

Biosolids will be continue to be disposed at the Virден waste disposal ground sludge dewatering cell, which is not located near potential receptors. The air quality impact from the disposal of biosolids is expected to be negligible.

Indoor air quality is a concern with wastewater treatment plants, particularly where hydrogen sulfide ( $H_2S$ ) may be present. In confined spaces,  $H_2S$  can be a serious inhalation hazard that can impact human health even at low levels, if exposure occurs over a prolonged period.  $H_2S$  is also corrosive to equipment and building materials such as concrete. The Headworks building will be classified as a hazardous location (due to explosive gases) as well as a corrosive location and a wet location. Equipment in this area will be rated for these conditions, and wiring will generally be TECK cable with explosion proof fittings. Sensors will be used to monitor levels of  $CH_4$  (methane) in hazardous locations, and levels of  $H_2S$  and  $O_2$  (oxygen) in locations where the atmosphere could become hazardous to operators. After implementation of these standard design mitigation measures, the indoor air quality effects are determined to be insignificant.

### 5.2.1.3 Mitigation Measures

The following mitigation measures are included to address potential air quality impacts from construction and operation of the Virден WWTF:

- Limit the height of material stockpiles and cover piles, as required;
- Limit the area of exposed soil and complete re-vegetation as soon as possible after exposure;
- Maintain all vehicles and air pollution control equipment in good working order.
- Use water spraying on granular surfaces as required to reduce dust generation; and
- Keep vehicle idling to a minimum to reduce gaseous and particulate emissions.

#### **5.2.1.4 Residual Effects after Mitigation**

Residual effects on project site air quality are expected during construction and operation. The residual effects, after implementation of mitigation measures, are expected to be small in magnitude, limited to the project site and immediately surrounding project area, and long-term in duration (construction and operation phases). As a result, the potential residual effect is determined to be not significant.

### **5.2.2 Noise**

#### **5.2.2.1 Construction**

Noise will be generated to varying degrees during construction and is associated with heavy truck traffic used to transport materials to the site, operation of equipment used for construction activities and related traffic associated with construction. The potential effect at the project site and immediately surrounding project area is expected to be moderate and short-term, for the duration of the construction activities, during working hours.

#### **5.2.2.2 Operation**

During operation, noise will be generated to varying degrees and is associated with the use of pumps and blowers, the backup generator and noise due to truck traffic to the site (septage hauling) and regular vehicle traffic (employees and visitors).

The noise emissions from pumps, blowers and other equipment at the site is expected to be negligible since this equipment will be located inside the proposed Headworks building (Phase I) and Blower/UV building (Phase II). Blowers will also include integral sound enclosures to reduce noise emissions. Workers will be exposed to noise inside the Headworks building and Blower/UV building during operation. All areas requiring hearing protection will be posted with warning signs.

Noise due to the backup generator is anticipated to be infrequent, as the generator is expected to only run for several hours each month. Given the buffer distance of 340 m to the nearest residential area, the potential noise impact from generator use is expected to be negligible.

Given the expected decrease in traffic during Phase I operation and small increase in traffic during Phase II operation, noise impacts from the traffic during operation are also expected to be negligible during Phase I and small, localized to the project site/immediate project area and long-term during Phase II operation.

### 5.2.2.3 Mitigation Measures

The following mitigation measures are included to address potential impacted related to noise:

- Keep vehicle idling to a minimum to reduce noise emissions;
- Maintain vehicles in good working order and ensure all noise dampening equipment is installed and operational; and
- Provide hearing protection for workers and post clear signage in all areas of the plant that require hearing protection to be worn.

### 5.2.2.4 Residual Effects after Mitigation

Residual effects related to noise are expected during construction and operation. The residual effects, after implementation of mitigation measures, are expected to be small in magnitude, limited to the project site and immediately surrounding project area, and long-term in duration (construction and operation phases). As a result, the potential residual effect is determined to be not significant.

## 5.2.3 Climate

### 5.2.3.1 Construction

During construction, greenhouse gas (GHG) emissions consisting of carbon dioxide and nitrous oxides will be produced by combustion engines, including staff vehicles, construction vehicles and construction equipment. GHGs can contribute to long-term negative climate change effects. It is difficult to measure climate change effectively on a small scale such as the project site/project area, therefore, the GHG emissions from the project are predicted relative to the generation of GHGs in Manitoba (regional area and beyond).

It is estimated that less than 20 total pieces of combustion-fired equipment will be in use at the site at any one time during construction, including those delivering supplies and materials. Although the total GHG emissions from these vehicles has not been defined, based on the number of pieces of equipment, the amount of GHGs emitted is expected to be negligible in comparison to the amount of GHGs emitted in the province as a whole. Data from 2011 indicate that Manitoba GHG emissions totalled 19.5 million tonnes of CO<sub>2</sub> equivalents <sup>(28)</sup>. At the project site, GHGs would be produced over the short-term (during construction) and continuously during working hours. The generation of GHGs from construction equipment is expected to negligibly contribute to long-term negative climate change effects.

### 5.2.3.2 Operation

Operation of wastewater treatment plants produce the GHGs: carbon dioxide; nitrogen oxide; and methane. Research presented by Monteith et. al. <sup>(29)</sup>, and based on sixteen (16) Canadian wastewater treatment facilities and extrapolated to all provinces, has shown that the principal GHG emitted from municipal wastewater treatment plants is carbon dioxide, with very little methane expected. The emission rate calculated for conventional activated sludge treatment, with anaerobic sludge digestion, was



0.245 kg CO<sub>2</sub> equivalent per m<sup>3</sup> of wastewater treated for Manitoba, which takes into account the hydroelectric generation of power in the province. When all wastewater processes are considered, the Manitoba GHG emission factor is 0.261 kg CO<sub>2</sub> equivalent per m<sup>3</sup> of wastewater treated. This more conservative value is used to estimate the GHG emissions from the Virден WWTF.

The expected average annual flow after commissioning (in 2016) the Virден WWTF is 1,148 m<sup>3</sup>/d, which corresponds to 109 tonnes CO<sub>2</sub> equivalents per year using the factor from Monteith et. al. The 2033 design flow is 1,350 m<sup>3</sup>/d, which corresponds to 128 tonnes CO<sub>2</sub> equivalents per year. These emission rates are negligible in the context of Manitoba's annual GHG emissions of 19,500,000 tonnes.

Disposal of the biosolids will also produce some GHG emissions during transportation of the solids and subsequent degradation of the solids off-site (in this case, at the Town of Virден landfill facility). The indirect GHG emissions arising from the degradation will depend on the eventual end use of the biosolids. If a reuse can be found (such as the sale of biosolids as a soil amendment), this may offset the use of other products that have GHG emissions. In any case, these emissions are considered to be negligible.

A search of Environmental Canada facility reporting for GHGs revealed no Manitoba wastewater treatment plants have reported GHG emissions (in 2011). Those facilities emitting more than 50,000 tonnes of GHGs are required to submit a report.

In addition to the operation of the Virден WWTF, vehicles transporting septage, and removing screenings and biosolids, will generate small quantities of GHGs. As discussed in the section above for construction, these emissions are considered negligible and have not been defined. Mitigation measures to reduce greenhouse gas emissions are provided below.

### **5.2.3.3 Mitigation Measures**

Although GHG emissions are considered to be negligible in the context of provincial emissions, the following mitigation measures are recommended to reduce the overall carbon footprint of the Virден WWTF project:

- Properly maintain vehicles and equipment used at the project site;
- Keep vehicle and equipment idling to a minimum;
- Explore opportunities to increase the effectiveness of biogas generation and utilization which will decrease the GHGs assigned to the facility; and
- Explore opportunities to reuse biosolids to replace other GHG emitting sources.

### **5.2.3.4 Residual Effects after Mitigation**

The amount of GHGs emitted during construction and operation of the Virден WWTF is expected to be negligible in comparison to the GHGs emitted by the province as a whole (less than 200 tonnes per year versus 19,500,000 tonnes per year). As a result, potential residual effects are not expected.

## **5.2.4 Geology**

### **5.2.4.1 Construction**

Construction activities are not anticipated to affect the geology of the project site, project area or regional area since the project activities will be generally limited to the surficial soil environment. Excavation of foundations for the proposed Headworks building and Blower/UV building are limited to about 2.5 m below grade. Excavations for utility connections and wastewater piping are also expected to be shallow. There is no requirement for any more than minor quantities of borrow material that could be sourced from aggregate sites that could negatively affect geologic landforms by permanent removal. Given these factors, the effect on geology from construction is expected to be negligible.

### **5.2.4.2 Operation**

The operational activities of the project are not anticipated to affect the project site, project area or regional area geology as these activities are generally limited to the surficial soil environment.

### **5.2.4.3 Mitigation Measures**

Since the impacts to geology from the project construction and operation are negligible, no mitigation measures are required.

### **5.2.4.4 Residual Effects after Mitigation**

The effect of the project construction, operation and decommissioning on geologic landforms is expected to be negligible. As a result, residual effects are not expected.

## **5.2.5 Soils**

### **5.2.5.1 Construction**

Site preparation works, including clearing and grading, will result in removal and changes to soil including possible loss due to erosion, mixing and compaction, and potential contamination as a result of accidents.

Conditions favourable to soil erosion can occur during clearing and grubbing, excavation work, stockpiling and equipment movement on-site. The project will disturb a small area no greater than 8,075 m<sup>2</sup> (95 x 85 m). Erosion of soil and material stockpiles due to wind can cause subsequent effects on air quality (dust and particulate matter), while erosion due to precipitation and runoff can cause subsequent effects on surface water quality and potentially on downstream fish habitat. Based on the existing site conditions, which include sandy soil, northerly and westerly flowing drainage channels, creeks and rivers, erosion has the potential to occur at the project site, with potential effects observed in the surrounding project area.

Soil compaction can occur from construction vehicle movement and placement of materials and stockpiles. Large changes in soil compaction can also subsequently change surface drainage patterns and affect vegetation growth. Based on the site-specific coarse soil conditions and disturbed nature of the site, there are negligible effects from the project construction on soil compaction.

Soil contamination can occur from fluid leaks on construction equipment, improper disposal of cleaning rags, used oil, solid waste and wastewater from portable sanitary facilities. Given the coarse grained soil texture at the project site, potential spills of hazardous materials can migrate both vertically and horizontally through the soil away from the project site. Additionally, during fresh concrete pours, concrete wash water and/or fresh concrete can be released and migrate through or across the soil into a waterway, where the pH can rise causing subsequent effects to surface water quality and fish and/or fish habitat.

#### **5.2.5.2 Operation**

The Virден WWTF will utilize a standby diesel generator, and various quantities of hazardous materials. Improper storage of these materials or spills, leaks or accidental releases, can negatively affect the quality of the soil at the project site and in the surrounding project area. Process failures, tankage failures, pipeline failures or other accidents, may release raw or partially treated wastewater to the environment and could affect soil quality at the project site and in the surrounding project area. It is assumed that proper engineering design of the processes and equipment at the Virден WWTF will mitigate the potential for spills, leaks and failures to a significant extent.

#### **5.2.5.3 Mitigation Measures**

Mitigation measures to reduce potential project effects on soil quality include:

- Prepare an erosion and sedimentation control plan for the project outlining practices that should be adopted during construction and decommissioning;
- Maintain a 30 m setback distance from waterways and do not clear vegetation within the setback distance;
- Stockpile topsoil and other organic soils separately for reuse;
- Limit material stockpile heights and cover, if required;
- Locate material stockpiles away from drainage areas;
- Keep disturbed/exposed areas to a minimum and re-vegetate as soon as practical, where required;
- Limit vehicle and equipment movement to access pathways within and around the work areas;
- Properly store all waste materials and remove from the site promptly;
- Collect and dispose of concrete and concrete wash water off-site or by surface infiltration at least 100 m away from a drainage feature to prevent migration to the surface water;
- Do not store fuel or oil products on site unless at least 100 m away from a drainage feature and contained within spill-proof enclosures;
- Maintain spill clean-up equipment on-site during construction, operation and decommissioning activities;

- Diesel aboveground storage tanks for standby generators to meet applicable provincial and federal legislation and codes of practice for containment (e.g. double-walled tanks);
- Chemical storage room to contain impermeable floor and berm to hold at least 110% of the volume of the largest storage container;
- Conduct regular inspection of all hazardous material storage containers for evidence of leaks; and
- Prepare an emergency response plan.

#### **5.2.5.4 Residual Effects after Mitigation**

With the implementation of applicable mitigation measures and engineering design standards, the potential residual effects to soil are anticipated to be small in magnitude, limited to the project area and long-term in duration. As a result, the potential residual effect is determined to be not significant.

### **5.2.6 Groundwater**

#### **5.2.6.1 Construction**

During construction, the shallow groundwater table may be encountered during excavation of the foundation for the Headworks building and the Blower/UV building. The previous geotechnical study indicated the water table elevation at about 2.0 m below ground surface. This high ground water poses some challenges with buried tankage. The Detailed Design of the structural foundation will likely require elevated tankage with a foundation base slab bearing on the soils above the ground water level. The current proposed hydraulic profile has the SBR tankage buried at 2.5 m, as opposed to 5.0 m, to avoid the high groundwater. As a result, the new Headworks building is an additional 2.5 m taller to accommodate the raised hydraulic profile.

Site drainage measures to be implemented to ensure the site drains properly will include weeping tile around the subgrade structures to protect them from differential settlement due to varying groundwater levels. Below grade structures will be backfilled with granular backfill and will utilize perimeter drainage systems. With the high water table, it is anticipated that the raft slab foundations will be placed at relatively shallow depths (less than 2.0 m). With the implementation of these design measures, the impact from building construction on the groundwater is expected to be negligible.

Groundwater quality has the potential to be affected by the release of contaminants from accidental spills and improper storage and disposal of waste generated at the site. Additionally, leaks from pipelines conveying wastewater could affect groundwater quality. Given the coarse grained soil and shallow groundwater table, the potential negative effects of an accidental release are expected to be moderate, short-term and would extend from the project site to the immediately surrounding project area.

#### **5.2.6.2 Operation**

During the operational phase, treated effluent will be continuously discharged to the discharge channel, and subsequently into Gopher Creek, and eventually the Assiniboine River. Some infiltration is expected

based on the coarse nature of the shallow soils at the project site and surrounding project area. As noted in the discussion on surface water quality (Section 5.2.7), the treated effluent to be discharged to the environment will be improved in quality by a significant amount, and will meet draft criteria established by Manitoba Conservation that are prescriptive for the protection of the environment.

The disposal of biosolids and screenings at the Town of Virден landfill facility has the potential to impact groundwater quality through improperly managed surface runoff and/or leakage of leachate into the groundwater. However, the sludge drying bed cells at the Town of Virден landfill have been constructed to prevent infiltration and surface runoff.

The delivery and storage of diesel fuel at the project site for use in the standby generators, and the delivery, storage and use of chemicals (chlorine during Phase I operation and alum and polymers during both phases) could impact the groundwater if an accidental release to the environment were to occur. The design of the aboveground fuel storage tanks and chemical room has been completed in accordance with regulations and guidelines to contain spills, should they occur.

### **5.2.6.3 Mitigation Measures**

Mitigation measures to reduce potential project effects on water quality include:

- Pressure test forcemain and wastewater pipelines prior to operation;
- Storage and handling of all potential contaminants and/or hazardous materials should be in accordance with established guidelines and regulations, including all federal and provincial standards and protocols;
- Emergency response plans, procedures and equipment to address the accidental release of fuel, chemicals or other hazardous materials, should be prepared to minimize the effects should an accidental release occur; and
- Effluent that is discharged should be sampled and tested for compliance with the Environment Act License terms and conditions.

### **5.2.6.4 Residual Effects after Mitigation**

Residual effects to groundwater quality could include the discharge of hazardous materials from accidental releases of fuels and chemicals. The discharge of treated effluent is expected to result in a negligible effect to groundwater quality. The residual effects to groundwater quality after mitigation are considered to be small in magnitude, limited to the project site and immediate project area, and long-term in duration. As a result, the potential residual effect is determined to be not significant.

## **5.2.7 Surface Water Quality**

### **5.2.7.1 Construction**

There are no surface water features located on the project site. The closest surface water feature to the construction site is the effluent discharge channel that flows into Gopher Creek. Construction activities

have the potential to affect surface water quality through sedimentation and spills of contaminants such as fuels, chemicals and wastewater.

Wind and precipitation and/or runoff could cause soil erosion during construction activities, including clearing and grubbing, excavation work, stockpiling materials and equipment/vehicle movement. Soil erosion can cause subsequent effects to surface water quality downstream of the project site (and also aquatic resources) in the immediately surrounding project area as a result of sediment accumulation and turbidity.

Surface water quality has the potential to be affected by the release of contaminants from accidental spills, and improper storage and disposal of waste generated at the site. Additionally, leaks from pipelines conveying wastewater could affect surface water quality. The potential negative effects of an accidental release are expected to be moderate, short-term and would extend from the project site to the immediately surrounding project area.

#### **5.2.7.2 Operation**

During the operational phase, treated effluent will be continuously discharged to the discharge channel, where it will flow about 175 m before discharging into Gopher Creek, and eventually the Assiniboine River. At the expected discharge rate of 0.014 m<sup>3</sup>/s (1,215 m<sup>3</sup>/day), the effluent is expected to contribute less than 14% of the flow in Gopher Creek during summer months, using a conservative estimate of 0.1 m<sup>3</sup>/s for Gopher Creek (without accounting for Scallion and Bosshill Creek contributions). During spring melt, effluent from the Virден WWTF would contribute less than 1.2% of the flow in Gopher Creek. The outfall has been sized to accommodate the ultimate peak wet weather flow of 5,625 m<sup>3</sup>/day (0.065 m<sup>3</sup>/s). At these flow rates, the effluent would contribute a higher percentage of the overall flow in Gopher Creek, however, in situations approaching the ultimate peak wet weather flow, a large increase in the flow in Gopher Creek would also be expected.

The draft effluent quality discharge criteria that have been used to design the Virден WWTF mean that significant water quality improvements will be experienced in the discharged treated effluent compared with the existing conditions. Using the May 2012 sampling results to represent the current baseline conditions, total suspended solids in the treated effluent are expected to be reduced by about 80%, coliforms will be reduced by more than 99%, biological oxygen demand will be reduced by 75% and ammonia will be reduced by about 50%. These reductions will be phased in, with a portion occurring after the Phase I operation is initiated, and the remaining improvements realized after Phase II is completed. These improvements in treated effluent quality are expected to make significant improvements to the water quality in Gopher Creek immediately downstream of the mixing zone to at least 13 km downstream (which is the point where the current treated effluent discharge effects are felt, as evidenced by the return of the water quality parameters to normal background values at this point).

The disposal of biosolids and screenings at the Town of Virден landfill facility has the potential to impact surface water quality through improperly managed surface runoff and/or leakage of leachate into the groundwater with eventual discharge to surface water. However, the sludge drying bed cells at the Town of Virден landfill have been constructed to prevent infiltration and surface runoff. The Assiniboine River is located about 2 km east of the sludge drying beds.

The Town of Virден has expressed an interest in reuse of the dewatered biosolids, either as cover material at the landfill, or potentially other off-site uses, however, an ultimate end use has not yet been established. Additional assessment and licensing of these uses may be required and could be addressed through an alteration to the waste disposal ground license or the Virден WWTF license.

The delivery and storage of diesel fuel at the project site for use in the standby generators, and the delivery, storage and use of chemicals (chlorine during Phase I operation and alum and polymers during both phases) could impact the surface water if an accidental release to the environment were to occur. The design of the aboveground fuel storage tanks and chemical room has been completed in accordance with regulations and guidelines to contain spills, should they occur.

### **5.2.7.3 Mitigation Measures**

Mitigation measures to reduce potential project effects on water quality include:

- The mitigation measures noted above for soil quality (erosion) also mitigate effects on total suspended solids;
- Storage and handling of all potential contaminants and/or hazardous materials should be in accordance with established guidelines and regulations, including all federal and provincial standards and protocols;
- Refuelling and equipment maintenance activities should occur at least 100 m away from a water body and conducted in a manner designed to prevent the release of a deleterious substance into a water body;
- Emergency response plans, procedures and equipment to address the accidental release of fuel, chemicals or other hazardous materials, should be prepared to minimize the effects should an accidental release occur; and
- Effluent that is discharged should be sampled and tested for compliance with the Environment Act License terms and conditions.

### **5.2.7.4 Residual Effects after Mitigation**

Residual effects to water quality could include sedimentation from soil erosion and discharge of hazardous materials from accidental releases of fuels and chemicals. The discharge of treated effluent is expected to result in a negligible effect to water quality. The residual effects to water quality after mitigation are considered to be small in magnitude, limited to the project area and long-term in duration. As a result, the potential residual effect is determined to be not significant.

### **5.3 TERRESTRIAL ENVIRONMENT**

#### **5.3.1 Vegetation**

##### **5.3.1.1 Construction**

There is very limited terrestrial vegetation located within the project site, limited to a few mature trees on the north side of the lot along the south side of 3<sup>rd</sup> Avenue. These trees will not be affected by construction on the site. The remainder of the site contains either landscaped grass or gravel surfaced access paths and storage areas. The effect of construction on vegetation is negligible.

##### **5.3.1.2 Operation**

Operation of the Virден WWTP will involve continuous discharge of treated effluent to a surface drainage channel that flows into Gopher Creek, which flows into the Assiniboine River. The project will improve the quality of the current discharge in Phase I and further improve the effluent quality after Phase II. Given that the treated effluent discharge will meet criteria established by the Province of Manitoba to be prescriptive for protection of the environment, the potential effect of treated effluent discharge, both in Phase I and Phase II, is expected to be negligible on riparian vegetation.

Accidental releases of fuel, chemicals or raw and/or partially treated wastewater, could impact vegetation on the project site and the surrounding project area. No species of conservation concern were identified in the project area. This impact is expected to be small in nature, limited to the project site and immediately surrounding project area, and short-term.

##### **5.3.1.3 Mitigation Measures**

To mitigate potential effects on vegetation, the following mitigation measures will be implemented:

- Limit vehicle and equipment movements to designated areas to avoid damaging vegetation;
- Band any trees located near the work site to prevent damage from construction vehicles and equipment;
- Minimize surface disturbances and complete re-vegetation as soon as practicable; and
- Maintain a minimum of a 30 m riparian buffer adjacent to any watercourse.

##### **5.3.1.4 Residual Effects after Mitigation**

Residual effects to vegetation could include stress and/or damage from accidental releases of materials hazardous to vegetation, such as fuels and chemicals. The residual effects to vegetation after mitigation are considered to be small in magnitude, limited to the project area and medium-term in duration. As a result, the potential residual effect is determined to be not significant.



### **5.3.2 Wildlife**

#### **5.3.2.1 Construction**

Potential impacts to wildlife during construction are related to sensory disturbance from noise, vibration and human presence, and may result in short-term avoidance of the project site and immediately surrounding project area. Given that the project site provides little to no habitat, and current use would consist only of transient wildlife, these effects are considered negligible.

#### **5.3.2.2 Operation**

Wildlife may utilize the effluent discharge channel and Gopher Creek for watering. The release of treated effluent that meets the guidelines established by Manitoba Conservation is intended to be prescriptive for the protection of environmental health, including wildlife. The effect of operation of the Virден WWTF on wildlife is expected to be negligible.

#### **5.3.2.3 Mitigation Measures**

To mitigate potential effects on wildlife, the following mitigation measures will be implemented:

- If vegetation clearing is required at the project site (removal of trees), check the trees for nests and avoid clearing activities during critical nesting periods (usually April 1 to July 31).

#### **5.3.2.4 Residual Effects after Mitigation**

The effect of the project construction and operation on wildlife is expected to be negligible. As a result, residual effects are not expected.

## **5.4 AQUATIC RESOURCES AND HABITAT**

### **5.4.1 Fish and Fish Habitat**

#### **5.4.1.1 Construction**

During construction of the Virден WWTF, increases in surface water runoff could occur and cause negative effects on fish and fish habitat through increased sedimentation and the introduction of potential contaminants and harmful substances to the waterbodies. Given the natural attenuation expected from the vegetation in the effluent drainage channel, the potential effect of increased surface runoff and/or sedimentation on fish and fish habitat is expected to be small, limited to the immediately surrounding project area, and short-term in duration. The mitigation measures proposed to protect surface water quality are also sufficient to protect the aquatic resources near the project site.

Similarly, the potential for impacts to surface water, and subsequently, fish and fish habitat, was identified due to the release of potentially harmful substances such as fuels, chemicals, wastewater or other

hazardous substances. Given the distance a spill or leak that occurred during construction at the project site would have to travel to reach the nearest surface water body that potentially supports aquatic life (Gopher Creek), the potential effect is expected to be small, limited to the immediately surrounding project area, and short-term in duration.

#### **5.4.1.2 Operation**

As noted in the Surface Water Quality discussion (Section 5.2.7), treated effluent will be continuously discharged to the discharge channel, and subsequently into Gopher Creek, and eventually the Assiniboine River. The effluent is expected to contribute less than 14% of the flow in Gopher Creek during summer months and less than 1.2% of the flow during spring melt.

The draft effluent quality discharge criteria that have been used to design the Virден WWTF mean that significant water quality improvements will be experienced in the discharged treated effluent compared with the existing conditions. Total suspended solids in the treated effluent are expected to be reduced by about 80%, coliforms will be reduced by more than 99%, biological oxygen demand will be reduced by 75% and ammonia will be reduced by about 50%. These reductions will be phased in, with a portion occurring after the Phase I operation is initiated, and the remaining improvements realized after Phase II is completed. These improvements in treated effluent quality are expected to make significant improvements to the water quality in Gopher Creek.

Discharge of treated effluent via the effluent drainage channel before the outlet to Gopher Creek will mitigate potential temperature effects from the effluent and allows for cooling to ambient temperature before entering a potentially fish-bearing waterbody.

Given the above, the potential impacts to fish and fish habitat resulting from the discharge of treated effluent during operation of the Virден WWTF are expected to be negligible.

The disposal of biosolids and screenings at the Town of Virден landfill facility has the potential to impact surface water quality, and subsequently, fish and fish habitat, through improperly managed surface runoff and/or leakage of leachate into the groundwater with eventual discharge to surface water. However, the sludge drying bed cells at the Town of Virден landfill have been constructed to prevent infiltration and surface runoff. The Assiniboine River is located about 2 km east of the sludge drying beds. The potential effect is expected to be negligible.

The delivery and storage of diesel fuel at the project site for use in the standby generators, and the delivery, storage and use of chemicals (chlorine during Phase I operation and alum and polymers during both phases) could impact the surface water if an accidental release to the environment were to occur. The design of the aboveground fuel storage tanks and chemical room has been completed in accordance with regulations and guidelines to contain spills, should they occur.

Based on these factors, operation of the Virден WWTF may cause potential effects within Gopher Creek that are expected to be small in magnitude, limited to the project area in geographic extent, and long-term in duration. As a result, the potential residual effect is determined to be not significant.

#### **5.4.1.3 Mitigation Measures**

The mitigation measures described to avoid/minimize project effects on water quality are applicable to fish and fish habitat.

#### **5.4.1.4 Residual Effects after Mitigation**

The operation of the Virден WWTF may cause potential effects within Gopher Creek in the project area immediately downstream of the outfall location that are expected to be small in magnitude, limited to the project area in geographic extent, and long-term in duration. As a result, the potential residual effect is determined to be not significant.

### **5.5 SOCIO-ECONOMIC ENVIRONMENT**

#### **5.5.1 Land and Resource Use**

##### **5.5.1.1 Construction**

During construction, there will be positive direct effects resulting from the project related to employment opportunities, and indirect positive effects related to an increased capacity and more reliable wastewater treatment system that can support future demand stemming from residential, industrial, and commercial growth in the Town and the surrounding area. The land use at the Virден WWTF project site will remain industrial and no effects are anticipated in this regard.

##### **5.5.1.2 Operation**

During operation, a net positive benefit to land and resource use is anticipated, as the Virден WWTF will produce a much higher quality effluent for discharge to the receiving environment, thereby improving surface water quality downstream and subsequently, improving potential for increased use of Gopher Creek for recreation and resource use.

##### **5.5.1.3 Mitigation Measures**

No effects were identified for land and resource use and no mitigation measures are proposed.

##### **5.5.1.4 Residual Effects after Mitigation**

Since no effects were identified for land and resource use resulting from the project, the residual effects are determined to be negligible.

## **5.5.2 Transportation**

### **5.5.2.1 Construction**

An increase in traffic on the local roads in the industrial zoned area surrounding the project site will likely be noticeable for the duration of the construction activities. The collector and regional streets in the Town of Virден are not likely to be impacted given current traffic flows. The impact is expected to be moderate, limited to the project site and surrounding project area, and short-term in nature.

### **5.5.2.2 Operation**

Staff levels during operation will be similar to those that currently exist, therefore, no impacts on traffic are anticipated. Projected levels of septage hauling, at up to six trucks per day, and biosolids removal, at up to three trucks per week, are also similar to those currently experienced at the facility and on the transportation route to the Town of Virден landfill facility. The effects on traffic due to operation of the facility are expected to be negligible.

### **5.5.2.3 Mitigation Measures**

To address potential traffic issues during construction, the following mitigation measures are provided:

- In the event that local roads are damaged due to increased traffic during construction, the Town of Virден will complete the necessary repairs;
- The surrounding property owners (industrial and commercial) should be notified before construction starts and kept informed of potential road closures for large equipment deliveries or movement;
- Alternate access to businesses surrounding the project site should be provided if local roads require restrictions or closing;
- Off-street parking areas should be provided for construction workers to the extent practicable;
- All construction workers and delivery drivers should be reminded of safe-driving habits and local speed limits; and
- Transportation routes for equipment and material deliveries, and for biosolids removal should be developed that avoid residential neighbourhoods as much as possible.

### **5.5.2.4 Residual Effects after Mitigation**

The increase in traffic during construction and operation of the Virден WWTF may cause potential effects that are expected to be small in magnitude, limited to the project area in geographic extent, and long-term in duration. As a result, the potential residual effect is determined to be not significant.

### **5.5.3 Recreation and Tourism**

#### **5.5.3.1 Construction**

There are no recreational and tourism opportunities at the project site, which is a disturbed industrial property surrounded by industrial and agricultural land use. There are limited recreation and tourism uses in the surrounding project area. Construction of the Virден WWTF is anticipated to cause negligible effects on recreation and tourism.

#### **5.5.3.2 Operation**

The operation of a wastewater treatment facility that meets current environmental legislation and improves the surface water quality in Gopher Creek will cause a net positive effect on recreation and tourism opportunities in the project area.

#### **5.5.3.3 Mitigation Measures**

No potential effects on recreation and tourism were identified and no mitigation measures are proposed.

#### **5.5.3.4 Residual Effects after Mitigation**

There are no residual effects on recreation and tourism predicted as a result of the project.

## **5.6 HERITAGE AND CULTURAL RESOURCES**

### **5.6.1 Construction**

No heritage or cultural resources were identified for the project site, and there are no disturbances anticipated for areas beyond the project site boundaries. There is the potential that heritage resources could be encountered during excavation at the project site. The potential impacts would be small, limited to the project site and short-term in duration.

### **5.6.2 Operation**

No additional ground disturbance is expected during operation of the project, therefore, there are no anticipated project effects during operation on heritage and cultural resources.

### **5.6.3 Mitigation Measures**

To mitigate the potential effects on heritage and cultural resources, the following mitigation measures will be implemented:

- If artifacts, historical features or human remains are encountered during construction, work activities should be stopped immediately at the area of the discovery and the find reported to the site supervisor and Town of Virден;

- A qualified archaeologist may be required to investigate and assess the discovery prior to resuming work; and
- If human remains are discovered during construction activities, the find should be immediately reported to the site supervisor, Town of Virден and the RCMP.

#### **5.6.4 Residual Effects after Mitigation**

The construction of the Virден WWTF may cause potential effects to heritage and cultural resources from disturbance of artifacts, historical features and/or human remains. With the implementation of the mitigation measures, the residual effects to heritage and cultural resources and expected to be negligible.

## **6.0 ACCIDENTS AND MALFUNCTIONS**

The types of potential accidents and malfunctions that may occur during the construction and operation of the Virten WWTF include fires and explosions, spills, equipment malfunctions, and transportation accidents. The effects of these accidents and malfunctions, proposed mitigation measures, and significance of residual effects, are discussed below.

To prevent accidents and malfunctions, the construction and operation of the facility will be conducted in accordance with regulatory requirements. Additional precautionary measures are proposed below to mitigate accidents and malfunctions. Worker protection in Manitoba is provided through standards, procedures and training legislated under the Workplace Safety and Health Act. All activities at the project site should be carried out in accordance with the Workplace Safety and Health Act to minimize health and safety effects.

### **6.1 FIRE**

During construction, fires and/or explosions may be possible as a result of propane heater use, welding/cutting, sparks during fuelling, equipment malfunctions, improper storage of hazardous materials, and other construction and demolition activities. During operation, diesel fuel use for the standby generators is also a potential fire and explosion hazard. The use of alum and chlorine during operation of the Virten WWTF does not typically present a fire or explosion risk.

Potential effects related to fires and explosions include property loss, loss of life, loss of vegetation and wildlife habitat, and the release of hazardous materials into the environment.

Mitigation measures that will be implemented to reduce the potential for fires and explosions include:

- All flammable waste will be removed on a regular basis and disposed at an appropriate disposal site;
- Fire extinguisher(s) will be available on-site at all times during all phases of the project, and will comply with and be maintained to the manufacturer's standards;
- Greasy/oily rags or materials subject to spontaneous combustion will be deposited and stored in appropriate containers and removed from the site on a regular basis for disposal at an appropriate disposal site;
- All chemicals and fuel will be stored in appropriate facilities that have been designed and constructed in compliance with provincial legislation, codes and guidelines;
- Smoking will only be allowed in designated outdoor areas that contain appropriate receptacles for disposal of cigarette butts; and
- An emergency response plan will be developed prior to construction that includes fire and explosion prevention, notification protocols and safe muster areas.

## 6.2 SPILLS

During construction and operation, environmental effects resulting from fuel, chemical and wastewater spills are possible. The accidental release of these hazardous substances to the environment could affect air quality, soil, groundwater, vegetation, wildlife and fish, and fish habitat. In addition, an accidental release could cause a direct threat to human health and safety.

To prevent spills from occurring during the project construction and operation, the following procedures will be employed:

- All potentially hazardous products required to be present on-site will be stored in a pre-designated, safe and secure product storage area(s) in accordance with applicable legislation;
- Storage sites will be inspected periodically for compliance with requirements;
- Any used oils or other hazardous liquids will be collected and disposed in compliance with provincial requirements;
- Vehicles and equipment will be maintained to minimize the potential for leaks. Regular inspection of hydraulic and fuel systems on equipment and machinery will be performed. When detected leaks will be repaired immediately by trained personnel;
- Refuelling and equipment maintenance will occur at least 100 m away from a waterbody or drainage feature leading to a waterbody, and will be conducted in a manner designed to prevent the release of a hazardous substance;
- Fuel transfers, including from tanker to storage tank and storage tank to equipment, will be attended and monitored at all times;
- Standard environmental management practices will be adhered to in order to minimize the risk of accidental spills and potential effects;
- An emergency spill response plan will be prepared and contain procedures for responding to a spill that include: reporting to the Town of Virден, Manitoba Conservation and Environment Canada as appropriate; taking immediate measures with a spill kit or other suitable alternative to prevent migration of the spill, implementing recovery measures in consultation with appropriate authorities; and undertaking remedial action to remove contaminated material;
- Training will be provided to on-site construction and operational staff to properly deploy spill response equipment and implement the spill response plan;
- Spill response equipment will be available on-site at all times during all phases of the project; and
- Concrete and concrete wash water will be appropriately disposed either through surface infiltration at a location at least 100 m from a waterbody or through the wastewater treatment plant.

The implementation of the above mitigation measures, in addition to the design and operation of the facility in accordance with all applicable legislation and codes, is expected to result in residual effects that are considered small, limited to the project site and immediately surrounding area, and long-term in duration. As a result, the residual effects are considered to be not significant.



### **6.3 EQUIPMENT MALFUNCTION**

Equipment malfunctions related to pipe and pump failures could occur and release wastewater or chemicals to the environment. All new pipelines and pumps will be tested prior to operation in order to identify any potential issues, including pipeline leaks. Regular inspection of pumps and accessible pipelines will be conducted by the Town of Virден personnel operating the Virден WWTF. All pipelines installed will be suitable for cold weather climates and insulated/heat traced to prevent cracking and/or failure due to freezing. With a design that meets applicable codes of practice, the potential effect of equipment malfunction is expected to be negligible.

### **6.4 TRANSPORTATION ACCIDENTS**

Transportation accidents can result in the accidental release of vehicle fluids such as diesel, oil and gasoline and the release of the material being transported, such as diesel, chlorine, alum, wastewater and biosolids. The potential environmental effects from an accidental release during transportation would include air, soil, groundwater, surface water, vegetation, wildlife, fish and fish habitat, land and resource use and human health.

Mitigation measures related to traffic have been previously described and will mitigate the potential for accidents to the extent practicable. In the event of a transportation accident resulting in a spill, appropriate notification to the Town of Virден and Manitoba Conservation will occur, and remediation measures will be coordinated, as required, and based on the nature of the spilled material.

After implementation of mitigation measures, the potential residual effects of a transportation accident are expected to be small, limited to the project site and project area, and short-term in duration. As a result, the residual effects are considered to be not significant.

## **7.0 EFFECTS OF THE ENVIRONMENT ON THE PROJECT**

### **7.1 SEVERE WEATHER**

Climatic conditions in the project area/regional project area can be harsh, and include extreme high and low temperatures, damaging winds, significant precipitation, lightning strikes, hail and possibly tornados.

Mitigation measures associated with severe weather events will include:

- Proper hoarding of construction activities and material stockpiles;
- Providing protection for workers during construction;
- Suspending construction during periods of severe weather;
- Providing emergency pumps and standby power sources;
- Design of all buildings and systems to meet applicable codes.

With the implementation of the above mitigation measures, the potential residual effects on the project resulting from severe weather are expected to be negligible.

### **7.2 FLOOD**

The Virден WWTF is not located within a flood plain and does not require any flood-specific design parameters. The coarse soils present at the project site provide for a high rate of infiltration during precipitation events.

High water levels in Gopher Creek at the outlet from the effluent drainage channel could cause some backflow up the channel and release treated effluent into the surrounding land. The treated effluent will meet the requirements for surface discharge and is not expected to cause a deleterious effect in the environment. The potential effect of flooding on the Virден WWTF was determined to be negligible.

### **7.3 DROUGHT**

In cases of severe drought, flows in Gopher Creek at the outlet of the effluent drainage channel may be severely limited and the discharge from the Virден WWTF could make up a significant portion of the overall flow downstream. Given that the treated effluent will meet the draft discharge criteria, this is not expected to cause an environmental effect, and may be beneficial in terms of maintaining a base flow in the creek downstream of the outlet.

### **7.4 SEISMIC ACTIVITY**

The Virден WWTF will be designed to meet the requirements for seismic safety outlined in the National Building Code of Canada. Virден is not located within an earthquake hazard area and seismic activity is not expected to affect the project.

## **8.0 MONITORING AND FOLLOW-UP**

This EAP will form part of the tender specifications for all phases of the project to ensure that the Contractor is aware of the mitigation measures described herein. Environmental performance during construction of the project will be monitored by the Town of Virден and the Construction Management Team.

During the operation of the project, monitoring of the effluent quality will be conducted in accordance with the Environment Act License requirements in order to assess environmental performance and prevent environmental effects to surface water quality, fish and fish habitat.

## **9.0 CONCLUSION**

Based on the design of the Project and the implementation of mitigation measures identified in this environmental assessment, no significant negative environmental impacts are anticipated to occur as a result of the Viriden WWTF Upgrade Project.

## 10.0 REFERENCES

1. Associated Engineering (Sask.) Ltd., Town of Virден Wastewater Treatment Plant Feasibility Report Update, August 2013.
2. Associated Engineering (Sask.) Ltd., Town of Virден Wastewater Treatment Facility Upgrade Functional Design Report (90% Draft), October 2013.
3. Manitoba Water Stewardship, Manitoba Water Quality Standards, Objectives, and Guidelines, November 28, 2011.
4. Manitoba Conservation and Water Stewardship, Annual Air Quality Statistics. Obtained November 2013 from: <http://www.gov.mb.ca/conservation/envprograms/airquality/aq-info/index.html>.
5. Environment Canada, Canadian Climate Normals. Obtained November 2013 from: [http://climate.weather.gc.ca/climate\\_normals/](http://climate.weather.gc.ca/climate_normals/).
6. Agriculture and Agri-Food Canada, Land Resource Unit, Brandon Research Centre, Research Branch, Terrestrial Ecozones, Ecoregions and Ecodistricts of Manitoba - An Ecological Stratification of Manitoba's Natural Landscapes, 1998.
7. Manitoba Natural Resources, Water Resources, Groundwater Availability Map Series, Virден Area, 62F, 1983.
8. Manitoba Science, Technology, Energy and Mines, Manitoba Geological Survey, Surficial Geology Compilation Map Series of Manitoba, Second Edition, 2007.
9. Agriculture and Agri-Food Canada, Canada Land Inventory Maps. Obtained November 2013 from: <http://sis.agr.gc.ca/cansis/publications/maps/index.html>.
10. Manitoba Conservation and Water Stewardship, Arrow-Oak River, State of the Watershed Report, June, 2008.
11. Manitoba Conservation and Water Stewardship, Oak River Watershed Hydrology. Obtained November 2013 from: [http://www.gov.mb.ca/waterstewardship/iwmp/arrow\\_oak/arrow\\_oak.html](http://www.gov.mb.ca/waterstewardship/iwmp/arrow_oak/arrow_oak.html).
12. Environment Canada, Water Survey of Canada, Hydrometric Data, Station 05MG002. Obtained November 2013 from: <http://www.wsc.ec.gc.ca/applications/H2O/index-eng.cfm>.
13. Environment Canada, Water Survey of Canada, Hydrometric Data, Station 05MG003. Obtained November 2013 from: <http://www.wsc.ec.gc.ca/applications/H2O/index-eng.cfm>.

14. Environment Canada, Water Survey of Canada, Hydrometric Data, Station 05ME006. Obtained November 2013 from: <http://www.wsc.ec.gc.ca/applications/H2O/index-eng.cfm>.
15. Town of Virден, unpublished raw data, November 2013.
16. Rutulis, M., Groundwater Resources in the Virден - Wallace Planning District (A Synopsis), November, 1984.
17. Manitoba Conservation and Water Stewardship, Groundwater Management Section, GWdrill CD-ROM, May, 2006.
18. Statistics Canada. 2012. Virден, Manitoba (Code 4606034). Census Profile. 2011 Census. Statistics Canada Catalogue No. 98-316-XWE. Ottawa. Released October 24, 2012. <http://www12.statcan.gc.ca/census-recensement/2011/dp-pd/prof/index.cfm?Land=E> (accessed September 24, 2013).
19. Statistics Canada. 2013. Virден, T, Manitoba (Code 4606034) (table). National Household Survey (NHS) Profile. 2011 National Household Survey. Statistics Canada Catalogue No. 99-004-XWE. Ottawa. Released September 11, 2013. <http://www12.statcan.gc.ca/nhs-enm/2011/dp-pd/prof/index.cfm?Lang=E> (accessed September 30, 2013).
20. Assiniboine Regional Health Authority of Manitoba web page. Obtained November 2013 from: <http://www.assiniboine-rha.ca/index.php/>.
21. Town of Virден, Community Profile. Obtained November 2013 from: [http://www.virden.ca/page.aspx?page\\_id=1&title=Community](http://www.virden.ca/page.aspx?page_id=1&title=Community).
22. Manitoba Infrastructure and Transportation, Manitoba Highway Classification System. Obtained November 2013 from: <https://www.gov.mb.ca/mit/mcd/mcpd/mhcs.html>.
23. Virден Flying Training School, Virден Days: A Partial Record of No. 19 Elementary Flying Training School, R.C.A.F., Virден, Manitoba, Operated by the Virден Flying Training School, 1941-1944, 1945.)
24. Forsythe, Bruce, A Short History of Abandoned and Downsized Canadian Military Bases, <http://militarybruce.com/history/base-history.html> accessed October 1, 2013.)
25. Manitoba Historical Society, Historic Sites of Manitoba, Interactive Map. Obtained November 2013 from: <http://www.mhs.mb.ca/docs/sites/index.shtml>.
26. Aboriginal Affairs and Northern Development Canada, Treaties in Manitoba. Obtained October 2013 from: <http://aadnc-aandc.gc.ca/eng/1100100020406/1100100020407>.

27. Aboriginal Affairs and Northern Development Canada, First Nation Profiles. Obtained October 2013 from: <http://pse5-esd5.ainc-inac.gc.ca/fnp/Main/index.aspx?lang=eng>.
28. Manitoba Eco Network, Climate Change Connection, Manitoba GHG Emission Trend 1990 - 2011. Obtained November 2013 from: [http://www.climatechangeconnection.org/emissions/Manitoba\\_emissions.htm](http://www.climatechangeconnection.org/emissions/Manitoba_emissions.htm).
29. Monteith, Hugo D., Sahely, Halla R., MacLean, Heather L., and Bagley, David M., A Rational Procedure for Estimation of Greenhouse-Gas Emissions from Municipal Wastewater Treatment Plants, Water Environment Research, Volume 77, Number 4, July/August, 2005.





---

## FIGURES



8.5" x 11"

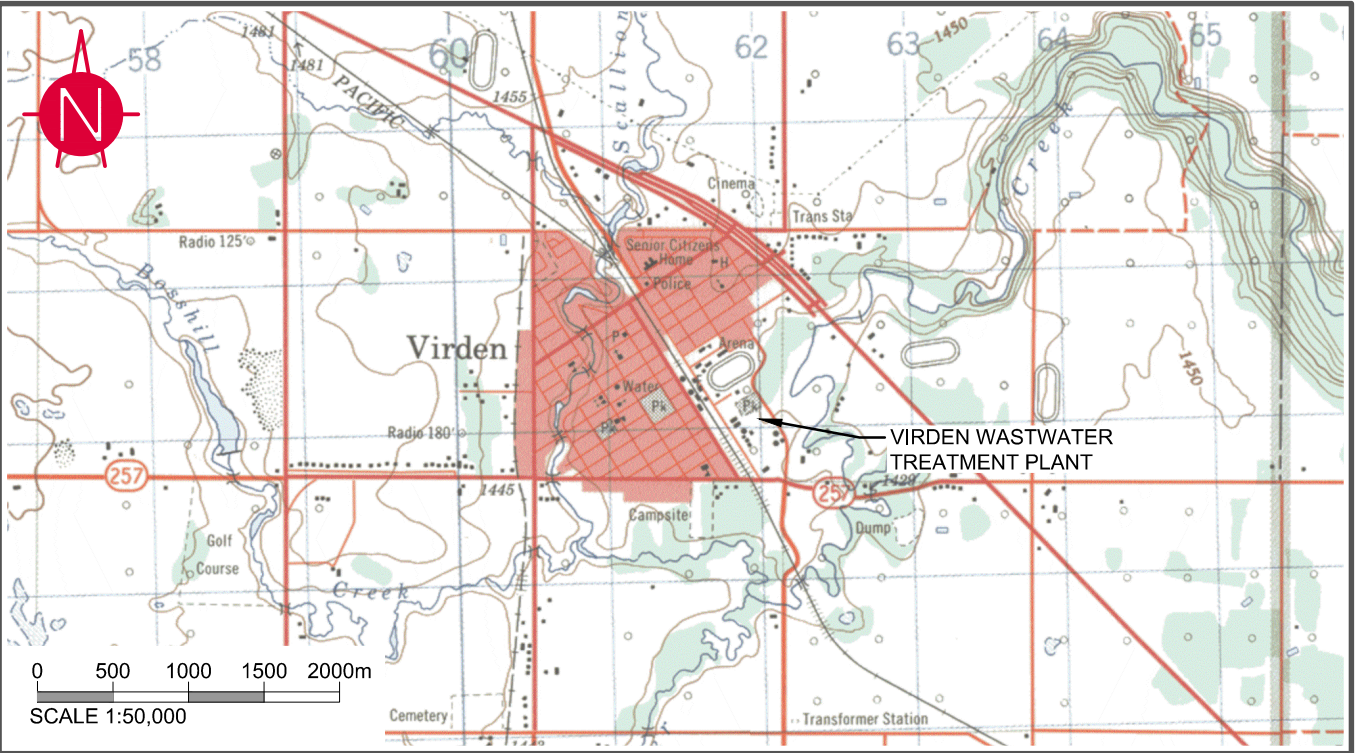

PLOT: 11/22/13 12:29:51 AM



EDGE FILE NAME: 0137-001-01\_01\_X.dwg

**EGE**

**Town of Virden**  
 Wastewater Treatment Facility Upgrade  
 Environmental Act Proposal

**Location  
Plan**

**Figure 01**













---

**APPENDIX A**  
**CLEAN ENVIRONMENT COMMISSION ORDER 1110**



11/0

AN ORDER OF THE CLEAN ENVIRONMENT COMMISSION  
UNDER THE CLEAN ENVIRONMENT ACT

---

RE: THE CLEAN ENVIRONMENT COMMISSION and THE TOWN OF VIRDEN, Applicant,

WHEREAS pursuant to the provisions of The Clean Environment Act, a proposal was filed with the department by Reid, Crowther and Partners Limited on behalf of the Town of Virden in connection with the operation of a sewage treatment plant located on Lots 12 and 13, Block 170, Plan 197 BL10 in the Town of Virden, Manitoba, with continuous discharge of effluent via an enclosed pipe to the Assiniboine River;

AND WHEREAS in the absence of limits prescribed by a regulation under the said Act, the proposal was referred to The Clean Environment Commission to prescribe limits;

AND WHEREAS after giving notice of the proposal the Commission held a hearing in Virden on the 17th day of October, 1977, and issued Order No. 760 on the 5th day of December, 1977, prescribing limits, terms and conditions including a requirement for the effluent to be conveyed to the Assiniboine River by an enclosed pipeline;

AND WHEREAS on the 13th day of December, 1977, the Applicant filed an appeal from the order with the minister and, on the 18th day of August, 1978, he, the minister, stayed the condition in the order requiring discharge of effluent via an enclosed pipeline;

AND WHEREAS on the 21st day of May, 1985, following extensive study of the effluent from the said sewage treatment plant and of the quality of the water in Gopher Creek, he, the minister, directed the Commission to hold a new hearing and issue a new order, pursuant to the provisions of Section 17(3)(e) of the act;

AND WHEREAS after awaiting preparation of an environmental report and recommendations by the department, the Commission held a hearing in Virden on the 28th day of October, 1986;

AND WHEREAS the Commission considered the matter on the 15th day of December, 1986;

Continued

- 2 -

TOWN OF VIRDEN

IT IS HEREBY ORDERED THAT

1. The Applicant shall not discharge effluent from the said sewage treatment plant
  - (a) where the organic content of the effluent, as indicated by the five day biochemical oxygen demand, is in excess of 30 milligrams per litre;
  - (b) where the nonfilterable residue content of the effluent is in excess of 30 milligrams per litre;
  - (c) where the faecal coliform content of the effluent, as indicated by the MPN index, is in excess of 200 per 100 millilitres of sample.
2. The Applicant shall maintain and operate the said sewage treatment plant in such a manner that
  - (a) the release of offensive odours is minimized;
  - (b) the contamination of groundwater is prevented;
3. The Applicant shall ensure that waste sludge produced by the sewage treatment plant is disposed of in a manner satisfactory to the Environmental Management Division.
4. The Applicant shall provide the necessary facilities and shall arrange for the taking and analysis of samples of the influent and effluent sewage of the said sewage treatment plant, and for the submission of analysis results, in a manner approved by the Environmental Management Division.
5. The Applicant shall measure the volume of effluent from the said sewage treatment plant and shall record and submit the measurement data in a manner satisfactory to the said Division.

Continued

- 3 -

TOWN OF VIRDEN

6. This Order replaces Order No. 760 which shall be and is hereby rescinded.

Order No. 1110

Dated at the City of Winnipeg

this 19th day of December, 1986.

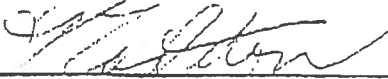
  
\_\_\_\_\_  
Chairman,  
The Clean Environment Commission.

File: 25.2

---

**APPENDIX B**  
**CERTIFICATE OF TITLE**

DATE: 2013/02/20  
TIME: 11:36

**MANITOBA**  
**STATUS OF TITLE**

TITLE NO: 2431730/2

PAGE: 1

STATUS OF TITLE..... ACCEPTED                      PRODUCED FOR..    X  
ORIGINATING OFFICE... BRANDON                      ADDRESS.....  
REGISTERING OFFICE... BRANDON  
REGISTRATION DATE.... 2010/02/09  
COMPLETION DATE..... 2010/02/09  
  
CLIENT FILE...    NA  
PRODUCED BY...    STUDENT.FIVE

**LEGAL DESCRIPTION:**

THE TOWN OF VIRDEN

IS REGISTERED OWNER SUBJECT TO SUCH ENTRIES RECORDED HEREON IN THE FOLLOWING DESCRIBED LAND:

PARCEL ONE: LOTS 6, 7, 11, 12 AND 13 BLOCK 170 PLAN 197 BLTO  
EXC FIRSTLY: OF OUT SAID LOT 7, THE SELY 38.8 FEET  
AND SECONDLY: OF SAID LOTS 7, 11, 12 AND 13,  
PUBLIC LANE PLAN 27609 BLTO  
IN E 1/2 22-10-26 WPM

PARCEL TWO: ALL MINES AND MINERALS IN THE FOLLOWING DESCRIBED  
LAND AS SET FORTH IN TRANSFER R55421:  
LOT 9 AND THE SELY 23.8 FEET OF LOT 8  
BLOCK 170 PLAN 197 BLTO  
IN E 1/2 22-10-26 WPM

PARCEL THREE ALL MINES AND MINERALS IN THE FOLLOWING DESCRIBED  
LAND AS SET FORTH IN TRANSFER R100662:  
LOT 8 AND THE SELY 38.8 FEET OF LOT 7  
BLOCK 170 PLAN 197 BLTO  
EXC OUT OF SAID LOT 8, THE SELY 23.8 FEET  
IN E 1/2 22-10-26 WPM

**ACTIVE TITLE CHARGE(S):**

**NO ACTIVE TITLE CHARGES EXIST ON THIS TITLE**

**ADDRESS(ES) FOR SERVICE:**  
EFFECT    NAME AND ADDRESS

POSTAL CODE

ACTIVE    TOWN OF VIRDEN  
          BOX 310  
          VIRDEN MB

ROM 2C0

**ORIGINATING INSTRUMENT(S):**  
REGISTRATION NUMBER    TYPE

REG. DATE

CONSIDERATION

SWORN VALUE

1259350/2    ITREQ    2010/02/09                      \$0.00                      \$0.00  
PRESENTED BY: MCNEILL HARASYMCHUK MCCONNELL  
FROM:    BLTO  
TO:

**FROM TITLE NUMBER(S):**

2377130/2    BAL

CERTIFIED TRUE EXTRACT PRODUCED FROM THE LAND TITLES DATA  
STORAGE SYSTEM ON 2013/02/20 OF TITLE NUMBER 2431730/2

DATE: 2013/02/20  
TIME: 11:36

**MANITOBA**  
**STATUS OF TITLE**

TITLE NO: 2431730/2

PAGE: 2

STATUS OF TITLE.....	ACCEPTED	PRODUCED FOR..	X
ORIGINATING OFFICE...	BRANDON	ADDRESS.....	
REGISTERING OFFICE...	BRANDON		
REGISTRATION DATE....	2010/02/09		
COMPLETION DATE.....	2010/02/09		
		CLIENT FILE...	NA
		PRODUCED BY...	STUDENT.FIVE

**LAND INDEX:**

LOT	BLOCK	SURVEY PLAN
6	170	197
NOTE:	E 1/2 22-10-26W	
7	170	197
NOTE:	E 1/2 22-10-26W-EX SE 38.8' OTHER THAN M&M EX PL27609	
8	170	197
NOTE:	E 1/2 22-10-26W	ALL M&M
9	170	197
NOTE:	E 1/2 22-10-26W	M&M
11	170	197
NOTE:	E 1/2 22-10-26W	EX LANE PL 27609
12	170	197
NOTE:	E 1/2 22-10-26W	EX LANE PL 27609
13	170	197
NOTE:	E 1/2 22-10-26W	EX LANE PL 27609

ACCEPTED THIS 9TH DAY OF FEBRUARY, 2010  
BY K.GRAINGER FOR THE DISTRICT REGISTRAR OF  
THE LAND TITLES DISTRICT OF BRANDON.

CERTIFIED TRUE EXTRACT PRODUCED FROM THE LAND TITLES DATA  
STORAGE SYSTEM ON 2013/02/20 OF TITLE NUMBER 2431730/2.

\*\*\*\*\* END OF STATUS OF TITLE 2431730/2 \*\*\*\*\*



---

**APPENDIX C**  
**FUNCTIONAL DESIGN DRAWINGS**

**PHASE II: BLOWER/UV BUILDING**  
MECHANICAL EQUIPMENT, CHEMICAL  
FEED AND UV DISINFECTION BUILDING

**PHASE II: NEW SBR TANKAGE**  
CAST IN PLACE CONCRETE TANKS  
(6.5m TALL, PARTIALLY BURIED)

PHASE II  
PHASE I

**PHASE I: NEW HEADWORKS BUILDING**  
2-STOREY CAST IN PLACE CONCRETE  
AND MASONRY BLOCK

**EXISTING SEWAGE TREATMENT PLANT**

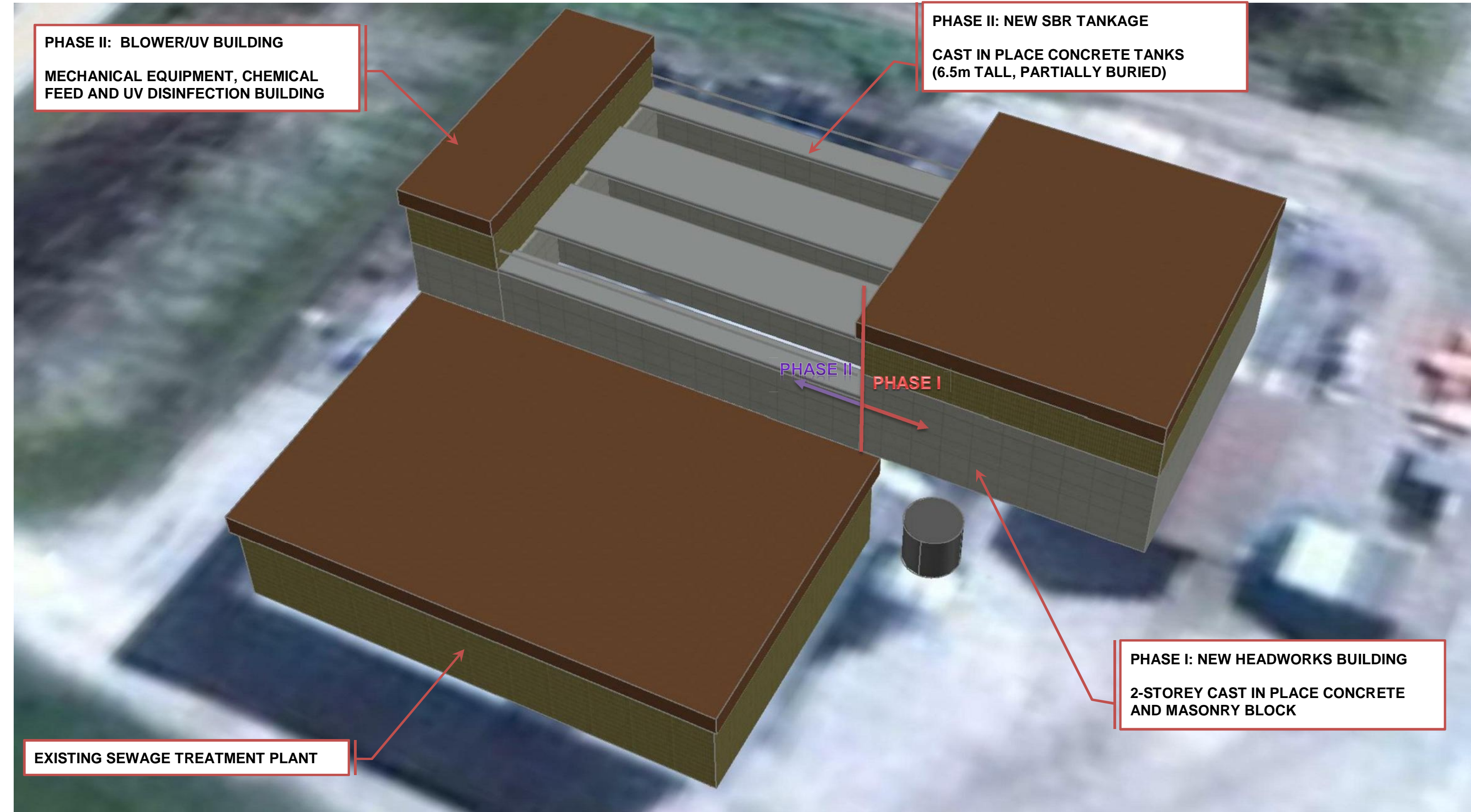

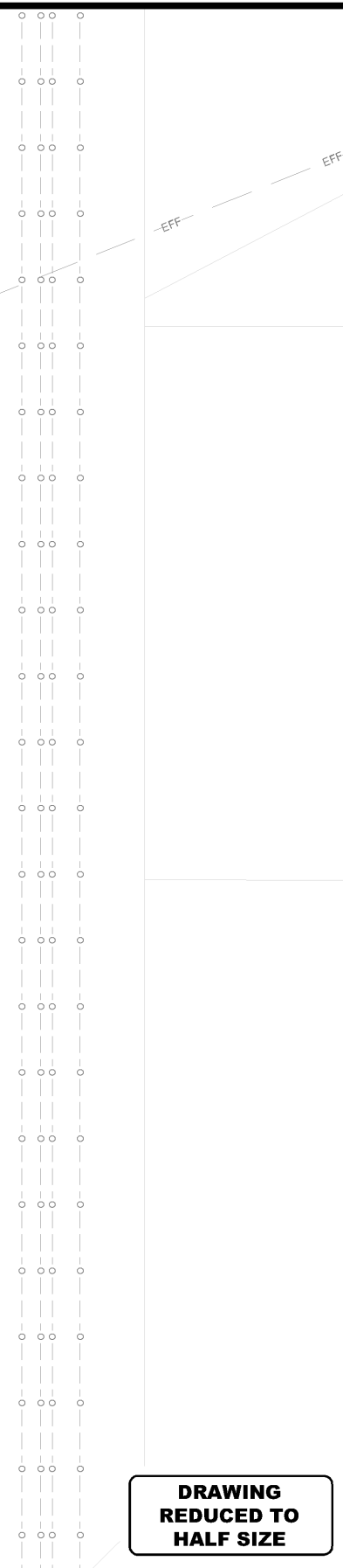
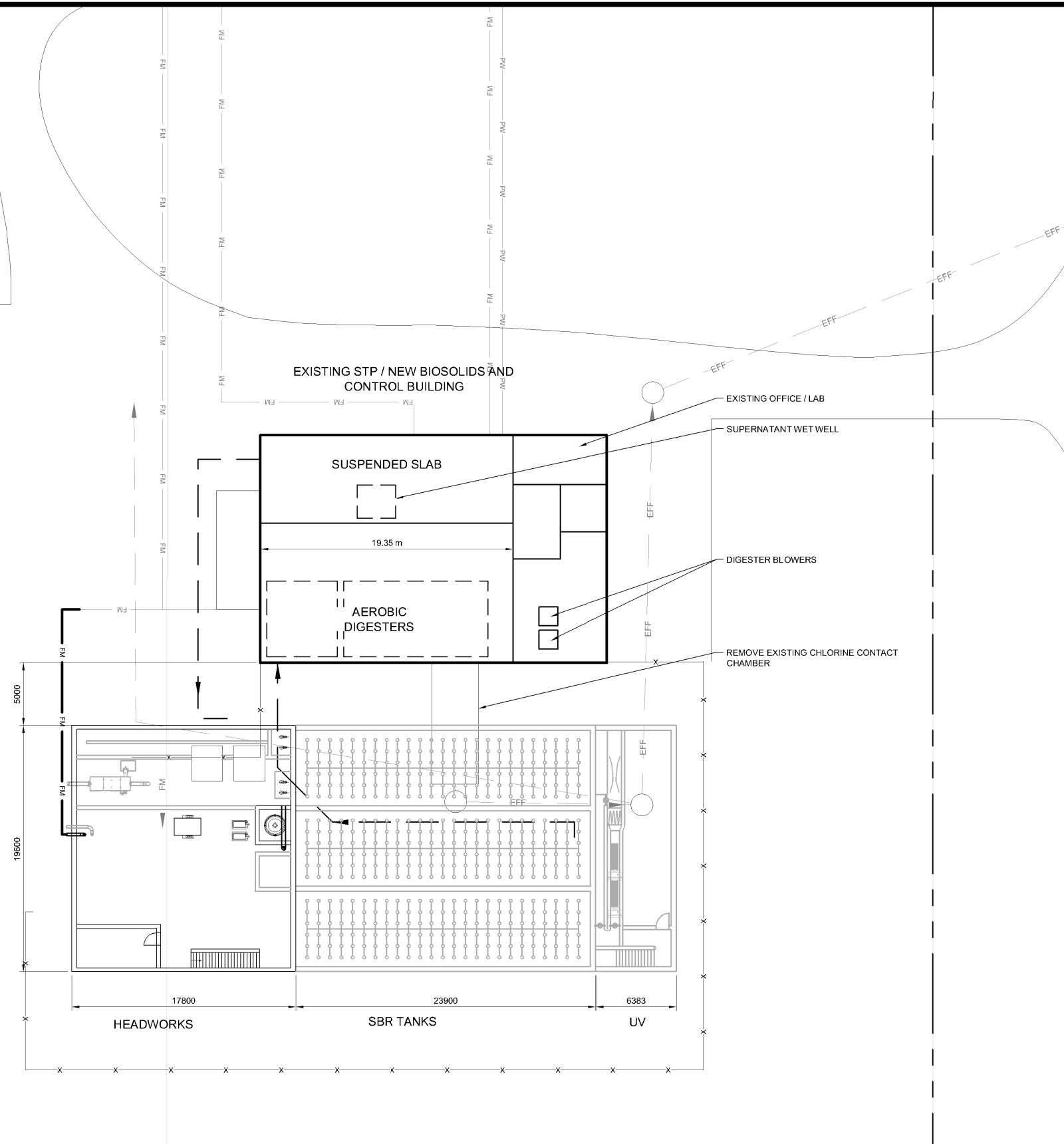

**DRAWING  
REDUCED TO  
HALF SIZE**

NO.	DATE	ENG.	BY	SUBJECT
A	JUNE 2013	P.S.	A.V.	UPDATED FEASIBILITY STUDY
REVISIONS				

**PRELIMINARY  
NOT FOR  
CONSTRUCTION**



PROJECT No.	2013-4246
SCALE	AS SHOWN
DRAWN	A.V.
DESIGNED	P.S.

MANITOBA WATER SERVICES BOARD &  
TOWN OF VIRDEN  
CIVIL  
SITE PLAN

VIRDEN WWTP UPGRADES		
DRAWING NUMBER	REV. NO.	SHEET
4246-00-101	A	1 / 1

This Drawing is For The Use Of The Client And Project Indicated  
No Representations Or Any Kind Are Made To Other Parties

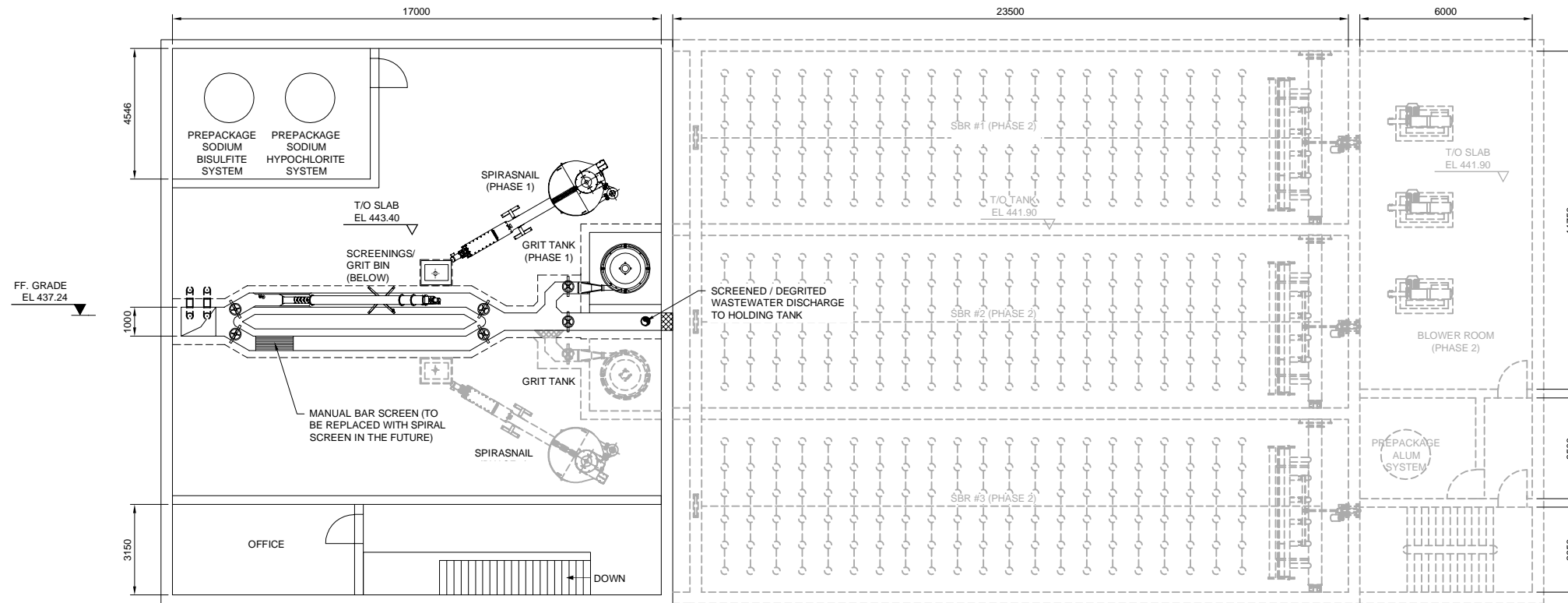

PLAN 1:100  
SECOND FLOOR  
47300

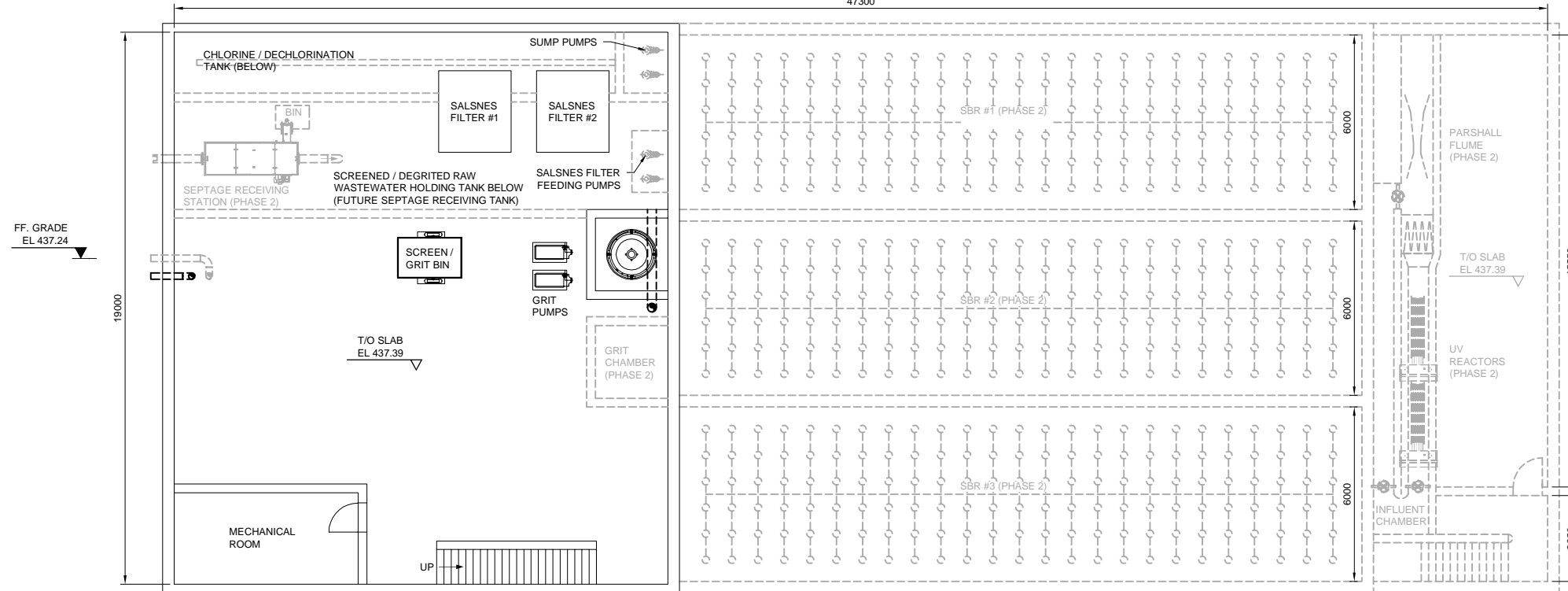

PLAN 1:100  
GROUND FLOOR  
47300

V:\projects\2013\4246\000\_700\_WWTP\_Upgrade\Working\_Drawings\_Planets\_Mech250.dwg  
DATE: 2013-05-21 10:41:10 AM

NO.	DATE	ENG.	BY	SUBJECT
A	JUNE 2013	P.S.	A.V.	POTENTIAL PHASING REPORT
REVISIONS				



PROJECT No.	2013-4246
SCALE	N.T.S.
DRAWN	K.Y.
DESIGNED	P.S.
CHECKED	
APPROVED	
DATE	

<b>MANITOBA WATER SERVICES BOARD AND TOWN OF VIRDEN</b>	<b>M.W.S.B. No. VIRDEN WWTP UPGRADES</b>		
	HEADWORKS/SBR/UV ROOM PLAN AT GROUND FLOOR / SECOND FLOOR	DRAWING NUMBER	REV. NO.
	4246-00-405	A	SHEET
			1 / 1

This Drawing is For The Use Of The Client And Project Indicated  
No Representations Or Any Kind Are Made To Other Parties

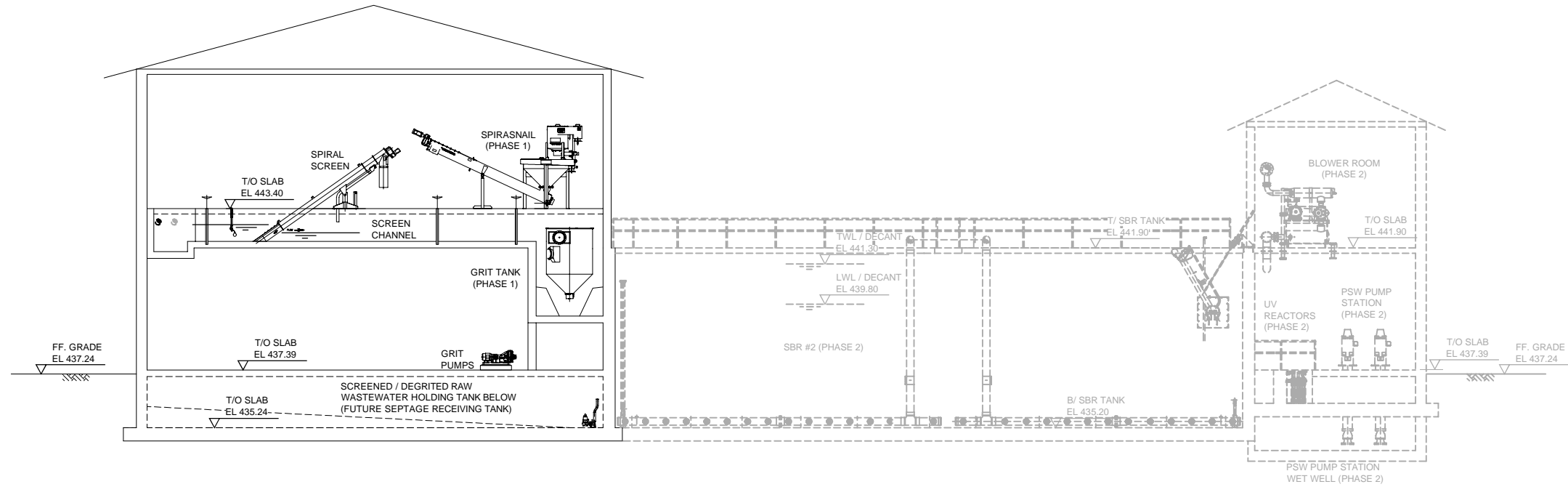

**A** SECTION 1:100  
405

V:\projects\101\1014246\1014246\_001\_WWTP\_Upgrade\Working\_Drafts\101\_Potential Phasing Report.dwg  
DATE: 2013-06-20 10:52 AM

NO.	DATE	ENG.	BY	SUBJECT
A	JUNE 2013	P.S.	A.V.	POTENTIAL PHASING REPORT
REVISIONS				



PROJECT No.	2013-4246
SCALE	N.T.S.
DRAWN	K.Y.
DESIGNED	P.S.
CHECKED	
APPROVED	
DATE	

**MANITOBA WATER SERVICES BOARD  
AND TOWN OF VIRDEN**

**HEADWORKS/SBR/UV ROOM  
SECTION A**

<b>M.W.S.B. No.</b> VIRDEN WWTP UPGRADES		
DRAWING NUMBER	REV. NO.	SHEET
4246-00-406	A	1 / 1

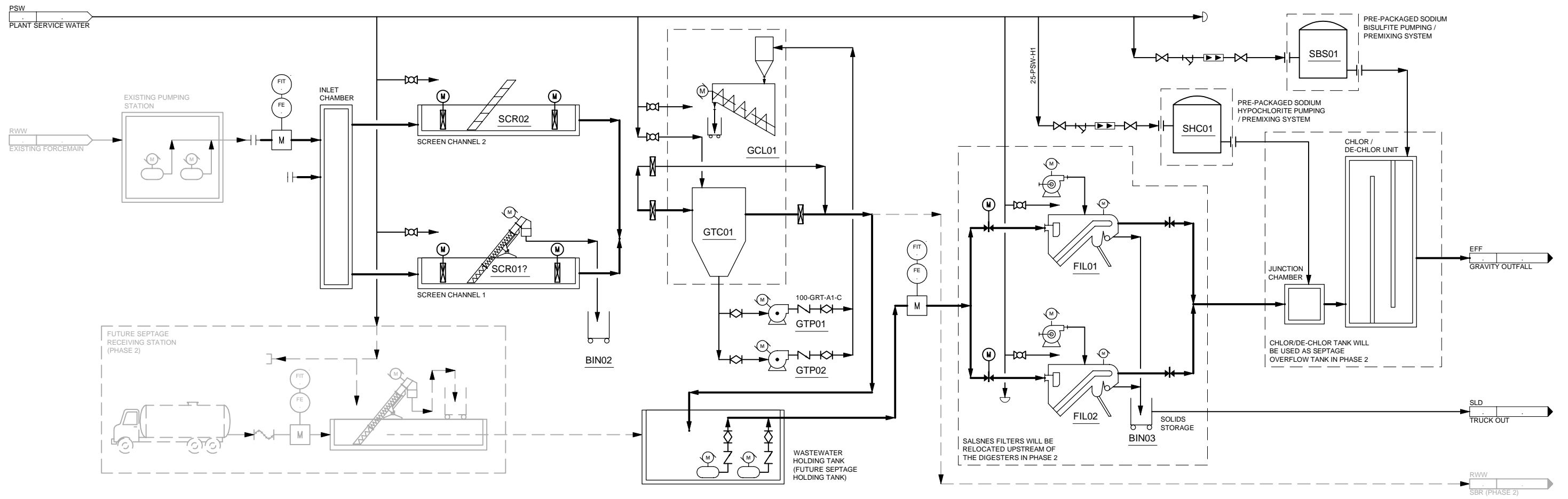

DRAWING  
REDUCED TO  
HALF SIZE

NO.	DATE	ENG.	BY	SUBJECT
REVISIONS				

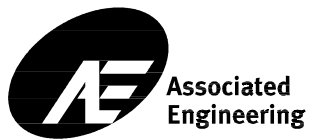

PROJECT No.	2013-4246
SCALE	NTS
DRAWN	K.Y.
DESIGNED	P.S.

**MANITOBA WATER SERVICES BOARD & TOWN OF VIRDEN**

PROCESS AND INSTRUMENTATION DIAGRAM

<b>VIRDEN WWTP UPGRADES</b>		
PHASE 1 - HEADWORKS		
DRAWING NUMBER	REV. NO.	SHEET
4246-00-401	A	1 / 3

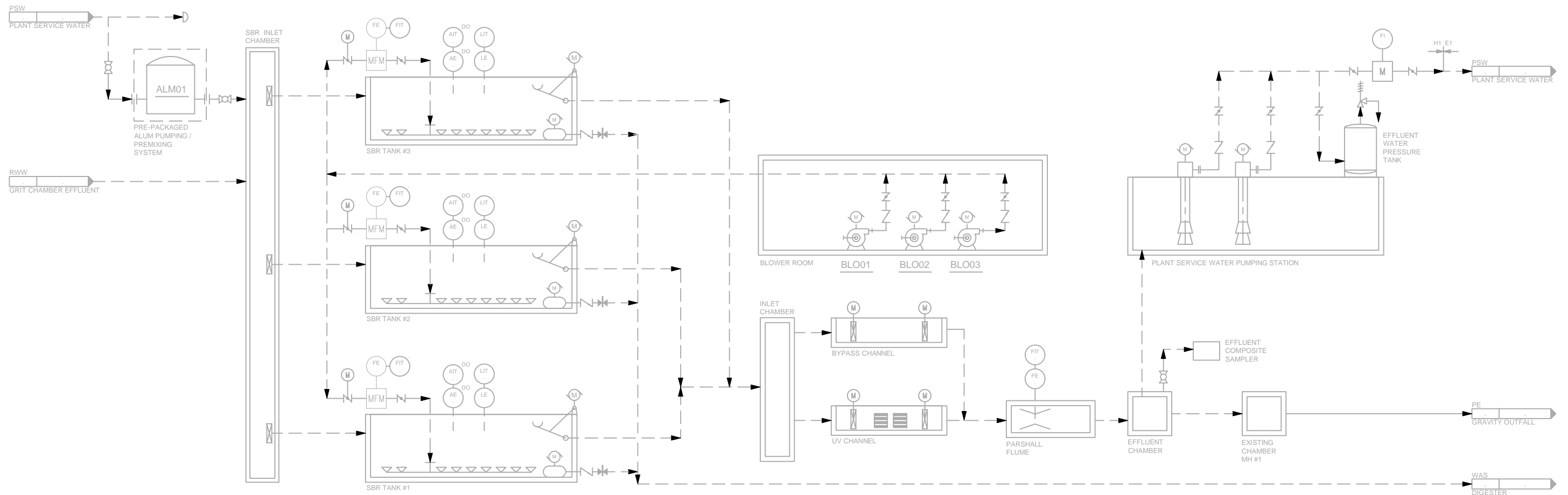

DRAWING  
REDUCED TO  
HALF SIZE

NO.	DATE	ENG.	BY	SUBJECT
REVISIONS				



PROJECT No.	2013-4246
SCALE	NTS
DRAWN	K.Y.
DESIGNED	P.S.

**MANITOBA WATER SERVICES BOARD & TOWN OF VIRDEN**

PROCESS AND INSTRUMENTATION DIAGRAM

<b>VIRDEN WWTP UPGRADES</b>		
PHASE 2 - SECONDARY TREATMENT		
DRAWING NUMBER	REV. NO.	SHEET
4246-00-402	A	2 / 3

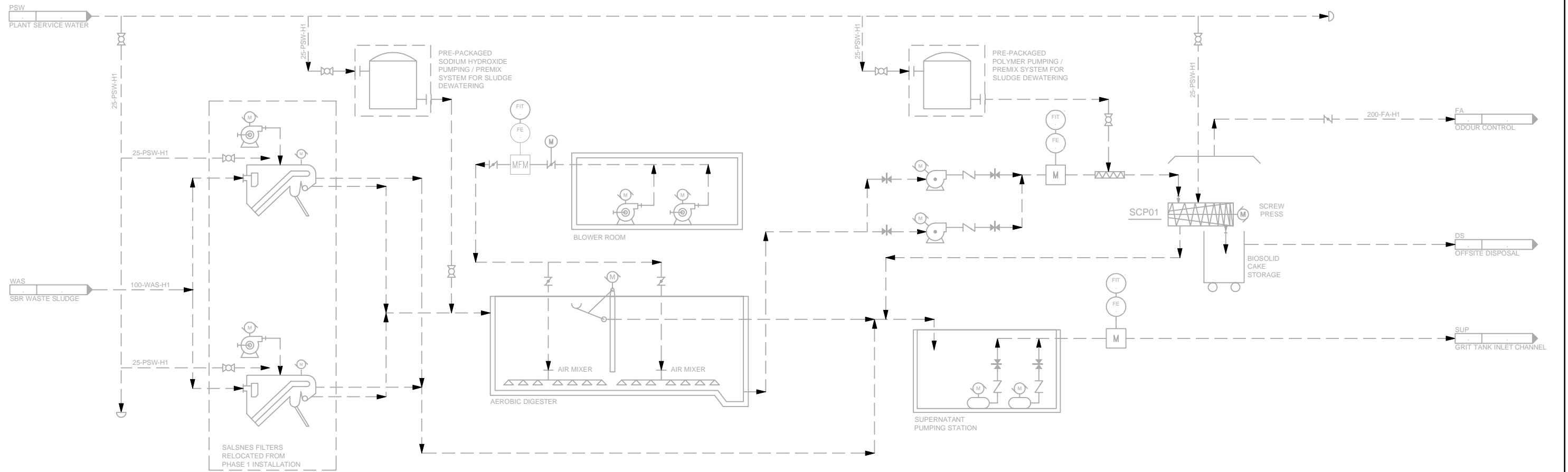

DRAWING  
REDUCED TO  
HALF SIZE

NO.	DATE	ENG.	BY	SUBJECT
REVISIONS				



PROJECT No.	2013-4246
SCALE	NTS
DRAWN	K.Y.
DESIGNED	P.S.

**MANITOBA WATER SERVICES BOARD & TOWN OF VIRDEN**

PROCESS  
PROCESS AND INSTRUMENTATION DIAGRAM

<b>VIRDEN WWTP UPGRADES</b>		
PHASE 2 - BIOSOLIDS TREATMENT		
DRAWING NUMBER	REV. NO.	SHEET
4246-00-403	A	3 / 3



This Drawing is For The Use Of The Client And Project Indicated  
No Representations Or Any Kind Are Made To Other Parties

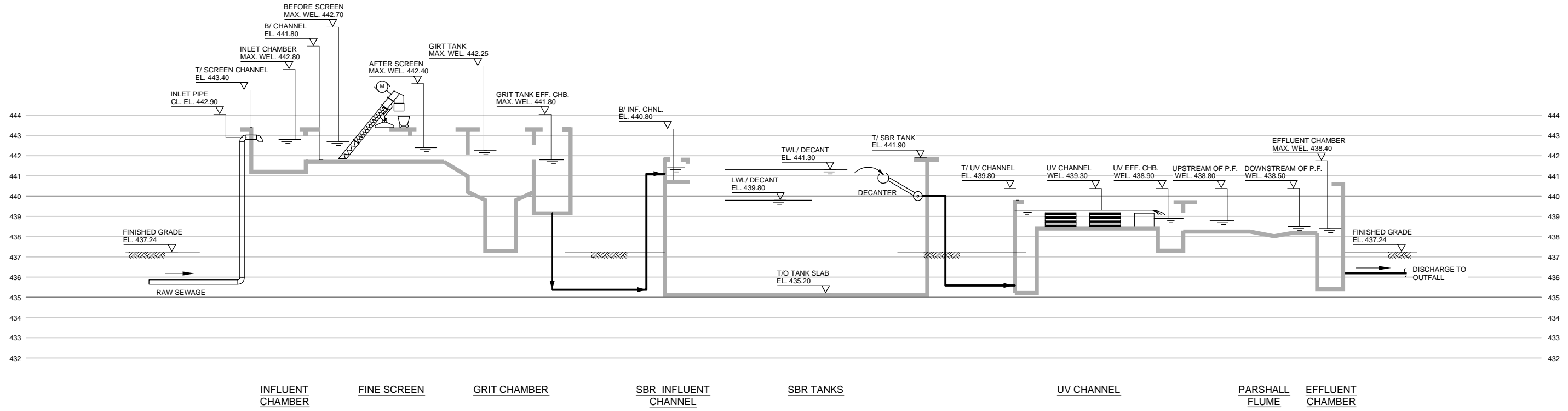

**PLANT HYDRAULIC PROFILE**

(Q\_Maximum Daily Flow = 1800 m<sup>3</sup>/d)  
(Q\_Maximum Hourly Flow = 3778 m<sup>3</sup>/d)  
(Q\_Peak Instantaneous Flow = 5625 m<sup>3</sup>/d)

\\s02\41-01\069\2013\2426\00\_T0V\_WWTP\_Upgrade\Work\eng\_Dwg\400\_Process\_Main\2426-00-404.dwg  
DATE: 2013-10-16, 10:56, Kevin Yu

NO.	DATE	ENG.	BY	SUBJECT
REVISIONS				



PROJECT No.	2013-20DT
SCALE	N.T.S.
DRAWN	
DESIGNED	

**MANITOBA WATER SERVICES BOARD & TOWN OF VIRDEN**

PROCESS HYDRAULIC PROFILE

<b>VIRDEN WWTP UPGRADES</b>		
DRAWING NUMBER	REV. NO.	SHEET
4246-00-404	A	1 / 1

---

**APPENDIX D**  
**PUBLIC CONSULTATION INFORMATION**

TOWN OF VIRDEN  
WASTE WATER TREATMENT FACILITY UPGRADE

OPEN HOUSE  
OCTOBER 23, 2013

NAME

CIVIC ADDRESS

EMAIL ADDRESS

PHONE NUMBER

David Klassen  
CARY GOODRIDGE  
JEFF O'DRISCOLL  
Stevan Bray  
JEFF MCCONNOR  
Maime Bhacum  
TINA Williams/Reny Kitto  
Rhonda Stewart  
Kevin ENNS  
Dunbar White  
Brett Cameron  
Ed BRETHOUR.  
Alex Renard  
Jesse Gray  
John Crocker  
ANNS DANJER  
TONY SCHNEIDER  
Ryan Mathieson





**Town of Virden Open House  
For the Proposed Wastewater Treatment Facility Upgrades**

**Tundra Oil & Gas Place - 900 Fifth Avenue South, Virden  
Wednesday, October 23, 2013 - 4:00 pm to 8:00 pm**

Where do you live?    Town of Virden     RM of Wallace     Other: \_\_\_\_\_

Please provide any comments or suggestions that you may have regarding the proposed Wastewater Treatment Facility (WWTF) Upgrade.

*I am so pleased to see something being done about this PROBLEM. To be a leader in wastewater treatment in today's environmentally aware society is truly a step in the right direction.*

What aspects of the WWTF Upgrades interest you the most?

*To make the water possible clean enough to re-introduce fish into Gopher Creek.*

Are there any potential aspects of the proposed WWTF Upgrades that you think we should be specifically addressing?

*The time frame, let's stick to it and make it happen!*

Would you like more information regarding the proposed WWTF Upgrades?    YES     NO

If YES, what additional information are you interested in concerning the proposed WWTF?

*Tours, Technology, Education.*

How would you like to be contacted:    Mail     Email     Phone

Please provide your contact information:

Name: \_\_\_\_\_  
Address: \_\_\_\_\_  
Postal Code: \_\_\_\_\_  
Email Address: \_\_\_\_\_

**Thank You for Your Valued Participation**

**Town of Virden Open House  
For the Proposed Wastewater Treatment Facility Upgrades**

**Tundra Oil & Gas Place - 900 Fifth Avenue South, Virden  
Wednesday, October 23, 2013 - 4:00 pm to 8:00 pm**

Where do you live?    Town of Virden     RM of Wallace     Other: \_\_\_\_\_

**Please provide any comments or suggestions that you may have regarding the proposed Wastewater Treatment Facility (WWTF) Upgrade.**

---

---

---

**What aspects of the WWTF Upgrades interest you the most?**

*Water Quality*

---

---

---

**Are there any potential aspects of the proposed WWTF Upgrades that you think we should be specifically addressing?**

*Securing financing*

---

---

---

**Would you like more information regarding the proposed WWTF Upgrades?**    YES     NO

If YES, what additional information are you interested in concerning the proposed WWTF?

*Progression updates*

---

---

How would you like to be contacted:    Mail     Email     Phone

Please print name and address in blue ink

Name: \_\_\_\_\_

Address: \_\_\_\_\_

Postal Code: \_\_\_\_\_

Email Address: \_\_\_\_\_

**Thank You for Your Valued Participation**

**Town of Virden Open House  
For the Proposed Wastewater Treatment Facility Upgrades**

**Tundra Oil & Gas Place - 900 Fifth Avenue South, Virden  
Wednesday, October 23, 2013 - 4:00 pm to 8:00 pm**

Where do you live?    Town of Virden     RM of Wallace     Other: \_\_\_\_\_

**Please provide any comments or suggestions that you may have regarding the proposed Wastewater Treatment Facility (WWTF) Upgrade.**

*over due -*

**What aspects of the WWTF Upgrades interest you the most?**

*Green - Repurposing waste*

**Are there any potential aspects of the proposed WWTF Upgrades that you think we should be specifically addressing?**

*\* Responsibility if prov. guidelines not meet \*  
"Performance Bond" on engineers etc.*

**Would you like more information regarding the proposed WWTF Upgrades?**    YES     NO

If YES, what additional information are you interested in concerning the proposed WWTF?

\_\_\_\_\_

How would you like to be contacted:    Mail     Email     Phone

Please provide your

Name: \_\_\_\_\_

Address: \_\_\_\_\_

Postal Code: \_\_\_\_\_

Email Address: \_\_\_\_\_

**Thank You for Your Valued Participation**

---

**APPENDIX E**  
**MANITOBA WATER WELL RECORDS**



LOCATION: 22-10-26W

Owner: S RUDNESKI  
Driller: FRED ZAVISLAK WELL DRILLING  
Well Name:  
Well Use: PRODUCTION  
Water Use: Domestic  
Date Completed: 1991 Jun 15

WELL LOG

From (ft.)	To (ft.)	Log
0	1.0	SANDY BLACK DIRT
1.0	7.0	FINE YELLOW SAND
7.0	10.0	COARSE YELLOW SAND, WATER BEARING
10.0	30.0	FINE BLUE SILTY CLAY
30.0	41.0	HARD BLUE CLAY

WELL CONSTRUCTION

From (ft.)	To (ft.)	Casing Type	Inside Dia.(in)	Outside Dia.(in)	Slot Size(in)	Type	Material
0	41.0	casing		30.00		CORRUGATED	GALVANIZED
0	0	gravel pack					WASHED S.

Top of Casing: 1.0 ft. below ground

PUMPING TEST

Date: 1991 Jun 15  
Pumping Rate: 3.0 Imp. gallons/minute  
Water level before pumping: ft. below ground  
Pumping level at end of test: ?? ft. below ground  
Test duration: hours, minutes  
Water temperature: ?? degrees F

REMARKS

430-11TH. AVE., VIRDEN

---

LOCATION: 22-10-26W

Owner: H CONQUERGOOD  
Driller: Paddock Drilling Ltd.  
Well Name:  
Well Use: PRODUCTION  
Water Use: Domestic  
Date Completed: 1984 Aug 23

WELL LOG

From (ft.)	To (ft.)	Log
0	18.0	SAND; MEDIUM FINE, BROWN
18.0	19.0	CLAY; SILTY, BROWN
19.0	30.0	CLAY; SILTY, GREY
30.0	35.0	TILL; ODD STONE, GREY
35.0	38.0	SAND; VERY FINE, CLEAN GREY
38.0	49.0	TILL; ODD STONE, GREY

WELL CONSTRUCTION

From (ft.)	To (ft.)	Casing Type	Inside Dia.(in)	Outside Dia.(in)	Slot Size(in)	Type	Material
0	49.0	casing	30.00			CORRUGATED	GALVANIZED
19.0	49.0	perforations				PERF. PIPE	
0	49.0	gravel pack					WASHED S.

Top of Casing: 1.0 ft. below ground

PUMPING TEST

Date: 1984 Aug 23  
Pumping Rate: 4.0 Imp. gallons/minute  
Water level before pumping: 17.0 ft. below ground  
Pumping level at end of test: ?? ft. below ground  
Test duration: 30 hours, minutes  
Water temperature: ?? degrees F

---

LOCATION: 22-10-26W

Owner: D SMITH  
Driller: Paddock Drilling Ltd.  
Well Name:  
Well Use: PRODUCTION  
Water Use: Domestic  
Date Completed: 1983 Mar 25

WELL LOG

From (ft.)	To (ft.)	Log
0	9.0	FINE BROWN SAND
9.0	11.0	FINE BROWN SAND, FAIRLY CLEAN
11.0	12.0	DIRTY BROWN SAND
12.0	13.0	SILTY BROWN CLAY
13.0	14.5	BROWN SAND AND GRAVEL, COARSE
14.5	17.0	SOFT BLUE TILL
17.0	27.0	FIRM TILL ODD COBBLE
27.0	28.0	SANDY TILL

WELL CONSTRUCTION

From (ft.)	To (ft.)	Casing Type	Inside Dia.(in)	Outside Dia.(in)	Slot Size(in)	Type	Material
0	28.0	casing	30.00			CORRUGATED	GALVANIZED
8.0	28.0	perforations				SAW CUT	
0	28.0	gravel pack					WASHED S.

Top of Casing: 2.0 ft. below ground

PUMPING TEST

Date: 1983 Mar 25  
Pumping Rate: 3.0 Imp. gallons/minute  
Water level before pumping: 10.0 ft. below ground  
Pumping level at end of test: 25.0 ft. below ground  
Test duration: 1 hours, minutes  
Water temperature: ?? degrees F

---

LOCATION: 22-10-26W

Owner: WARKENTIN BUILDING MOVERS  
Driller: Paddock Drilling Ltd.  
Well Name:  
Well Use: PRODUCTION  
Water Use: Domestic  
Date Completed: 1999 Aug 13

WELL LOG

From (ft.)	To (ft.)	Log
0	0.5	TOPSOIL
0.5	21.0	FINE BROWN SAND, SILTY 1-7 FEET
21.0	25.0	FINE GREY SAND
25.0	38.5	GREY TILL, SOFT, FIRMER WITH DEPTH, STONY, STOPPED BY BOULDER AT 38.5 FEET

WELL CONSTRUCTION

From (ft.)	To (ft.)	Casing Type	Inside Dia.(in)	Outside Dia.(in)	Slot Size(in)	Type	Material
0	18.0	CASING	30.00			CORRUGATED	FIBERGLASS
18.0	38.0	PERFORATIONS			0.040	SAW CUT	PVC
0	38.0	GRAVEL PACK					WASHED SAND

Top of Casing: 1.5 ft. above ground

PUMPING TEST

Date: 1999 Aug 13  
Pumping Rate: 15.0 Imp. gallons/minute  
Water level before pumping: 17.0 ft. below ground  
Pumping level at end of test: 33.0 ft. below ground  
Test duration: 1 hours, minutes  
Water temperature: ?? degrees F

REMARKS

PUMP TEST IS RECOVERY

---

LOCATION: 22-10-26W

Owner: GAS WORKS  
Driller: MANITOBA GOVERNMENT  
Well Name:  
Well Use: TEST WELL  
Water Use:  
Date Completed: 1910 Mar 12

WELL LOG

From (ft.)	To (ft.)	Log
0	50.0	CLAY
50.0	79.9	BOULDERS
79.9	122.9	CLAY AND SHALE
122.9	129.9	BOULDERS
129.9	267.8	CLAY
267.8	274.8	CLAY AND SHALE
274.8	279.8	HARD SHALE
279.8	288.8	CLAY AND SHALE
288.8	304.8	CLAY
304.8	322.8	CLAY AND SHALE
322.8	349.8	SHALE
349.8	372.8	CLAY AND SHALE

WELL CONSTRUCTION

From (ft.)	To (ft.)	Casing Type	Inside Dia.(in)	Outside Dia.(in)	Slot Size(in)	Type	Material
0	351.8	casing	4.50				

Top of Casing: ft. below ground

No pump test data for this well.

---

LOCATION: 22-10-26W

Owner: W STEWART  
Driller: Paddock Drilling Ltd.  
Well Name:  
Well Use: PRODUCTION  
Water Use: Domestic  
Date Completed: 1982 Aug 26

WELL LOG

From (ft.)	To (ft.)	Log
0	8.0	VERY FINE BROWN SAND
8.0	10.0	SILTY BROWN CLAY
10.0	13.5	MEDIUM BROWN SAND
13.5	14.0	BROWN TILL
14.0	29.0	BLUE TILL
29.0	34.0	BLUE TILL STRINGERS OF GREY SAND
34.0	34.5	BOULDER

WELL CONSTRUCTION

From (ft.)	To (ft.)	Casing Type	Inside Dia.(in)	Outside Dia.(in)	Slot Size(in)	Type	Material
0	33.0	casing	30.00			CORRUGATED	METAL
9.0	33.0	perforations				SAW CUT	
0	34.0	gravel pack					WASHED S.

Top of Casing: 1.0 ft. below ground

PUMPING TEST

Date: 1982 Aug 26  
Pumping Rate: 4.0 Imp. gallons/minute  
Water level before pumping: 8.0 ft. below ground  
Pumping level at end of test: 30.0 ft. below ground  
Test duration: 1 hours, minutes  
Water temperature: ?? degrees F

---

LOCATION: 22-10-26W

Owner: D MCSORLEY  
Driller: CLOVERLEAF DRILLING  
Well Name:  
Well Use: PRODUCTION  
Water Use: Domestic  
Date Completed: 1981 Aug 11

WELL LOG

From (ft.)	To (ft.)	Log
0	6.0	BROWN SILT
6.0	11.0	SILTY BROWN CLAY
11.0	12.0	MEDIUM BROWN SAND
12.0	21.0	BLUE TILL
21.0	23.0	FINE GREY SAND
23.0	33.0	BLUE TILL FIRM

WELL CONSTRUCTION

From (ft.)	To (ft.)	Casing Type	Inside Dia.(in)	Outside Dia.(in)	Slot Size(in)	Type	Material
0	22.0	casing	30.00			CORRUGATED	
22.0	23.0	perforations			0.018	WIRE WOUND	S. S.
23.0	33.0	casing	30.00			CORRUGATED	
0	22.0	gravel pack					WASHED S.
22.0	23.0	gravel pack				NO. 20-40	SILICA S.
23.0	33.0	gravel pack					WASHED S.

Top of Casing: 2.0 ft. below ground

PUMPING TEST

Date: 1981 Aug 11  
Pumping Rate: 5.0 Imp. gallons/minute  
Water level before pumping: 11.0 ft. below ground  
Pumping level at end of test: 29.0 ft. below ground  
Test duration: 1 hours, 25 minutes  
Water temperature: ?? degrees F

---

LOCATION: 22-10-26W

Owner: DEPT OF TRANSPORT  
Driller: International Water Supply  
Well Name:  
Well Use: PRODUCTION  
Water Use: Industrial  
Date Completed: 1940 Nov 01

WELL LOG

From (ft.)	To (ft.)	Log
0	1.0	CLAY
1.0	7.0	CLAY AND SAND
7.0	15.0	SAND AND GRAVEL
15.0	37.0	CLAY, BOULDERS
37.0	53.0	BLUE CLAY
53.0	62.0	CLAY, BOULDERS
62.0	63.0	LIMESTONE
63.0	65.0	BLUE SHALE
65.0	139.9	BLUE CLAY
139.9	151.9	COARSE GRAVEL, SAND
151.9	153.9	GRAVEL, SAND, CLAY
153.9	159.9	GRAVEL, COARSE SAND
159.9	162.9	BLUE CLAY, SHALE

WELL CONSTRUCTION

From (ft.)	To (ft.)	Casing Type	Inside Dia.(in)	Outside Dia.(in)	Slot Size(in)	Type	Material
0	139.9	casing	14.00				
139.9	149.9	perforations	8.00		0.080	WIRE WOUND	
0	0	gravel pack					

Top of Casing: ft. below ground

PUMPING TEST

Date: 1940 Nov 01  
Pumping Rate: 175.0 Imp. gallons/minute  
Water level before pumping: 41.0 ft. below ground  
Pumping level at end of test: 47.0 ft. below ground  
Test duration: 24 hours, minutes  
Water temperature: ?? degrees F

REMARKS

BLK 78, VIRDEN, NOW STANDBY WELL FOR TOWN OF VIRDEN, RISER ABOVE  
SCREEN SHUTTER PERFORATIONS, SWL APRIL 21,1941 77.5 FT, APRIL 22 77.5  
FT JUNE 2, 61.6 FT, TEST APRIL 22,1941, SWL=41.5 FT, PUMPED AT 110  
IGPM PUMPING LEVEL 67 FT, GUARANTEED 35-100 IGPM, LOG FROM SKETCH  
FROM IWS

---



LOCATION: 22-10-26W

Owner: NIXON BUILDERS  
Driller: Paddock Drilling Ltd.  
Well Name:  
Well Use: PRODUCTION  
Water Use: Domestic  
Date Completed: 1994 Sep 21

WELL LOG

From (ft.)	To (ft.)	Log
0	1.0	TOPSOIL
1.0	11.0	FINE BROWN SAND, ODD COARSE LAYER
11.0	16.0	FINE SILTY BROWN SAND
16.0	17.0	SILTY CLAY
17.0	22.0	MEDIUM BROWN SAND, VERY CLEAN
22.0	30.0	FIRM GREY TILL

WELL CONSTRUCTION

From (ft.)	To (ft.)	Casing Type	Inside Dia.(in)	Outside Dia.(in)	Slot Size(in)	Type	Material
0	10.0	casing	30.00			CORRUGATED	FIBERGLASS
10.0	28.0	perforations			0.040	SAW CUT	FIBERGLASS
0	28.0	gravel pack					WASHED S.

Top of Casing: 1.0 ft. below ground

PUMPING TEST

Date: 1994 Sep 21  
Pumping Rate: 42.0 Imp. gallons/minute  
Water level before pumping: 12.0 ft. below ground  
Pumping level at end of test: 25.0 ft. below ground  
Test duration: 1 hours, minutes  
Water temperature: ?? degrees F

REMARKS

CEMETARY RD, PUMP TEST IS RECOVERY

---

LOCATION: 22-10-26W

Owner: MANITOBA POWER COMM  
Driller: MANITOBA GOVERNMENT  
Well Name:  
Well Use: PRODUCTION  
Water Use: Domestic  
Date Completed: 1922 Apr 09

WELL LOG

From (ft.)	To (ft.)	Log
0	30.0	SANDY TILL
30.0	129.9	BLUE CLAY
129.9	144.9	SAND AND GRAVEL

No construction data for this well.

Top of Casing: ft. below ground

PUMPING TEST

Date:  
Pumping Rate: ?? Imp. gallons/minute  
Water level before pumping: 28.0 ft. below ground  
Pumping level at end of test: ?? ft. below ground  
Test duration: ??? hours, ?? minutes  
Water temperature: ?? degrees F

---

LOCATION: 22-10-26W

Owner: G TAIT  
Driller: SPRINGWATER DRILLING LTD.  
Well Name: 1  
Well Use: PRODUCTION  
Water Use: Domestic  
Date Completed: 1980 Jul 30

WELL LOG

From (ft.)	To (ft.)	Log
0	8.0	DRY YELLOW SAND AND CLAY
8.0	12.0	WATER BEARING SAND
12.0	27.0	BLUE CLAY

WELL CONSTRUCTION

From (ft.)	To (ft.)	Casing Type	Inside Dia.(in)	Outside Dia.(in)	Slot Size(in)	Type	Material
0	26.0	casing	30.00				CORRUGATED GALVANIZED
7.0	13.0	perforations			0.060	SL. PIPE	
0	26.0	gravel pack					

Top of Casing: ft. below ground

PUMPING TEST

Date: 1980 Jul 30  
Pumping Rate: 2.0 Imp. gallons/minute  
Water level before pumping: 8.0 ft. below ground  
Pumping level at end of test: 26.0 ft. below ground  
Test duration: 1 hours, minutes  
Water temperature: 41.000 degrees F

---

LOCATION: 22-10-26W

Owner: TOWN OF VIRDEN  
Driller: MANITOBA GOVERNMENT  
Well Name: GAS WORKS  
Well Use: PRODUCTION  
Water Use: Municipal  
Date Completed: 1910 Jan 01

WELL LOG

From (ft.)	To (ft.)	Log
0	20.0	CLAY
20.0	79.9	CLAY, STONES AND GRAVEL
79.9	89.9	QUICKSAND
89.9	357.8	SHALE, WATER AT 145 FEET

No construction data for this well.

Top of Casing: ft. below ground

PUMPING TEST

Date:  
Pumping Rate: Imp. gallons/minute  
Water level before pumping: 10.0 ft. below ground  
Pumping level at end of test: ?? ft. below ground  
Test duration: ??? hours, ?? minutes  
Water temperature: ?? degrees F

---

LOCATION: NE22-10-26W

Owner: J MAYBERRY  
Driller: BALDING, D.A.  
Well Name:  
Well Use: PRODUCTION  
Water Use: Domestic  
Date Completed: 1979 Sep 01

WELL LOG

From (ft.)	To (ft.)	Log
0	7.0	YELLOW SAND
7.0	20.0	BLUE SANDY CLAY

WELL CONSTRUCTION

From (ft.)	To (ft.)	Casing Type	Inside Dia.(in)	Outside Dia.(in)	Slot Size(in)	Type	Material
0	20.0	casing	30.00			20 GAUGE	GALVANIZED

Top of Casing: ft. below ground

PUMPING TEST

Date:  
Pumping Rate: 16.0 Imp. gallons/minute  
Water level before pumping: 7.0 ft. below ground  
Pumping level at end of test: ?? ft. below ground  
Test duration: hours, minutes  
Water temperature: ?? degrees F

---

LOCATION: NE22-10-26W

Owner: VIRDEN HOSPITAL  
Driller: SPRINGWATER DRILLING LTD.  
Well Name: 1  
Well Use: PRODUCTION  
Water Use: Domestic  
Date Completed: 1980 Jul 29

WELL LOG

From (ft.)	To (ft.)	Log
0	17.0	DRY YELLOW SAND
17.0	22.0	WATER BEARING SAND
22.0	34.0	BLUE SILT
34.0	50.0	BLUE CLAY

WELL CONSTRUCTION

From (ft.)	To (ft.)	Casing Type	Inside Dia.(in)	Outside Dia.(in)	Slot Size(in)	Type	Material
0	50.0	casing	30.00			CORRUGATED	GALVANIZED
15.0	25.0	perforations			0.060	SL. PIPE	
0	50.0	gravel pack					

Top of Casing: 2.0 ft. below ground

PUMPING TEST

Date: 1980 Jul 29  
Pumping Rate: 20.0 Imp. gallons/minute  
Water level before pumping: 17.0 ft. below ground  
Pumping level at end of test: 50.0 ft. below ground  
Test duration: 1 hours, minutes  
Water temperature: 41.000 degrees F

---

LOCATION: NW22-10-26W

Owner: JAYS INN & SUITES  
Driller: Paddock Drilling Ltd.  
Well Name:  
Well Use: PRODUCTION  
Water Use: Domestic  
Date Completed: 1998 Apr 30

WELL LOG

From (ft.)	To (ft.)	Log
0	13.0	MEDIUM BROWN SAND, CLEAN
13.0	14.5	MEDIUM GREY SAND, CLEAN
14.5	20.0	GREY TILL, BOULDERS 18-20 FEET

WELL CONSTRUCTION

From (ft.)	To (ft.)	Casing Type	Inside Dia.(in)	Outside Dia.(in)	Slot Size(in)	Type	Material
0	9.0	CASING	30.00			CORRUGATED	FIBERGLASS
9.0	19.0	PERFORATIONS			0.040	SAW CUT	FIBERGLASS
0	19.0	GRAVEL PACK					WASHED SAND

Top of Casing: 1.0 ft. above ground

PUMPING TEST

Date: 1998 Apr 30  
Pumping Rate: 40.0 Imp. gallons/minute  
Water level before pumping: 6.0 ft. below ground  
Pumping level at end of test: 15.0 ft. below ground  
Test duration: 1 hours, minutes  
Water temperature: ?? degrees F

REMARKS

OFF HWY #1, PUMP TEST IS RCOVERY

---

LOCATION: NW22-10-26W

Owner: K D WELL SERVICING  
Driller: WALKER WELL SERVICES  
Well Name:  
Well Use: PRODUCTION  
Water Use: Domestic, Industrial  
Date Completed: 1989 May 26

WELL LOG

From (ft.)	To (ft.)	Log
0	3.0	FILL GRAVEL
3.0	10.0	CLAY SAND
10.0	15.0	CLAY
15.0	20.0	SAND
20.0	25.0	CLAY
25.0	35.0	SAND
35.0	45.0	GRAVEL CLAY
45.0	94.9	CLAY
94.9	129.9	SAND

WELL CONSTRUCTION

From (ft.)	To (ft.)	Casing Type	Inside Dia.(in)	Outside Dia.(in)	Slot Size(in)	Type	Material
0	121.9	casing	4.90			INSERT	PVC
121.9	127.9	perforations	4.00		0.010	WIRE WOUND	S. S.

Top of Casing: 2.0 ft. below ground

PUMPING TEST

Date: 1989 May 27  
Pumping Rate: 8.0 Imp. gallons/minute  
Water level before pumping: 10.0 ft. below ground  
Pumping level at end of test: 12.0 ft. below ground  
Test duration: 2 hours, minutes  
Water temperature: 42.800 degrees F

REMARKS

403-7TH. AVE., VIRDEN

---



LOCATION: NW22-10-26W

Owner: DEPT OF TRANSPORT  
Driller: UNKNOWN DRILLER  
Well Name:  
Well Use: TEST WELL  
Water Use:  
Date Completed: 1940 Nov 01

WELL LOG

From (ft.)	To (ft.)	Log
0	2.0	TOPSOIL
2.0	7.0	YELLOW CLAY
7.0	10.0	GRAVEL
10.0	16.0	SOFT BLUE CLAY
16.0	65.0	BLUE CLAY
65.0	79.9	FINE GRAVEL, DRY
79.9	97.9	SAND AND GRAVEL, WATER

No construction data for this well.

Top of Casing: ft. below ground

PUMPING TEST

Date:  
Pumping Rate: ?? Imp. gallons/minute  
Water level before pumping: 10.0 ft. below ground  
Pumping level at end of test: ?? ft. below ground  
Test duration: ??? hours, ?? minutes  
Water temperature: ?? degrees F

REMARKS

NEAR INTERSECIION OF 5TH AVE + BOUNDRY OF SECTION 22, CHEMICAL  
ANALYSIS GROUND LEVEL ELEV EST 1425 FT

---

LOCATION: SE22-10-26W

Owner: W ANDERSON  
Driller: Paddock Drilling Ltd.  
Well Name:  
Well Use: PRODUCTION  
Water Use: Domestic  
Date Completed: 1995 Sep 19

WELL LOG

From (ft.)	To (ft.)	Log
0	1.0	TOPSOIL
1.0	9.5	SAND, fine-medium FINE, BROWN
9.5	21.0	SOFT, SILTY GREY CLAY
21.0	30.0	GREY TILL, FIRM, STONY 25-30 FEET

WELL CONSTRUCTION

From (ft.)	To (ft.)	Casing Type	Inside Dia.(in)	Outside Dia.(in)	Slot Size(in)	Type	Material
0	9.0	casing	30.00			CORRUGATED	FIBERGLASS
9.0	29.0	perforations			0.040	SAW CUT	FIBERGLASS
0	29.0	gravel pack					WASHED S.

Top of Casing: 1.0 ft. below ground

PUMPING TEST

Date: 1995 Sep 19  
Pumping Rate: 10.0 Imp. gallons/minute  
Water level before pumping: 7.0 ft. below ground  
Pumping level at end of test: 26.0 ft. below ground  
Test duration: 1 hours, minutes  
Water temperature: ?? degrees F

REMARKS

PUMP TEST IS RECOVERY

---

LOCATION: SE22-10-26W

Owner: TOWN OF VIRDEN  
Driller: International Water Supply  
Well Name: VIRDEN TH #1  
Well Use: TEST WELL  
Water Use:  
Date Completed: 1956 Nov 17

WELL LOG

From (ft.)	To (ft.)	Log
0	14.0	FINE SAND, SOME FINE GRAVEL
14.0	48.0	GREY CLAY, SANDY, STONY LAYERS
48.0	66.0	GREY CLAY, STONY, HARD
66.0	108.9	DARK GREY SHALE, BRITTLE, HARD
108.9	119.9	DARK GREY CLAY, 6 INCHES OF HARD BONDED GRAVEL AT 120 FEET
119.9	140.9	DARK GREY CLAY, HARD
140.9	141.9	BONDED GRAVEL
141.9	142.9	SHALE
142.9	143.9	BONDED GRAVEL
143.9	183.9	GREY CLAY, VERY HARD
183.9	193.9	BLACK SHALE, BRITTLE, 6 INCHES OF HARD PACKED GRAVEL AT 194 FEET
193.9	205.9	DARK GREY SHALE, HARD, SOLID ROCK AT 206 FEET

No construction data for this well.

Top of Casing: ft. below ground

No pump test data for this well.

REMARKS

LOT 2, BLK 94, PLAN 67, ASHBURTON ST, 40 FT FROM #2 PONDER OIL WELL

---

LOCATION: SE22-10-26W

Owner: TOWN OF VIRDEN  
Driller: International Water Supply  
Well Name: VIRDEN TH #3  
Well Use: TEST WELL  
Water Use:  
Date Completed: 1956 Nov 30

WELL LOG

From (ft.)	To (ft.)	Log
0	8.0	BROWN SAND
8.0	18.0	BROWN CLAY, STONY, SAND AND GRAVEL AT 18 FEET
18.0	55.0	GREY CLAY, STONY LAYERS, HARD
55.0	61.0	BLACK SHALE

No construction data for this well.

Top of Casing: ft. below ground

No pump test data for this well.

REMARKS

BLK 153, SEYMORE ST, VIRDEN

---

LOCATION: SW22-10-26W

Owner: O MOREAU  
Driller: Paddock Drilling Ltd.  
Well Name:  
Well Use: PRODUCTION  
Water Use: Domestic  
Date Completed: 1987 Aug 06

WELL LOG

From (ft.)	To (ft.)	Log
0	1.5	SANDY BROWN CLAY
1.5	5.5	VERY FINE BROWN SAND, BOULDERS
5.5	11.0	BROWN TILL, FIRM
11.0	17.0	GREY TILL
17.0	19.0	GREY SILT
19.0	24.0	FINE TO COARSE GREY SAND, POORLY SORTED
24.0	28.0	GREY TILL, FIRM

WELL CONSTRUCTION

From (ft.)	To (ft.)	Casing Type	Inside Dia.(in)	Outside Dia.(in)	Slot Size(in)	Type	Material
0	8.0	casing	30.00			CORRUGATED	FIBERGLASS
8.0	26.0	perforations	30.00		0.040	SAW CUT	FIBERGLASS
0	28.0	gravel pack					WASHED S.

Top of Casing: 1.0 ft. below ground

PUMPING TEST

Date: 1987 Aug 06  
Pumping Rate: 5.0 Imp. gallons/minute  
Water level before pumping: 5.0 ft. below ground  
Pumping level at end of test: 26.0 ft. below ground  
Test duration: 1 hours, minutes  
Water temperature: ?? degrees F

REMARKS

1 BLK W OF GOVT RD PUMP TEST IS RECOVERY

---

LOCATION: SW22-10-26W

Owner: MIKE MARTEL  
Driller: Paddock Drilling Ltd.  
Well Name:  
Well Use: PRODUCTION  
Water Use: Domestic  
Date Completed: 1998 Oct 30

WELL LOG

From (ft.)	To (ft.)	Log
0	0.5	TOPSOIL
0.5	4.0	SILTY SAND
4.0	12.0	VERY FINE SAND
12.0	17.0	FINE SAND MIXED WITH FINE GRAVEL, CLEAN
17.0	19.0	FINE SILTY SAND
19.0	23.0	COARSE BROWN SAND MIXED WITH GRAVEL
23.0	30.0	FIRM GREY TILL

WELL CONSTRUCTION

From (ft.)	To (ft.)	Casing Type	Inside Dia.(in)	Outside Dia.(in)	Slot Size(in)	Type	Material
0	9.0	CASING	30.00			CORRUGATED	FIBERGLASS
9.0	29.0	PERFORATIONS			0.040	SAW CUT	FIBERGLASS
0	29.0	GRAVEL PACK					WASHED SAND

Top of Casing: 1.0 ft. above ground

PUMPING TEST

Date: 1998 Oct 30  
Pumping Rate: 57.0 Imp. gallons/minute  
Water level before pumping: 13.0 ft. below ground  
Pumping level at end of test: 24.0 ft. below ground  
Test duration: 1 hours, minutes  
Water temperature: ?? degrees F

REMARKS

LOT 1 CEMETARY RD, PUMP TEST IS RECOVERY

---

LOCATION: SW22-10-26W

Owner: P MORSKY  
Driller: COSENS DRILLING LTD.  
Well Name:  
Well Use: TEST WELL  
Water Use:  
Date Completed: 1981 May 04

WELL LOG

From (ft.)	To (ft.)	Log
0	10.5	BROWN SAND
10.5	41.0	GREY TILL
41.0	44.0	FINE SAND
44.0	51.0	GREY TILL WITH SAND LAYERS
51.0	63.0	GREY TILL
63.0	99.9	ODANAH SHALE

No construction data for this well.

Top of Casing: ft. below ground

No pump test data for this well.

---

LOCATION: SW22-10-26W

Owner: R BARKLEY  
Driller: Paddock Drilling Ltd.  
Well Name:  
Well Use: PRODUCTION  
Water Use: Domestic  
Date Completed: 1994 Jul 19

WELL LOG

From (ft.)	To (ft.)	Log
0	1.0	ORGANIC TOPSOIL
1.0	2.0	SILTY CLAY
2.0	5.0	OXIDIZED SAND
5.0	7.0	SILTY CLAY
7.0	13.0	BROWN TILL
13.0	25.0	GREY TILL WITH BOULDERS
25.0	30.0	FINE GREY SAND

WELL CONSTRUCTION

From (ft.)	To (ft.)	Casing Type	Inside Dia.(in)	Outside Dia.(in)	Slot Size(in)	Type	Material
0	10.0	casing	30.00			CORRUGATED	FIBERGLASS
10.0	28.0	perforations			0.040	SAW CUT	FIBERGLASS
0	28.0	gravel pack					WASHED S.

Top of Casing: 1.5 ft. below ground

PUMPING TEST

Date: 1994 Jul 19  
Pumping Rate: 15.0 Imp. gallons/minute  
Water level before pumping: 12.0 ft. below ground  
Pumping level at end of test: 26.0 ft. below ground  
Test duration: 1 hours, minutes  
Water temperature: ?? degrees F

REMARKS

PUMP TEST IS RECOVERY

---



LOCATION: SW22-10-26W

Owner: TOWN OF VIRDEN  
Driller: International Water Supply  
Well Name: VIRDEN TH #4  
Well Use: TEST WELL  
Water Use:  
Date Completed: 1956 Dec 01

WELL LOG

From (ft.)	To (ft.)	Log
0	8.0	YELLOW CLAY
8.0	29.0	GREY CLAY, STONY LAYERS
29.0	30.0	HARD PACKED SAND
30.0	48.0	GREY CLAY, STONY, HARD
48.0	76.0	GREY CLAY, HARD, GRAVEL STREAKS
76.0	80.9	GREY SHALE, SOFT
80.9	85.9	BLACK SHALE

No construction data for this well.

Top of Casing: ft. below ground

No pump test data for this well.

REMARKS

BLK 170, CENTRE , LOT 11, VIRDEN

---

LOCATION: 23-10-26W

Owner: T MCLEAN  
Driller: COSENS, TOM G.  
Well Name:  
Well Use: TEST WELL  
Water Use:  
Date Completed: 1974 Jun 10

WELL LOG

From (ft.)	To (ft.)	Log
0	10.0	FINE SAND
10.0	18.0	BLUE CLAY
18.0	24.0	GRAVEL
24.0	81.9	BLUE CLAY
81.9	82.9	MED SAND
82.9	87.9	BLUE CLAY
87.9	89.9	MED SAND
89.9	125.9	BLUE CLAY WITH STREAKS OF SHALE
125.9	163.9	BROWN CLAY

No construction data for this well.

Top of Casing: ft. below ground

PUMPING TEST

Date:  
Flowing Rate: 0.5 Imp. gallons/minute  
Water level before pumping: ft. below ground  
Pumping level at end of test: ?? ft. below ground  
Test duration: 5 hours, minutes  
Water temperature: ?? degrees F

---

LOCATION: 23-10-26W

Owner: CHEVRON CANADA RES  
Driller: Paddock Drilling Ltd.  
Well Name: OFFICE WELL  
Well Use: PRODUCTION  
Water Use: Domestic  
Date Completed: 1993 Feb 03

WELL LOG

From (ft.)	To (ft.)	Log
0	1.0	GRAVEL, FILL, FROZEN
1.0	19.0	MEDIUM FINE BROWN SAND
19.0	30.0	SOFT SILTY GREY CLAY

WELL CONSTRUCTION

From (ft.)	To (ft.)	Casing Type	Inside Dia.(in)	Outside Dia.(in)	Slot Size(in)	Type	Material
0	8.0	casing	30.00			INSERT	PVC
8.0	28.0	perforations			0.040	SAW CUT	PVC
0	28.0	gravel pack					WASHED S.

Top of Casing: 2.0 ft. below ground

PUMPING TEST

Date: 1993 Feb 03  
Pumping Rate: 18.0 Imp. gallons/minute  
Water level before pumping: 14.0 ft. below ground  
Pumping level at end of test: ?? ft. below ground  
Test duration: 1 hours, minutes  
Water temperature: ?? degrees F

REMARKS

.5 MI E OF HWY #1 AT KOLARD RD, BAIL TEST IS RECOVERY

---

LOCATION: 23-10-26W

Owner: VIRDEN NURSING HOME  
Driller: Paddock Drilling Ltd.  
Well Name: WELL #1  
Well Use: PRODUCTION  
Water Use: Irrigation  
Date Completed: 1985 Nov 02

WELL LOG

From (ft.)	To (ft.)	Log
0	14.5	FINE MEDIUM- FINE BROWN SAND
14.5	16.0	GREY CLAY

WELL CONSTRUCTION

From (ft.)	To (ft.)	Casing Type	Inside Dia.(in)	Outside Dia.(in)	Slot Size(in)	Type	Material
0	12.0	casing	2.00	2.00		T & C	GALVANIZED
12.0	14.5	perforations	2.00	2.00	0.010	WIRE WOUND	S. S.

Top of Casing: ft. below ground

PUMPING TEST

Date: 1985 Nov 02  
Pumping Rate: 10.0 Imp. gallons/minute  
Water level before pumping: 9.0 ft. below ground  
Pumping level at end of test: ?? ft. below ground  
Test duration: hours, minutes  
Water temperature: ?? degrees F

REMARKS

BESIDE UDN. HOSPITAL

---

LOCATION: 23-10-26W

Owner: VIRDEN NURSING HOME  
Driller: Paddock Drilling Ltd.  
Well Name: WELL #2  
Well Use: PRODUCTION  
Water Use: Irrigation  
Date Completed: 1985 Nov 02

WELL LOG

From (ft.)	To (ft.)	Log
0	14.5	SAND; BROWN, FINE TO MEDIUM
14.5	16.0	CLAY; GREY

WELL CONSTRUCTION

From (ft.)	To (ft.)	Casing Type	Inside Dia.(in)	Outside Dia.(in)	Slot Size(in)	Type	Material
0	12.0	casing	2.00			T & C	GALVANIZED
12.0	14.5	perforations	2.00		0.010	WIRE WOUND	S. S.

Top of Casing: ft. below ground

PUMPING TEST

Date: 1985 Nov 02  
Pumping Rate: 10.0 Imp. gallons/minute  
Water level before pumping: 9.0 ft. below ground  
Pumping level at end of test: ?? ft. below ground  
Test duration: hours, minutes  
Water temperature: ?? degrees F

---

LOCATION: 23-10-26W

Owner: VIRDEN NURSING HOME  
Driller: Paddock Drilling Ltd.  
Well Name: WELL #3  
Well Use: PRODUCTION  
Water Use: Irrigation  
Date Completed: 1985 Nov 02

WELL LOG

From (ft.)	To (ft.)	Log
0	14.5	SAND; BROWN, FINE TO MEDIUM
14.5	16.0	CLAY; GREY

WELL CONSTRUCTION

From (ft.)	To (ft.)	Casing Type	Inside Dia.(in)	Outside Dia.(in)	Slot Size(in)	Type	Material
0	12.0	casing	2.00			T & C	GALVANIZED
12.0	14.5	perforations	2.00		0.010	WIRE WOUND	S. S.

Top of Casing: ft. below ground

PUMPING TEST

Date: 1985 Nov 02  
Pumping Rate: 10.0 Imp. gallons/minute  
Water level before pumping: 9.0 ft. below ground  
Pumping level at end of test: ?? ft. below ground  
Test duration: hours, minutes  
Water temperature: ?? degrees F

---

LOCATION: 23-10-26W

Owner: VIRDEN NURSING HOME  
Driller: Paddock Drilling Ltd.  
Well Name: WELL #4  
Well Use: PRODUCTION  
Water Use: Irrigation  
Date Completed: 1985 Nov 02

WELL LOG

From (ft.)	To (ft.)	Log
0	14.5	SAND; BROWN, FINE
14.5	15.0	CLAY

WELL CONSTRUCTION

From (ft.)	To (ft.)	Casing Type	Inside Dia.(in)	Outside Dia.(in)	Slot Size(in)	Type	Material
0	12.0	casing	2.00			T & C	GALVANIZED
12.0	14.5	perforations	2.00		0.010	WIRE WOUND	S. S.

Top of Casing: ft. below ground

PUMPING TEST

Date: 1985 Nov 02  
Pumping Rate: 5.0 Imp. gallons/minute  
Water level before pumping: 9.0 ft. below ground  
Pumping level at end of test: ?? ft. below ground  
Test duration: hours, minutes  
Water temperature: ?? degrees F

---

LOCATION: NE23-10-26W

Owner: TOWN OF VIRDEN  
Driller: International Water Supply  
Well Name: VIRDEN TH #2  
Well Use: TEST WELL  
Water Use:  
Date Completed: 1956 Nov 27

WELL LOG

From (ft.)	To (ft.)	Log
0	4.0	TOPSOIL AND YELLOW CLAY
4.0	8.0	MEDIUM GRAVEL
8.0	10.0	HEAVY BOULDERS
10.0	18.0	GREY CLAY, SANDY, HEAVY BOULDERS AT 18 FEET
18.0	32.0	GREY CLAY, GRITTY, STONY, HARD, BOULDERS
32.0	49.0	GREY CLAY, SANDY, SOFT, SAND LAYERS
49.0	65.0	MEDIUM GRAVEL
65.0	71.0	GREY CLAY, STONY, HARD

WELL CONSTRUCTION

From (ft.)	To (ft.)	Casing Type	Inside Dia.(in)	Outside Dia.(in)	Slot Size(in)	Type	Material
0	55.0	casing	3.00				
55.0	65.0	perforations					

Top of Casing: ft. below ground

PUMPING TEST

Date: 1956 Nov 27  
Pumping Rate: 8.0 Imp. gallons/minute  
Water level before pumping: 15.0 ft. below ground  
Pumping level at end of test: 36.0 ft. below ground  
Test duration: 8 hours, minutes  
Water temperature: ?? degrees F

REMARKS

.75 MI E OF TOWN OF RD ALLOW, PUMPED WITH AIR, PUMP TEST AVAILABLE

---



LOCATION: NW23-10-26W

Owner: D SEXSMITH  
Driller: COSENS, TOM G.  
Well Name:  
Well Use: PRODUCTION  
Water Use: Domestic,Livestock  
Date Completed: 1974 Jun 01

WELL LOG

From (ft.)	To (ft.)	Log
0	22.0	FINE SAND
22.0	25.0	BLUE CLAY
25.0	38.0	MED SAND
38.0	51.0	COARSE SAND
51.0	76.0	BLUE CLAY
76.0	89.9	MED SAND
89.9	104.9	BLUE CLAY

WELL CONSTRUCTION

From (ft.)	To (ft.)	Casing Type	Inside Dia.(in)	Outside Dia.(in)	Slot Size(in)	Type	Material
0	83.9	casing	4.00			WELDED	
79.9	88.9	gravel pack					
83.9	88.9	perforations			0.015	WIRE WOUND	S. S.

Top of Casing: ft. below ground

PUMPING TEST

Date:  
Pumping Rate: 50.0 Imp. gallons/minute  
Water level before pumping: 26.0 ft. below ground  
Pumping level at end of test: 67.0 ft. below ground  
Test duration: 10 hours, minutes  
Water temperature: ?? degrees F

---

LOCATION: NW23-10-26W

Owner: MWSB VIRDEN  
Driller: COSENS DRILLING LTD.  
Well Name: TH-3(88)  
Well Use: TEST WELL  
Water Use:  
Date Completed: 1988 Oct 26

WELL LOG

From (ft.)	To (ft.)	Log
0	6.0	CLAY
6.0	12.0	SAND AND GRAVEL
12.0	55.0	GREY TILL; BOULDERY
55.0	60.0	BOULDERS
60.0	110.9	CLAY; PURE, FIRM; GREY

No construction data for this well.

Top of Casing: ft. below ground

No pump test data for this well.

REMARKS

TOWN INVESTIGATION, N. SIDE OLD HWY. NO.1 + W. SIDE OF GOPHER CREEK

---

LOCATION: SE23-10-26W

Owner: R DILLABOUGH  
Driller: COSENS, TOM G.  
Well Name:  
Well Use: PRODUCTION  
Water Use: Industrial  
Date Completed: 1974 Jun 05

WELL LOG

From (ft.)	To (ft.)	Log
0	12.0	FINE SAND
12.0	53.0	BLUE CLAY
53.0	55.0	MED SAND
55.0	82.9	BLUE CLAY
82.9	96.9	MED GRAVEL
96.9	123.9	BROWN CLAY

WELL CONSTRUCTION

From (ft.)	To (ft.)	Casing Type	Inside Dia.(in)	Outside Dia.(in)	Slot Size(in)	Type	Material
0	90.9	casing	4.00			WELDED	
90.9	94.9	perforations			0.018	WIRE WOUND	S. S.

Top of Casing: ft. below ground

PUMPING TEST

Date:  
Pumping Rate: 60.0 Imp. gallons/minute  
Water level before pumping: 23.0 ft. below ground  
Pumping level at end of test: 70.0 ft. below ground  
Test duration: 6 hours, minutes  
Water temperature: ?? degrees F

---

LOCATION: SE23-10-26W

Owner: GARRY GARDINER  
Driller: Paddock Drilling Ltd.  
Well Name:  
Well Use: PRODUCTION  
Water Use: Domestic,Livestock  
Date Completed: 2004 Mar 01

WELL LOG

From (ft.)	To (ft.)	Log
0	0.5	SANDY TOPSOIL
0.5	3.0	FINE BROWN SAND
3.0	4.5	SILTY CLAY
4.5	10.0	FINE TO MEDIUM BROWN SAND
10.0	13.0	MEDIUM GREY SAND, CLEAN
13.0	20.0	VERY SOFT SILTY CLAY
20.0	30.0	STIFF GREY CLAY

WELL CONSTRUCTION

From (ft.)	To (ft.)	Casing Type	Inside Dia.(in)	Outside Dia.(in)	Slot Size(in)	Type	Material
0	269.0	CASING	30.00	30.00		WIRE WOUND	FIBERGLASS
9.0	29.0	PERFORATIONS			0.040	SAW CUT	
8.0	29.0	GRAVEL PACK					WASHED SAND
7.0	8.0	CASING GROUT					BENTONITE
0	7.0	GRAVEL PACK					WASHED SAND

Top of Casing: 1.0 ft. above ground

PUMPING TEST

Date: 2004 Mar 01  
Pumping Rate: 15.0 Imp. gallons/minute  
Water level before pumping: 6.5 ft. below ground  
Pumping level at end of test: 25.0 ft. below ground  
Test duration: ??? hours, ?? minutes  
Water temperature: ?? degrees F

---

LOCATION: SE23-10-26W

Owner: T MCLEAN  
Driller: CLOVERLEAF DRILLING  
Well Name:  
Well Use: PRODUCTION  
Water Use: Domestic  
Date Completed: 1981 Sep 08

WELL LOG

From (ft.)	To (ft.)	Log
0	6.5	SANDY BROWN CLAY
6.5	9.0	FINE BROWN SAND
9.0	10.0	GREYISH CLAY
10.0	11.0	MEDIUM GREYISH SAND DRY
11.0	14.0	MEDIUM SAND, UNOXIDIZED CLEAN
14.0	15.0	FINE GRAVEL, CLEAN
15.0	21.0	SOFT GREY CLAY
21.0	25.0	GREY TILL

WELL CONSTRUCTION

From (ft.)	To (ft.)	Casing Type	Inside Dia.(in)	Outside Dia.(in)	Slot Size(in)	Type	Material
0	14.0	casing	30.00			CORRUGATED	METAL
14.0	15.0	perforations	30.00		0.018	WIRE WOUND	GALVANIZED
15.0	25.0	casing	30.00			CORRUGATED	METAL
0	13.0	gravel pack					WASHED S.
13.0	16.0	gravel pack				NO. 20-40	SILICA S.
16.0	25.0	gravel pack					WASHED S.

Top of Casing: 2.0 ft. below ground

PUMPING TEST

Date: 1981 Sep 08  
Pumping Rate: 4.0 Imp. gallons/minute  
Water level before pumping: 11.0 ft. below ground  
Pumping level at end of test: 16.0 ft. below ground  
Test duration: 1 hours, minutes  
Water temperature: ?? degrees F

---

LOCATION: NW24-10-26W

Owner: D SEXSMITH  
Driller: CLOVERLEAF DRILLING  
Well Name:  
Well Use: PRODUCTION  
Water Use: Livestock  
Date Completed: 1981 Apr 30

WELL LOG

From (ft.)	To (ft.)	Log
0	4.0	MEDIUM BROWN SAND
4.0	5.0	MEDIUM BROWN SAND AND GRAVEL
5.0	17.0	MEDIUM TO COARSE BROWN SAND
17.0	22.0	FINE BROWN SAND CLEAN
22.0	23.0	FINE GREY SAND CLEAN
23.0	27.0	SILTY GREY CLAY

WELL CONSTRUCTION

From (ft.)	To (ft.)	Casing Type	Inside Dia.(in)	Outside Dia.(in)	Slot Size(in)	Type	Material
0	22.0	casing	30.00			CORRUGATED	METAL
22.0	23.0	perforations	30.00		0.018	WIRE WOUND	GALVANIZED
23.0	25.0	casing	30.00			CORRUGATED	METAL
0	21.0	gravel pack					WASHED S.
21.0	23.5	gravel pack				NO. 20-40	SILICA S.
23.5	27.0	gravel pack					WASHED S.

Top of Casing: 2.0 ft. below ground

PUMPING TEST

Date: 1981 Apr 30  
Pumping Rate: 20.0 Imp. gallons/minute  
Water level before pumping: 15.0 ft. below ground  
Pumping level at end of test: 20.0 ft. below ground  
Test duration: 1 hours, minutes  
Water temperature: ?? degrees F

---

LOCATION: SW24-10-26W

Owner: R COLEMAN  
Driller: BALDING, D.A.  
Well Name:  
Well Use: PRODUCTION  
Water Use: Livestock  
Date Completed: 1980 Aug 01

WELL LOG

From	To	Log
(ft.)	(ft.)	
0	22.0	SAND

WELL CONSTRUCTION

From	To	Casing	Inside	Outside	Slot	Type	Material
(ft.)	(ft.)	Type	Dia.(in)	Dia.(in)	Size(in)		
0	22.0	casing	30.00			CORRUGATED	GALVANIZED

Top of Casing: ft. below ground

PUMPING TEST

Date: 1980 Aug 01  
Pumping Rate: Imp. gallons/minute  
Water level before pumping: 17.0 ft. below ground  
Pumping level at end of test: 14.0 ft. below ground  
Test duration: 1 hours, minutes  
Water temperature: ?? degrees F

---

LOCATION: SW24-10-26W

Owner: RON COLEMAN  
Driller: Paddock Drilling Ltd.  
Well Name:  
Well Use: PRODUCTION  
Water Use: Domestic,Livestock  
Date Completed: 1997 Nov 05

WELL LOG

From (ft.)	To (ft.)	Log
0	0.5	SANDY TOPSOIL
0.5	12.0	FINE BROWN SAND
12.0	20.0	SILTY GREY CLAY

WELL CONSTRUCTION

From (ft.)	To (ft.)	Casing Type	Inside Dia.(in)	Outside Dia.(in)	Slot Size(in)	Type	Material
0	9.0	CASING	30.00			CORRUGATED	FIBERGLASS
9.0	19.0	PERFORATIONS			0.040	SAW CUT	FIBERGLASS
0	19.0	GRAVEL PACK					WASHED SAND

Top of Casing: 1.0 ft. above ground

PUMPING TEST

Date: 1997 Nov 05  
Pumping Rate: 12.0 Imp. gallons/minute  
Water level before pumping: 7.5 ft. below ground  
Pumping level at end of test: 16.0 ft. below ground  
Test duration: 1 hours, minutes  
Water temperature: ?? degrees F

REMARKS

PUMP TEST IS RECOVERY

---



LOCATION: SW24-10-26W

Owner: MWSB VIRDEN  
Driller: COSENS DRILLING LTD.  
Well Name: TH-1(88)  
Well Use: TEST WELL  
Water Use:  
Date Completed: 1988 Oct 05

WELL LOG

From (ft.)	To (ft.)	Log
0	8.0	fine-medium BROWN, SAND
8.0	43.0	GREY CLAY; SOFT, SILTY 20-25 FEET
43.0	49.0	TILL; GREY; STONE AT 48 FEET
49.0	52.5	GRAVEL AND BOULDERS
52.5	81.9	TILL; GREY HARD 60-70 FEET SMOOTH; FIRM 70.5-72 FEET DOLOMITE BOULDER 78-80 FEET ROUGH
81.9	84.9	CLAY
84.9	86.9	SAND
86.9	87.9	CLAY; GREY, FIRM
87.9	88.9	SAND
88.9	114.9	CLAY; GREY; SHALE LIKE
114.9	118.9	SAND AND SILT
118.9	126.9	CLAY; FIRM; SHALE LIKE
126.9	135.9	VERY FINE SAND AND SILT
135.9	139.9	CLAY
139.9	140.9	SILT
140.9	152.9	CLAY
152.9	161.9	FINE SAND
161.9	169.9	LAYERED CLAY AND SAND
169.9	173.9	SAND; FINE
173.9	175.4	CLAY
175.4	177.9	SAND
177.9	179.9	CLAY AND SAND
179.9	187.9	CLAY
187.9	191.4	FIRM
191.4	193.9	SHALY SAND
193.9	201.9	CLAY
201.9	209.9	FIRMER CLAY
209.9	213.4	SILT
213.4	219.9	FIRM TO HARD CLAY

WELL CONSTRUCTION

From (ft.)	To (ft.)	Casing Type	Inside Dia.(in)	Outside Dia.(in)	Slot Size(in)	Type	Material
0	151.9	casing	2.00			T & C	BLACK IRON
151.9	161.9	perforations	2.00			SL. PIPE	BLACK IRON

Top of Casing: ft. below ground

No pump test data for this well.

REMARKS

.28 KM. NORTH OF E-W RD. IN EAST DITCH, TOWN INVESTIGATION PUMPED ALL WATER OUT OF HOLE, THEN NOTHING CHECK WL - @ 110 AND RECOVERING SLOWLY - HOLE BLEW GAS QUITE STRONGLY - HOLE BACKFILLED W/SAND AND GRAVEL

---

LOCATION: SE25-10-26W

Owner: J FIEFCHAK  
Driller: Paddock Drilling Ltd.  
Well Name:  
Well Use: PRODUCTION  
Water Use: Domestic  
Date Completed: 1982 Nov 10

WELL LOG

From (ft.)	To (ft.)	Log
0	6.0	BROWN SAND AND FINE GRAVEL
6.0	13.0	MEDIUM BROWN SAND, CLEAN
13.0	15.0	FINE BROWN SAND, CLEAN
15.0	25.0	SILTY SOFT BLUE CLAY
25.0	29.0	TILL, SOFT, BLUE

WELL CONSTRUCTION

From (ft.)	To (ft.)	Casing Type	Inside Dia.(in)	Outside Dia.(in)	Slot Size(in)	Type	Material
0	29.0	casing	30.00			CORRUGATED	GALVANIZED
9.0	29.0	perforations				PERF. PIPE	
0	29.0	gravel pack					WASHED S.

Top of Casing: 1.0 ft. below ground

PUMPING TEST

Date: 1982 Nov 10  
Pumping Rate: 32.5 Imp. gallons/minute  
Water level before pumping: 9.0 ft. below ground  
Pumping level at end of test: 25.0 ft. below ground  
Test duration: 1 hours, minutes  
Water temperature: ?? degrees F

---

LOCATION: SE26-10-26W

Owner: WRB  
Driller: COSENS DRILLING LTD.  
Well Name: TH# V-15  
Well Use: TEST WELL  
Water Use:  
Date Completed: 1977 Sep 12

WELL LOG

From (ft.)	To (ft.)	Log
0	10.0	SAND-COARSE,OXIDIZED
10.0	28.0	SILT& CLAY-INTERBEDDED GREY,SOFT
28.0	51.0	TILL-SANDY,GRAVELLY
51.0	62.0	TILL-GREY FIRM SHALE BASE
62.0	77.0	SAND-FINE TO MED
77.0	151.9	CLAY, GREY INTERLAYERED WITH FINE SAND, SOME SILT
151.9	181.9	SHALE, GREY, SOFT, INTERLAYERED WITH DARK GREY, FIRM

WELL CONSTRUCTION

From (ft.)	To (ft.)	Casing Type	Inside Dia.(in)	Outside Dia.(in)	Slot Size(in)	Type	Material
0	64.0	casing	2.00			T & C	BLACK IRON
64.0	70.0	perforations	2.00		0.018	WIRE WOUND	GALVANIZED

Top of Casing: ft. below ground

PUMPING TEST

Date:  
Pumping Rate: 6.0 Imp. gallons/minute  
Water level before pumping: 13.0 ft. below ground  
Pumping level at end of test: 18.0 ft. below ground  
Test duration: 1 hours, 1 minutes  
Water temperature: ?? degrees F

REMARKS

VIRDEN GROUNDWATER AVAILABILITY STUDY, 30 FT N OF E/W RD, .6 MI E OF  
N/S RD, E-LOGGED, CHEMICAL ANALYSIS, EC=540 MM, NA<sub>2</sub>CO<sub>3</sub>=25 MG/L, H=7 GPG

---

LOCATION: SE26-10-26W

Owner: WRB  
Driller: COSENS DRILLING LTD.  
Well Name: TH# V-18  
Well Use: TEST WELL  
Water Use:  
Date Completed: 1977 Sep 13

WELL LOG

From (ft.)	To (ft.)	Log
0	5.0	SAND-MEDIUM,OXIDIZED
5.0	8.0	SILT-WHITE TO BEIGE
8.0	12.0	SAND& GRAVEL
12.0	40.0	TILL, GREY WITH GRAVEL LAYERS, FINE TO MEDIUM
40.0	46.0	CLAY
46.0	53.0	SAND-FINE GREY DIRTY
53.0	118.9	CLAY, SOFT, SANDY WITH SILT LAYERS FEW SAND LAYERS
118.9	123.9	SAND-FINE,DIRTY
123.9	141.9	CLAY, GREY, SOFT WITH THIN SAND LAYERS
141.9	143.9	SAND& CLAY LAYERS
143.9	145.9	CLAY-GREY
145.9	149.9	SAND-FINE
149.9	156.9	CLAY-GREY
156.9	173.9	SAND-FINE
173.9	182.9	SAND, COARSE WITH CLAY LAYERS
182.9	219.9	SHALE, LIGHT GREY AND DARK GREY, FIRM

No construction data for this well.

Top of Casing: ft. below ground

No pump test data for this well.

REMARKS

VIRDEN GROUNDWATER AVAILABILITY STUDY, 870 FT E OF V-15, NO TESTS,  
ROCK CAVED IN AT 45 FT

---

LOCATION: SW26-10-26W

Owner: MWSB VIRDEN  
Driller: COSENS DRILLING LTD.  
Well Name: TH-4(88)  
Well Use: TEST WELL  
Water Use:  
Date Completed: 1988 Oct 26

WELL LOG

From (ft.)	To (ft.)	Log
0	15.0	BROWN MEDIUM COARSE SAND
15.0	25.0	GREY CLAY; SILTY
25.0	51.0	GREY TILL; STONY 38-40 SAND AND GRAVEL 49 SAND LAYER
51.0	53.0	SAND; GRAVELLY
53.0	58.0	TILL; GREY, SOFT
58.0	59.5	TILL OR CLAY
59.5	60.0	GRAVEL
60.0	68.0	SAND
68.0	79.9	SAND; COARSER
79.9	94.9	COARSE SAND; SOME GRAVELLY
94.9	96.9	CEMENTED GRAVEL
96.9	99.9	FIRM GREY CLAY

WELL CONSTRUCTION

From (ft.)	To (ft.)	Casing Type	Inside Dia.(in)	Outside Dia.(in)	Slot Size(in)	Type	Material
0	84.9	casing	2.00			T & C	BLACK IRON
84.9	94.9	perforations	2.00			SL. PIPE	BLACK IRON

Top of Casing: ft. below ground

PUMPING TEST

Date: 1988 Oct 26  
Pumping Rate: 27.0 Imp. gallons/minute  
Water level before pumping: 20.0 ft. below ground  
Pumping level at end of test: ?? ft. below ground  
Test duration: 2 hours, minutes  
Water temperature: ?? degrees F

REMARKS

IN NORTH DITCH, S. SIDE HYDRO LINE RECOVERY T=5100 IGP/FT. EARLY, TO  
3600 TO 2400 EC=500 MMHOS - HARD=10 GPG - IRON= 0.5 MG/L

---

LOCATION: SE19-10-25W

Owner: P MURRAY  
Driller: Paddock Drilling Ltd.  
Well Name:  
Well Use: PRODUCTION  
Water Use: Domestic  
Date Completed: 1994 Jul 18

WELL LOG

From (ft.)	To (ft.)	Log
0	16.0	SAND, MEDIUM FINE, COARSE LAYERS
16.0	18.0	SAND, MEDIUM GREY AT 17 FEET
18.0	40.0	SILTY GREY CLAY

WELL CONSTRUCTION

From (ft.)	To (ft.)	Casing Type	Inside Dia.(in)	Outside Dia.(in)	Slot Size(in)	Type	Material
0	20.0	casing	30.00			CORRUGATED	FIBERGLASS
20.0	39.0	perforations			0.040	INSERT	FIBERGLASS
0	39.0	gravel pack					WASHED S.

Top of Casing: 1.0 ft. below ground

PUMPING TEST

Date: 1994 Jul 18  
Pumping Rate: 1.0 Imp. gallons/minute  
Water level before pumping: 16.0 ft. below ground  
Pumping level at end of test: 36.0 ft. below ground  
Test duration: 1 hours, 30 minutes  
Water temperature: ?? degrees F

REMARKS

PUMP TEST IS RECOVERY

---

LOCATION: SW19-10-25W

Owner: WRB  
Driller: Friesen Drillers Ltd.  
Well Name: G05MG015 OLA 97-1  
Well Use: OBSERVATION  
Water Use:  
Date Completed: 1997 Aug 21

WELL LOG

From (ft.)	To (ft.)	Log
0	19.0	SAND AND GRAVEL, BROWN
19.0	47.0	CLAY, GREY, SOFT
47.0	71.0	TILL, GREY, CLAYEY, ODD STONES
71.0	76.0	TILL, GREY, SOFT, LOTS OF STONES
76.0	80.0	SHALE, BLACK, HARD, LOOSING SOME WATER
80.0	83.0	SAND AND GRAVEL IN TILL
83.0	110.0	TILL, GREY, CLAYEY
110.0	123.0	TILL, GREY, DRY, CLAYEY
123.0	160.0	CLAY, GREY, VERY HARD, SMOOTH
160.0	191.0	SAND, CEMENTED, FINE, GREY, VERY SILTY
191.0	220.0	CLAY, VERY HARD, SMOOTH, GREY
220.0	269.0	CLAY, VERY HARD, SMOOTH, GREY
269.0	292.0	SAND AND LIGHT GRAVEL, GREY
292.0	300.0	CLAY, SOFT, GREY
300.0	307.0	SAND AND GRAVEL
307.0	336.0	SHALE AND LIMESTONE GRAVEL, BRITTLE
336.0	337.0	CLAY LAYER
337.0	345.0	SHALE AND LIMESTONE GRAVEL, LOOSING 6-10 IGPM
345.0	348.0	CLAY, HARD, GREY
348.0	373.0	CLAY AND GRAVEL LAYERS THROUGHOUT
373.0	377.0	CLAY AND GRAVEL MIX
377.0	380.0	SHALE GRAVEL, HARD, BLACK
380.0	383.0	CLAY, VERY HARD, GREY
383.0	386.0	POSSIBLE SHALE CONTACT
386.0	400.0	SHALE, VERY HARD, GREY, DRY

WELL CONSTRUCTION

From (ft.)	To (ft.)	Casing Type	Inside Dia.(in)	Outside Dia.(in)	Slot Size(in)	Type	Material
0	340.0	CASING	5.00			INSERT	BLACK IRON
340.0	345.0	PERFORATIONS	5.00		0.015	WIRE WOUND	S. S.

Top of Casing: 3.0 ft. above ground

No pump test data for this well.

REMARKS

35 FT E OF N/S RD & 100 FT N OF E/W RD, CHEMICAL ANALYSIS 1997

---



LOCATION: SW19-10-25W

Owner: WRB  
Driller: COSENS DRILLING LTD.  
Well Name: TH# V-11  
Well Use: TEST WELL  
Water Use:  
Date Completed: 1977 Nov 07

WELL LOG

From (ft.)	To (ft.)	Log
0	15.0	SAND&FINE GRAVEL-OXIDIZED SAND, MED TO COARSE
15.0	45.0	SILT, GREY, SOFT WITH CLAY LAYERS
45.0	66.0	TILL-GREY SANDY
66.0	106.9	TILL-GREY PEBBLY
106.9	163.9	SILT, DARK GREY WITH DARK GREY SILT LAYERS
163.9	165.9	SAND-CONSOLIDATED, GRITTY
165.9	170.9	SILT
170.9	177.9	SAND-VERY FINE
177.9	178.9	SILT
178.9	183.9	SAND
183.9	184.9	CLAY
184.9	191.9	SAND-FINE TO COARSE
191.9	218.9	CLAY, DARK GREY, FIRM
218.9	231.8	CLAY-GREY,HARD,FIRM
231.8	258.8	SILT, DARK GREY WITH HARD CLAY LAYERS
258.8	296.8	SAND, COARSE FINE GRAVEL, LIMESTONE, SHALE SILT LAYERS
296.8	322.8	SAND-COARSE,LESS SILTY THAN ABOVE
322.8	329.8	SAND-COARSE
329.8	331.8	LIMESTONE COBBLES
331.8	383.7	GRAVEL, MEDIUM, QUARTZ, IGNEOUS
383.7	386.7	SAND,FINE
386.7	399.7	GRAVEL AND COBBLES GRANITE BOULDER

WELL CONSTRUCTION

From (ft.)	To (ft.)	Casing Type	Inside Dia.(in)	Outside Dia.(in)	Slot Size(in)	Type	Material
0	345.8	casing	2.00			T & C	BLACK IRON
345.8	366.8	perforations	2.00				

Top of Casing: ft. below ground

PUMPING TEST

Date:  
Flowing Rate: Imp. gallons/minute  
Water level before pumping: ft. below ground  
Pumping level at end of test: ?? ft. below ground  
Test duration: 6 hours, 45 minutes  
Water temperature: ?? degrees F

REMARKS

VIRDEN GROUNDWATER AVAILABILITY STUDY, 37 FT E OF N/S RD, 175 FT N OF  
E/W RD, GAMMA RAY LOGGED, GAS ESCAPING UP TEST HOLE, CHEMICAL  
ANALYSIS EC=1150 MM, NACL=260 MG/L, H=6 GPG, FE=.8 MG/L, TESTED ZONE  
299-319 FT AT 2 IGPM FOR 84 MINS, CHEMICAL ANALYSIS

---

LOCATION: NW20-10-25W

Owner: MWSB/VIRDEN  
Driller: Ralph Edwards & Sons Drilling LTd.  
Well Name: TH.2  
Well Use: TEST WELL  
Water Use:  
Date Completed: 1992 Sep 24

WELL LOG

From (ft.)	To (ft.)	Log
0	6.0	BROWN CLAY
6.0	8.0	BLACK CLAY
8.0	15.0	GRAVEL AND SAND, OXIDIZED, SHALY, SHELLS
15.0	16.0	CLAY
16.0	17.0	FINE GRAVEL, UNOXIDIZED
17.0	32.0	CLAY, GREY
32.0	39.0	LAYERS CLAY AND SHALY GRAVEL
39.0	47.0	SOFT CLAY
47.0	50.0	FINE SHALY SAND
50.0	59.0	CLAY, SOFT, GREY
59.0	60.0	GRAVEL
60.0	61.0	CLAY
61.0	63.0	SAND
63.0	84.9	CLAY WITH LAYERS OF SAND
84.9	93.9	CLAY, FIRMER
93.9	101.9	SHALE GRAVEL, CLAY LAYERS
101.9	109.9	CLAY
109.9	113.9	CLAY AND SAND
113.9	116.9	SAND
116.9	140.9	CLAY, SOFT, SOME SAND AND GRAVEL LAYERS
140.9	141.9	SAND AND SILT
141.9	142.9	BOULDERS
142.9	150.9	SHALE, FIRM GREY CLAY

WELL CONSTRUCTION

From (ft.)	To (ft.)	Casing Type	Inside Dia.(in)	Outside Dia.(in)	Slot Size(in)	Type	Material
0	92.9	casing	2.00			INSERT	BLACK IRON
92.9	103.9	perforations	2.00			INSERT	BLACK IRON

Top of Casing: ft. below ground

PUMPING TEST

Date: 1992 Sep 24  
Pumping Rate: 1.5 Imp. gallons/minute  
Water level before pumping: ft. below ground  
Pumping level at end of test: ?? ft. below ground  
Test duration: hours, minutes  
Water temperature: ?? degrees F

REMARKS

IN S.E.CORNER OF 1/4. EC=1900+,HARD=9,FE=HIGH [MURHY].

---

LOCATION: NW20-10-25W

Owner: MWSB/VIRDEN  
Driller: Ralph Edwards & Sons Drilling LTd.  
Well Name: TH.3  
Well Use: TEST WELL  
Water Use:  
Date Completed: 1992 Sep 24

WELL LOG

From (ft.)	To (ft.)	Log
0	15.0	BROWN CLAY
15.0	25.0	GREY CLAY
25.0	35.0	DIRTY SHALY SAND
35.0	60.0	CLAY WITH FINE SAND OR SILT LAYERS
60.0	67.0	SHALE GRAVEL
67.0	70.0	BOULDERS AND GRAVEL
70.0	72.0	SAND OR CLAY
72.0	75.0	BOULDERS AND GRAVEL
75.0	77.9	SMOOTH CLAY
77.9	94.9	STONY GRAVEL, ROUGH, SEEMS LIKE STRATIFIED TILL, GRAVEL IS SHARP

WELL CONSTRUCTION

From (ft.)	To (ft.)	Casing Type	Inside Dia.(in)	Outside Dia.(in)	Slot Size(in)	Type	Material
0	60.0	casing	2.00			INSERT	BLACK IRON
60.0	71.0	perforations	2.00			SL. PIPE	BLACK IRON

Top of Casing: ft. below ground

PUMPING TEST

Date: 1992 Sep 24  
Pumping Rate: 55.0 Imp. gallons/minute  
Water level before pumping: 11.0 ft. below ground  
Pumping level at end of test: ?? ft. below ground  
Test duration: 2 hours, 50 minutes  
Water temperature: ?? degrees F

REMARKS

1100FT.W.OF CORNER OF ROAD AND 1000FT.W.OF TH.2, ON E-W.1/2 LINE.  
EC=900,HARD=14,FE=4.7,NACL=137,MN=NIL,SLIGHT H2S ODOUR, RECOVERY  
T=77,000IGPD/FT.EARLY, 66,000IGPD/FT.LATE. CHEMICAL ANALYSIS 1992.  
COULDN,T GET TEST PIPE PAST 72FT.

---

LOCATION: SE20-10-25W

Owner: MWSB/VIRDEN  
Driller: Ralph Edwards & Sons Drilling LTd.  
Well Name: TH.1  
Well Use: TEST WELL  
Water Use:  
Date Completed: 1992 Sep 24

WELL LOG

From (ft.)	To (ft.)	Log
0	9.0	CLAY
9.0	14.0	SAND, COARSE, SHALY
14.0	15.0	CLAY
15.0	16.0	SAND, FINE TO COARSE
16.0	19.0	CLAY AND SAND LAYERS
19.0	55.0	GREY CLAY
55.0	60.0	BROWN GREY CLAY
60.0	70.0	CLAY AND SHALY SAND
70.0	159.9	GREY CLAY, VERY SOFT

No construction data for this well.

Top of Casing: ft. below ground

No pump test data for this well.

REMARKS

S.SIDE E-W.RD.ALLOW.CURVE AND N.W.SIDE RIVER. NO TESTS.

---

LOCATION: SE20-10-25W

Owner: TOWN OF VIRDEN  
Driller: International Water Supply  
Well Name: VIRDEN TH #5  
Well Use: TEST WELL  
Water Use:  
Date Completed: 1956 Dec 03

WELL LOG

From (ft.)	To (ft.)	Log
0	18.0	SILTY BROWN CLAY
18.0	24.0	GREY CLAY
24.0	25.0	GRAVEL, SHALE CHIPS, VEGETATION, SILT
25.0	66.0	GREY CLAY
66.0	100.9	GREY, GREEN SHALE, SOFT

No construction data for this well.

Top of Casing: ft. below ground

No pump test data for this well.

REMARKS

LANGELOISE FARM ON RD ALLOWANCE, GROUND LEVEL ELEV EST 1225 FT

---

LOCATION: SW20-10-25W

Owner: MWSB/VIRDEN  
Driller: Ralph Edwards & Sons Drilling LTd.  
Well Name: TH.7  
Well Use: TEST WELL  
Water Use:  
Date Completed: 1992 Sep 30

WELL LOG

From (ft.)	To (ft.)	Log
0	15.0	BROWN CLAY
15.0	19.0	SAND, MEDIUM TO COARSE, NICE STUFF
19.0	21.0	CLAY
21.0	23.0	SILT AND SAND
23.0	29.0	FINE SAND
29.0	35.0	CLAY,GREY, SANDY
35.0	37.0	SAND AND FINE GRAVEL
37.0	52.0	CLAY WITH SHALE FRAGMENTS
52.0	59.0	GRAVEL, NICE STUFF
59.0	62.0	BOULDERS

WELL CONSTRUCTION

From (ft.)	To (ft.)	Casing Type	Inside Dia.(in)	Outside Dia.(in)	Slot Size(in)	Type	Material
0	49.0	casing	2.00			INSERT	BLACK IRON
49.0	61.0	perforations	2.00			INSERT	BLACK IRON

Top of Casing: ft. below ground

PUMPING TEST

Date: 1992 Sep 30  
Pumping Rate: 43.0 Imp. gallons/minute  
Water level before pumping: 11.0 ft. below ground  
Pumping level at end of test: ?? ft. below ground  
Test duration: hours, 20 minutes  
Water temperature: ?? degrees F

REMARKS

JUST OFF MOUTH GOPHER CREEK. EC=800, HARD=27, FE=4.5, MN=1.2,  
NACL=150, WHITE COLOUR. PUMPED WITH SUCTION PUMP, CHEMICAL ANALYSIS  
1992.

---



LOCATION: SW20-10-25W

Owner: TOWN OF VIRDEN  
Driller: International Water Supply  
Well Name: VIRDEN TH #6  
Well Use: TEST WELL  
Water Use:  
Date Completed: 1956 Dec 05

WELL LOG

From (ft.)	To (ft.)	Log
0	14.0	BROWN CLAY
14.0	24.0	GREY CLAY
24.0	27.0	SILT, SAND, VEGETATION
27.0	34.0	GREY CLAY
34.0	36.0	HARD SHALE, SAND LAYERS
36.0	51.0	GREY CLAY, SOFT, SANDY
51.0	79.9	GREY, GREEN SHALE, SOFT

No construction data for this well.

Top of Casing: ft. below ground

No pump test data for this well.

REMARKS

LANGE LOISE FARM, NE CORNER, GROUND LEVEL ELEV EST 1225 FT

---

LOCATION: NE30-10-25W

Owner: MWSB/VIRDEN  
Driller: Ralph Edwards & Sons Drilling LTd.  
Well Name: TH.4  
Well Use: TEST WELL  
Water Use:  
Date Completed: 1992 Sep 25

WELL LOG

From (ft.)	To (ft.)	Log
0	17.0	SHALY CLAY, OXIDIZED
17.0	20.0	SHALE RUBBLE, CLAYEY, GREY
20.0	53.0	CLAY, SOFT, GREY
53.0	70.0	CLAY, FIRMER, PURE
70.0	75.0	SHALE, SOFT

No construction data for this well.

Top of Casing: ft. below ground

No pump test data for this well.

REMARKS

AT OLD C.P.R.PUMPHOUSE SITE.

---

---

**APPENDIX F**  
**MANITOBA CONSERVATION DATA CENTRE**  
**SPECIES OF CONSERVATION CONCERN**

**Subject:** RE: Virden WWTP Upgrade EAP  
**From:** "Friesen, Chris (CWS)" <Chris.Friesen@gov.mb.ca>  
**Date:** 04/10/2013 1:59 PM  
**To:** "david.klassen@mts.net" <david.klassen@mts.net>

David

Please ignore my initial email below. Here's the correct response:

I completed a search of the Manitoba Conservation Data Centre database for your area of interest and found one occurrence on NW 19-10-25:

Great-blue Heron (*Ardea herodias*), S4S5 (rookery)

Further information on this ranking system can be found on our website at <http://www.gov.mb.ca/conservation/cdc/consranks.html>.

The information provided in this letter is based on existing data known to the Manitoba Conservation Data Centre of the Wildlife and Ecosystem Protection Branch at the time of the request. These data are dependent on the research and observations of our scientists and reflects our current state of knowledge. An absence of data does not confirm the absence of any rare or endangered species. Many areas of the province have never been thoroughly surveyed, therefore, the absence of data in any particular geographic area does not necessarily mean that species or ecological communities of concern are not present. The information should not be regarded as a final statement on the occurrence of any species of concern, nor should it substitute for on-site surveys for species or environmental assessments. Also, because our Biotics database is continually updated and because information requests are evaluated by type of action, any given response is only appropriate for its respective request.

Please contact the Manitoba CDC for an update on this natural heritage information if more than six months passes before it is utilized.

Third party requests for products wholly or partially derived from our Biotics database must be approved by the Manitoba CDC before information is released. Once approved, the primary user will identify the Manitoba CDC as data contributors on any map or publication using data from our database, as the Manitoba Conservation Data Centre; Wildlife and Ecosystem Protection Branch, Manitoba Conservation.

This letter is for information purposes only - it does not constitute consent or approval of the proposed project or activity, nor does it negate the need for any permits or approvals required by the Province of Manitoba.

We would be interested in receiving a copy of the results of any field surveys that you may undertake, to update our database with the most current knowledge of the area.

If you have any questions or require further information contact me directly at (204) 945-7747.

Chris Friesen  
Biodiversity Information Manager  
Manitoba Conservation Data Centre  
204-945-7747  
[chris.friesen@gov.mb.ca](mailto:chris.friesen@gov.mb.ca)  
<http://www.gov.mb.ca/conservation/cdc/>

-----Original Message-----  
From: Friesen, Chris (CWS)  
Sent: October-04-13 1:53 PM

To: 'david.klassen@mts.net'  
Subject: Virden WWTP Upgrade EAP

David

Thank you for your information request. I completed a search of the Manitoba Conservation Data Centre's rare species database and found no occurrences at this time for your area of interest.

The information provided in this letter is based on existing data known to the Manitoba Conservation Data Centre at the time of the request. These data are dependent on the research and observations of CDC staff and others who have shared their data, and reflect our current state of knowledge. An absence of data in any particular geographic area does not necessarily mean that species or ecological communities of concern are not present; in many areas, comprehensive surveys have never been completed. Therefore, this information should be regarded neither as a final statement on the occurrence of any species of concern, nor as a substitute for on-site surveys for species as part of environmental assessments.

Because the Manitoba CDC's Biotics database is continually updated and because information requests are evaluated by type of action, any given response is only appropriate for its respective request. Please contact the Manitoba CDC for an update on this natural heritage information if more than six months pass before it is utilized.

Third party requests for products wholly or partially derived from Biotics must be approved by the Manitoba CDC before information is released. Once approved, the primary user will identify the Manitoba CDC as data contributors on any map or publication using Biotics data, as follows as: Data developed by the Manitoba Conservation Data Centre; Wildlife and Ecosystem Protection Branch, Manitoba Conservation.

This letter is for information purposes only - it does not constitute consent or approval of the proposed project or activity, nor does it negate the need for any permits or approvals required by the Province of Manitoba.

We would be interested in receiving a copy of the results of any field surveys that you may undertake, to update our database with the most current knowledge of the area.

If you have any questions or require further information please contact me directly at (204) 945- 7747.

Chris Friesen  
Biodiversity Information Manager  
Manitoba Conservation Data Centre  
204-945-7747  
[chris.friesen@gov.mb.ca](mailto:chris.friesen@gov.mb.ca)  
<http://www.gov.mb.ca/conservation/cdc/>

-----Original Message-----

From:  
Sent: September-19-13 11:28 AM  
To: Friesen, Chris (CWS)  
Subject: WWW Form Submission

Below is the result of your feedback form. It was submitted by WWW Information Request () on Thursday, September 19, 2013 at 11:27:38

-----  
DocumentID: Manitoba\_Conservation

Project Title: Virden WWTP Upgrade EAP

Date Needed: 2013/10/04

Name: David Klassen

Company/Organization: EGE Engineering Ltd.

Address: 511 Pepperloaf Crescent

City: Winnipeg

Province/State: Manitoba

Phone: 204-612-0944

Email: [david.klassen@mts.net](mailto:david.klassen@mts.net)

Project Description: Environment Act Proposal for a project to upgrade the Virden Wastewater Treatment Plant.

Information Requested: List of plant and animal species and their conservation ranks.

Format Requested: Microsoft Word document

Location: Virden WWTP is in 22-10-26-W1M in the Town of Virden between Ashburton and Kent Streets north of 5th Avenue.

Effluent from the WWTP is discharged to Gopher Creek, which flows into Assiniboine River.

Gopher Creek downstream of WWTP is in:

23-10-26

24-10-26

25-10-26

26-10-26

19-10-25

20-10-25

Please include all of the above section/township/ranges in the database search.

action: Submit

-----

Government

Business

Residents

Tourism

Services

Search...

GO

Manitoba 

Manitoba Conservation Data Centre

Printer Friendly

Conservation &gt; Wildlife and Ecosystem Protection Branch &gt; Manitoba Conservation Data Centre

## Occurrence of Species by Ecoregion

[Return to Map](#)

### Apen Parkland

2013-01-13

Animal Assemblage			
Gull Colony		GNR	SNR
Snake Hibernaculum		GNR	SNR
Invertebrate Animal			
Copablepharon grande	Pale Yellow Dune Moth	G4G5	S1
Copablepharon longipenne	Dusky Dune Moth	G4	S1
Erynnis martialis	Mottled Dusky Wing	G3	S2
Hesperia dacotae	Dakota Skipper	G2	S2
Hesperia ottoe	Ottoe Skipper	G3G4	S1
Hypochlora alba	Sage Grasshopper	G5	SNR
Quadrula quadrula	Mapleleaf Mussel	G5	S2
Schinia avemensis	Golden-edged Gem	G1G3	S1
Schinia bimatrix	White Flower Moth	G2G4	S1
Strophitus undulatus	Creeper	G5	SNR
Vascular Plant			
Achnatherum hymenoides	Indian Rice Grass	G5	S2
Agalinis aspera	Rough Purple False-foxglove	G5	S1S2
Alisma gramineum	Narrow-leaved Water-plantain	G5	S1
Ambrosia acanthicarpa	Sandbur	G5	S1S2
Andropogon hallii	Sand Bluestem	G4	S2S3
Aristida purpurea var. longiseta	Red Three-awn	G5T5?	S1
Arnica fulgens	Shining Arnica	G5	S2
Artemisia cana	Silver Sagebrush	G5	S2
Asarum canadense	Wild Ginger	G5	S3S4
Asclepias lanuginosa	Hairy Milkweed	G4?	S2
Asclepias verticillata	Whorled Milkweed	G5	S3
Asclepias viridiflora	Green Milkweed	G5	S3
Astragalus gilviflorus	Cushion Milkvetch	G5	S1
Astragalus pectinatus	Narrow-leaved Milkvetch	G5	S2S3
Atriplex argentea	Saltbrush	G5	S2
Bidens amplissima	Beggar-ticks	G3	SNA
Boltonia asteroides var. recognita	White Boltonia	G5T3T5	S2S3
Botrychium campestre	Prairie Moonwort	G3G4	S1
Botrychium multifidum	Leathery Grape-fern	G5	S3
Bouteloua curtipendula	Side-oats Grama	G5	S2S3
Bromus porteri	Porter's Chess	G5	S3?
Bromus pubescens	Canada Brome Grass	G5	SNA
Buchloe dactyloides	Buffalograss	G4G5	S1
Calamagrostis montanensis	Plains Reed Grass	G5	S3
Callitriche heterophylla	Larger Water-starwort	G5	S2

<i>Carex bicknellii</i>	Bicknell's Sedge	G5	SH
<i>Carex cristatella</i>	Crested Sedge	G5	S2
<i>Carex cryptolepis</i>	Northeastern Sedge	G4	S1
<i>Carex emoryi</i>	Emory's Sedge	G5	S2?
<i>Carex gravida</i>	Heavy Sedge	G5	S1
<i>Carex hallii</i>	Hall's Sedge	G4?Q	S3
<i>Carex hystericina</i>	Porcupine Sedge	G5	S3?
<i>Carex parryana</i>	Parry's Sedge	G4	S3?
<i>Carex pedunculata</i>	Stalked Sedge	G5	S3?
<i>Carex prairea</i>	Prairie Sedge	G5	S4?
<i>Carex sterilis</i>	Dioecious Sedge	G4	S2
<i>Carex supina</i> var. <i>spaniocarpa</i>	Weak Sedge	G5T3T5	S2?
<i>Carex tetanica</i>	Rigid Sedge	G4G5	S2
<i>Carex torreyi</i>	Torrey's Sedge	G4	S4
<i>Carex tribuloides</i>	Prickly Sedge	G5	SNA
<i>Carex xerantica</i>	White-scaled Sedge	G5	S3?
<i>Celtis occidentalis</i>	Hackberry	G5	S1
<i>Chamaesyce geyeri</i>	Prostrate Spurge	G5	S1
<i>Chenopodium subglabrum</i>	Smooth Goosefoot	G3G4	S1
<i>Circaea lutetiana</i> ssp. <i>canadensis</i>	Large Enchanter's-nightshade	G5T5	S2
<i>Clematis ligusticifolia</i>	Western Virgin's-bower	G5	S1
<i>Clematis virginiana</i>	Virgin's-bower	G5	S2
<i>Coreopsis tinctoria</i>	Common Tickseed	G5	SH
<i>Corispermum americanum</i> var. <i>americanum</i>	American Bugseed	G5?T5?	S2S3
<i>Corispermum hookeri</i> var. <i>hookeri</i>	Hooker's Bugseed	G4G5T4T5	S1
<i>Corispermum pallasii</i>	Pallas' Bugseed	G4?	SU
<i>Corispermum villosum</i>	Hairy Bugseed	G4?	S1S2
<i>Cornus alternifolia</i>	Alternate-leaved Dogwood	G5	S3
<i>Coryphantha vivipara</i>	Pincushion Cactus	G5	S2
<i>Cryptotaenia canadensis</i>	Honewort	G5	S2
<i>Cycloloma atriplicifolium</i>	Winged Pigseed	G5	S2
<i>Cymopterus acaulis</i>	Plains Cymopterus	G5	S2S3
<i>Cyperus houghtonii</i>	Houghton's Umbrella-sedge	G4?	S2
<i>Cyperus schweinitzii</i>	Schweinitz's Flatsedge	G5	S2
<i>Cypripedium candidum</i>	Small White Lady's-slipper	G4	S2
<i>Dalea villosa</i> var. <i>villosa</i>	Silky Prairie-clover	G5T5	S2S3
<i>Desmodium canadense</i>	Beggar's-lice	G5	S2
<i>Dichanthelium linearifolium</i>	White-haired Panic-grass	GNR	S2
<i>Drosera anglica</i>	Oblong-leaved Sundew	G5	S3
<i>Eleocharis engelmannii</i>	Engelmann's Spike-rush	G4G5	S1
<i>Elymus hystrix</i>	Bottle-brush Grass	G5	S2
<i>Eragrostis hypnoides</i>	Creeping Teal Love Grass	G5	S4
<i>Erigeron caespitosus</i>	Tufted Fleabane	G5	S2
<i>Eriogonum flavum</i>	Yellow Eriogonum	G5	S3
<i>Festuca hallii</i>	Plains Rough Fescue	G4	S3
<i>Festuca subverticillata</i>	Nodding Fescue	G5	S1
<i>Galium aparine</i>	Cleavers	G5	SU
<i>Hackelia floribunda</i>	Large Flowered Stickseed	G5	SU
<i>Helianthus nuttallii</i> ssp. <i>rydbergii</i>	Tuberous-rooted Sunflower	G5T5	S2
<i>Heliotropium curassavicum</i>	Seaside Heliotrope	G5	SH
<i>Hypoxis hirsuta</i>	Yellow Stargrass	G5	S4
<i>Juncus interior</i>	Inland Rush	G4	S1
<i>Krascheninnikovia lanata</i>	Winterfat	G5	S2
<i>Leersia oryzoides</i>	Rice Cutgrass	G5	S3?
<i>Lemna turionifera</i>	Duckweed	G5	SU
<i>Leucophysalis grandiflora</i>	Large White-flowered Ground-cherry	G4?	S3



<i>Linum sulcatum</i>	Grooved Yellow Flax	G5	S3
<i>Lomatium foeniculaceum</i>	Hairy-fruited Parsley	G5	S3
<i>Lomatium macrocarpum</i>	Long-fruited Parsley	G5	S3
<i>Lomatium orientale</i>	White-flowered Parsley	G5	S1
<i>Lomatogonium rotatum</i>	Marsh Felwort	G5	S2S3
<i>Lotus unifoliolatus</i>	prarie trefoil	G5	S2S3
<i>Malaxis monophyllos</i>	White Adder's-mouth	G5	S2?
<i>Malaxis paludosa</i>	Bog Adder's-mouth	G4	S1
<i>Mentzelia decapetala</i>	Gumbo-lily	G5	SH
<i>Mertensia lanceolata</i>	Tall Lungwort	G5	S2
<i>Mimulus glabratus</i>	Smooth Monkeyflower	G5	S1
<i>Mimulus glabratus</i> var. <i>jamesii</i>	Smooth Monkeyflower	G5T5	S1
<i>Musineon divaricatum</i>	Leafy Musineon	G5	S2
<i>Myosurus minimus</i> ssp. <i>minimus</i>	Least Mousetail	G5T5	S1
<i>Nassella viridula</i>	Green Needle Grass	G5	S3
<i>Orobanche ludoviciana</i>	Louisiana Broom-rape	G5	S2
<i>Osmorhiza claytonii</i>	Wooly or Hairy Sweet Cicely	G5	S2
<i>Ostrya virginiana</i>	Hop-hornbeam	G5	S2
<i>Oxytropis sericea</i>	Early Yellow Locoweed	G5	S1
<i>Parietaria pensylvanica</i>	American Pellitory	G5	S4
<i>Penstemon nitidus</i>	Smooth Blue Beard-tongue	G5	S2
<i>Penstemon procerus</i>	Slender Beard-tongue	G5	S1?
<i>Phlox hoodii</i>	Moss Pink	G5	S3
<i>Phryma leptostachya</i>	Lopseed	G5	S3
<i>Piptatherum micranthum</i>	Little-seed Rice Grass	G5	S2
<i>Plagiobothrys scouleri</i> var. <i>scouleri</i>	Scouler's Allocarya	G5TNR	S1
<i>Plantago elongata</i> ssp. <i>elongata</i>	Linear Leaved-plantain	G4T4	S2
<i>Platanthera orbiculata</i>	Round-leaved Bog Orchid	G5	S3
<i>Poa arida</i>	Plains Blue Grass	G5	S4
<i>Poa cusickii</i>	Mutton-grass	G5	S2?
<i>Poa fendleriana</i>	Mutton Grass	G5	S2
<i>Polanisia dodecandra</i> ssp. <i>dodecandra</i>	Clammyweed	G5T5?	S1
<i>Polanisia dodecandra</i> ssp. <i>trachysperma</i>	Clammyweed	G5T5?	S1
<i>Polygala verticillata</i>	Whorled Milkwort	G5	S2
<i>Polygala verticillata</i> var. <i>isocycla</i>	Whorled Milkwort	G5T5	S2
<i>Potamogeton amplifolius</i>	Large-leaved Pondweed	G5	S2?
<i>Potamogeton illinoensis</i>	Illinois Pondweed	G5	S2
<i>Potentilla gracilis</i> var. <i>flabelliformis</i>	Graceful Cinquefoil	G5?	S1
<i>Potentilla plattensis</i>	Low Cinquefoil	G4	S2
<i>Ranunculus cymbalaria</i> var. <i>saximontanus</i>	Seaside Crowfoot	G5T5	S1S2
<i>Rhynchospora alba</i>	White Beakrush	G5	S3?
<i>Rhynchospora capillacea</i>	Horned Beakrush	G4	S2
<i>Sanguinaria canadensis</i>	Blood-root	G5	S2
<i>Schedonnardus paniculatus</i>	Tumble-grass	G5	S2
<i>Selaginella densa</i>	Prairie Spike-moss	G5	S3
<i>Shinersoseris rostrata</i>	Annual Skeletonweed	G5?	S1S2
<i>Sisyrinchium campestre</i>	White-eyed Grass	G5	SU
<i>Sisyrinchium mucronatum</i>	Michaux's Blue-eyed Grass	G5	S1?
<i>Sporobolus neglectus</i>	Annual Dropseed	G5	S3?
<i>Thermopsis rhombifolia</i>	Golden Bean	G5	S2
<i>Townsendia exscapa</i>	Silky Townsend-daisy	G5	S2
<i>Tradescantia occidentalis</i>	Western Spiderwort	G5	S1
<i>Uvularia sessilifolia</i>	Small Bellwort	G5	S2
<i>Verbena bracteata</i>	Bracted Vervain	G5	S3
Vertebrate Animal			
<i>Accipiter cooperii</i>	Cooper's Hawk	G5	S4S5B

<i>Aechmophorus occidentalis</i>	Western Grebe	G5	S4B
<i>Ammodramus bairdii</i>	Baird's Sparrow	G4	S1B
<i>Ammodramus savannarum</i>	Grasshopper Sparrow	G5	S2B
<i>Anthus spragueii</i>	Sprague's Pipit	G4	S2B
<i>Ardea herodias</i>	Great Blue Heron	G5	S4S5B
<i>Asio flammeus</i>	Short-eared Owl	G5	S2S3B
<i>Athene cucularia</i>	Burrowing Owl	G4	S1B
<i>Bubulcus ibis</i>	Cattle Egret	G5	S1S2B
<i>Bufo cognatus</i>	Great Plains Toad	G5	S2
<i>Buteo regalis</i>	Ferruginous Hawk	G4	S1S2B
<i>Calamospiza melanocorys</i>	Lark Bunting	G5	S1B
<i>Calcarius ornatus</i>	Chestnut-collared Longspur	G5	S1S2B
<i>Chaetura pelagica</i>	Chimney Swift	G5	S2B
<i>Charadrius melodus</i>	Piping Plover	G3	S1B
<i>Chelydra serpentina serpentina</i>	Common Snapping Turtle	G5T5	S3
<i>Chlidonias niger</i>	Black Tern	G4	S4B
<i>Chordeiles minor</i>	Common Nighthawk	G5	S3B
<i>Contopus cooperi</i>	Olive-sided Flycatcher	G4	S3S4B
<i>Coturnicops noveboracensis</i>	Yellow Rail	G4	S3S4B
<i>Cygnus buccinator</i>	Trumpeter Swan	G4	S1S2B
<i>Dolichonyx oryzivorus</i>	Bobolink	G5	S4B
<i>Empidonax traillii</i>	Willow Flycatcher	G5	S2S3B
<i>Eremophila alpestris</i>	Horned Lark	G5	S3B
<i>Eumeces septentrionalis</i>	Northern Prairie Skink	G5	S1
<i>Falco peregrinus anatum</i>	Peregrine Falcon		S1B
<i>Heterodon nasicus</i>	Western Hognose Snake	G5	S1S2
<i>Hirundo rustica</i>	Barn Swallow	G5	S4B
<i>Ichthyomyzon castaneus</i>	Chestnut Lamprey	G4	S3S4
<i>Lanius ludovicianus excubitorides</i>	Loggerhead Shrike	G4T4	S2B
<i>Liochlorophis vernalis</i>	Smooth Green Snake	G5	S3S4
<i>Lithobates pipiens</i>	Northern Leopard Frog	G5	S4
<i>Macrhybopsis storeriana</i>	Silver Chub	G5	S3
<i>Melanerpes erythrocephalus</i>	Red-headed Woodpecker	G5	S2B
<i>Mustela frenata</i>	Long-tailed Weasel	G5	S3
<i>Notropis dorsalis</i>	Bigmouth Shiner	G5	S3
<i>Numenius borealis</i>	Eskimo Curlew	GH	SNA
<i>Nycticorax nycticorax</i>	Black-crowned Night-heron	G5	S3S4B
<i>Odocoileus hemionus</i>	Mule or Black-tailed Deer	G5	S3
<i>Phalacrocorax auritus</i>	Double-crested Cormorant	G5	S5B
<i>Podiceps auritus</i>	Horned Grebe	G5	S3B
<i>Podiceps nigricollis</i>	Eared Grebe	G5	S4S5B
<i>Sayornis saya</i>	Say's Phoebe	G5	S2S3B
<i>Spea bombifrons</i>	Plains Spadefoot Toad	G5	S2S3
<i>Sterna forsteri</i>	Forster's Tern	G5	S4B
<i>Storeria occipitomaculata</i>	Northern Redbelly Snake	G5	S3S4
<i>Strix varia</i>	Barred Owl	G5	S4B
<i>Thamnophis radix haydenii</i>	Western Plains Garter Snake	G5T5	S4
<i>Vermivora chrysoptera</i>	Golden-winged Warbler	G4	S3B
<i>Wilsonia canadensis</i>	Canada Warbler	G5	S4B

[▲ Top of Page](#)

[Project Not Found](#)

[Government](#)

[Business](#)

[Residents](#)

[Tourism](#)

[Services](#)

[GO](#)



[News](#) | [Departments](#) | [Disclaimer](#) | [Copyright](#) | [Privacy](#) | [Contact Us](#) 1-866-626-4862

