

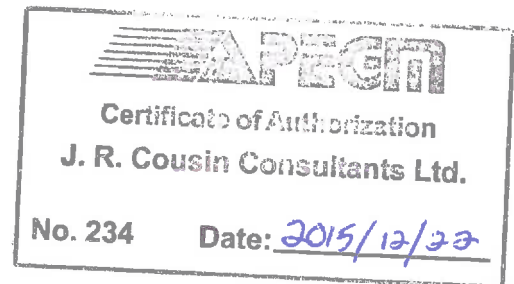

MUNICIPAL WASTE MANAGEMENT LTD
Environment Act Proposal
For the
Waste Disposal Ground Expansion



Prepared by:

Oswald Wohlgemut, M.Sc.
Environmental Scientist



Reviewed by:

Jeff Dyck, P.Eng.
Senior Municipal Engineer

December 2015



ACKNOWLEDGMENTS

To prepare this report various sources of information were investigated and researched. JR Cousin Consultants Ltd. (JRCC) wishes to thank Municipal Waste Management Ltd. who contributed to the data and content of this report. In addition, we wish to commend Municipal Waste Management Ltd. for their fortitude in addressing the need for a long-term solution to solid waste disposal for residents in the surrounding Municipalities and Towns.

REMARKS

JR Cousin Consultants Ltd. has conducted this environment act proposal in accordance with generally accepted professional engineering principles and practices for the purpose of identifying conditions that may have an environmental impact on the site. The findings and recommendations reached in this report are based on information made available to JRCC during the investigation and conditions at the time of the site investigation. Conclusions derived in this report are intended to reduce, but not wholly eliminate the uncertainty regarding potential environmental concerns on the site, and recognizes reasonable limitations with regards to time, accuracy, work scope and cost. It is possible that environmental conditions may change from the date of this report. If conditions appear different from those encountered and expressed in this report, JRCC should be informed so that mitigation recommendations can be reviewed and adjusted as required. Historical data and information obtained from personal communication used in this report, are assumed to be correct, however JRCC has not conducted further investigations into the accuracy of this data. JRCC has produced this report for the use of the client, and takes no responsibility for any third party decisions or actions based on information contained in this report.

TABLE OF CONTENTS

Section	Page of Section
ENVIRONMENT ACT PROPOSAL FORM	i
EXECUTIVE SUMMARY	1
1.0 INTRODUCTION AND BACKGROUND	1
1.1 Introduction	1
1.2 Contact Information	1
1.3 Background Information	1
1.4 Existing Facility	1
1.5 Existing Site Operations	2
1.6 Existing Operating Permit	3
1.7 Description of Previous Studies	3
1.8 Project Description	4
2.0 DESCRIPTION OF THE DEVELOPMENT	1
2.1 Land Title/Location	1
2.2 Owner of Land and Mineral Rights	1
2.3 Existing Land Use	1
2.4 Land Use Designation/Zoning Designation	1
2.5 Description of Development	2
2.5.1 Project Schedule	2
2.5.2 Basis for Proposed WDG Upgrade and Expansion Site Selection	2
2.5.3 Siting Concerns	3
2.5.4 Projected Service Population	3
2.5.5 Projected Waste Generation	4
2.5.5.1 Solid Waste Density	5
2.5.5.2 Waste Generation (Residential, Commercial and Industrial)	5
2.5.5.3 Waste Generation (SRM and Deadstock)	5
2.5.5.4 Recycling	5
2.5.5.5 Waste Generation Summary Table	6
2.5.6 Topography and Geotechnical Review	6
2.5.6.1 Past Geotechnical Investigations	6
2.5.6.2 Onsite Geotechnical Investigation	7
2.5.6.3 Topography	10
2.5.6.4 Groundwater Elevation and Flow Direction	10
2.5.7 WDG Cell Liner Requirements	11
2.5.8 Contaminant Migration	11
2.5.9 Conceptual Design	12
2.5.9.1 Proposed Development	12
2.5.9.2 Storage Requirements	13
2.5.9.3 Conceptual Liner Design	13
2.5.9.4 Monitoring Wells	14
2.5.9.5 Cover System	14
2.5.9.6 Cell Closure	15

2.5.9.7	Leachate Management System.....	15
2.5.9.8	Contaminated Soils Area	17
2.5.9.9	Drainage.....	17
2.5.9.10	Access Road	18
2.5.9.11	Fencing and Signage.....	18
2.5.10	Construction Techniques.....	18
2.5.11	Decommissioning and Closure	19
2.5.12	WDG Maintenance and Operation.....	19
2.5.12.1	General Site Operation and Maintenance.....	19
2.5.12.2	Contaminated Soils Area Operation and Maintenance	20
3.0	POTENTIAL ENVIRONMENTAL IMPACTS	1
3.1	Releases to Air, Water, Land	1
3.1.1	Air.....	1
3.1.2	Water.....	1
3.1.3	Land	1
3.2	Wildlife	2
3.3	Fisheries.....	2
3.4	Forestry.....	2
3.5	Vegetation.....	2
3.6	Noise Impacts	3
3.7	Health and Safety	3
3.8	Heritage Resources.....	3
3.9	Socio-Economic Implications	3
3.10	Aesthetics	4
4.0	MANAGEMENT PRACTICE	1
4.1	Mitigation of Impacts to Air	1
4.2	Mitigation of Impacts to Water	1
4.3	Mitigation of Impacts to Land.....	2
4.4	Mitigation of Noise Impacts	2
4.5	Mitigation of Impacts to Health and Safety.....	2
4.6	Mitigation of Impacts to Heritage Resources	3
4.7	Aesthetics	3
5.0	RESIDUAL AND CUMULATIVE EFFECTS.....	1
6.0	MONITORING AND FOLLOW-UP	1
7.0	FUNDING AND APPROVALS	1
8.0	PUBLIC CONSULTATION	1
9.0	CONCLUSION	1

Appendix A

Certificate of Title

Crown Lands & Property Agency - Lands Branch, September 17, 2015 Email Correspondence

Appendix B

Table 1: Waste Generation Projections – Municipal Waste Management

Manitoba Conservation and Water Stewardship - Wildlife and Ecosystem Protection Branch, October 23, 2015
Email Correspondence

Appendix C

Test Hole Logs

AMEC Foster Wheeler Environment and Infrastructure – Soils Analysis Report, October 28, 2015

Driller Well Log Reports

Appendix D

Title Page

Plan 1: Site Location Plan with Required Setbacks

Plan 2: Waste Disposal Ground Site with Test hole Location Plan

Plan 3: Proposed Waste Disposal Ground Expansion Layout and Drainage Plan

Plan 4: Dike, Liner and Leachate Pipe Details

Plan 5: Road, Ditch, Fence, Sign and Silt Fence Details

Plan 6: Site Operations Plan

Environment Act Proposal Form



Name of the development: Municipal Waste Management Waste Disposal Ground Expansion	
Type of development per Classes of Development Regulation (Manitoba Regulation 164/88): Class 1	
Legal name of the applicant: Municipal Waste Management	
Mailing address of the applicant: Box 84	
Contact Person: Mr. Tim Oliver	
City: Goodlands	Province: Manitoba Postal Code: R0M 0R0
Phone Number: (204) 483-3986	Fax: email: toliver@mwm ltd.ca
Location of the development: Municipality of Souris-Glenwood	
Contact Person: Mr. Tim Oliver	
Street Address:	
Legal Description: SW 35-8-21 WPM	
City/Town: Goodlands	Province: Manitoba Postal Code: R0M 0R0
Phone Number: (204) 483-3986	Fax: email: toliver@mwm ltd.ca
Name of proponent contact person for purposes of the environmental assessment: Jeff Dyck, JR Cousin Consultants Ltd.	
Phone: 204-489-0474	Mailing address: 91 A Scurfield Blvd
Fax: 204-489-0487	Winnipeg, Manitoba
	R3Y1G4
Email address: jd Dyck@jrcc.ca	
Webpage address: www.jrcc.ca	
Date: DEC 22 2015	Signature of proponent, or corporate principal of corporate proponent: 
	Printed name: Jeff Dyck

EXECUTIVE SUMMARY

General

Municipal Waste Management Ltd. is proposing to construct an expansion to the existing Class I Waste Disposal Ground located at SW 35-8-21 WPM in the Municipality of Souris-Glenwood, Manitoba. An Environment Act Licence is required from Manitoba Conservation for the expansion and continued operation of the waste disposal ground (WDG). JR Cousin Consultants Ltd. (JRCC) was retained for the engineering services.

Description

The proposed expansion of the WDG would continue to service residents and commercial sites throughout the surrounding municipalities and towns. The service population currently utilizes the WDG by collection truck, roll off bin and individual drop off. The WDG expansion would include constructing an initial waste disposal cell to the west of the existing waste disposal cell and leachate pond, with a minimum life span of approximately 10 years. Additional expansion cells would also be constructed in the future in the surrounding expansion area over a design period of 25 years. In addition, a contaminated soils cell will be constructed in the expansion area to the west of the existing site activities. Associated ditching, fencing, and access roads to the expansion areas will be constructed/installed.

The existing WDG and proposed expansion area are located approximately 8 km northeast of the Town of Souris, Manitoba. The expansion area is located on cleared agricultural land, with Municipal Road 47 N bordering the site to the south and agricultural land surrounding the property on all sides.

Population and Waste Generation

The projected year 25 service population utilizing the WDG would include the surrounding municipalities and towns, which utilize the site partially for household waste or for commercial/industrial waste only, as many of the municipalities operate separate WDG sites or transfer stations.

Based on recorded waste tonnage received at the WDG site and an average solid waste density of 475 kg/m^3 , the current annual volume of waste received is estimated to be $11,347 \text{ m}^3/\text{year}$, which is projected to increase to approximately $22,102 \text{ m}^3/\text{year}$ in design year 25.

Topographical Survey and Geotechnical Investigation

The land surrounding the existing active waste disposal activities to the west, north and east was investigated for the location of the potential expansion cells. The general soil profile consisted of surficial black topsoil followed by mixed layers of high plastic silt and clay, and low plastic sand and silt to depths of 1.5 m – 3.4 m below the surface, followed by a consistent layer of high plastic clay till down to the bottom of the test holes at 12.0 m below the surface. These layers were not consistently found in the same order in each of the test holes or with the same thickness throughout the expansion area. Bedrock or refusal was not encountered. Short term standing water was recorded at depths of 5.0 m to 8.7 m below the surface, in five of the nine test holes.

The laboratory analysis indicated that the majority of the soils on the site were high plastic clay and silt. The surficial clay and silt (0.2 m – 1.5 m) obtained a hydraulic conductivity of $5.9 \times 10^{-9} \text{ cm/sec}$ after being reworked, while the deeper clay and silt (1.5 m – 5.3 m) obtained a hydraulic conductivity of $1.2 \times 10^{-8} \text{ cm/sec}$ in an

undisturbed, in situ state. Based on the results, the high plastic clay and silt material is expected to meet the requirements for a clay waste disposal cell liner, according to Manitoba Conservation, achieving a consistent hydraulic conductivity of 1×10^{-7} cm/sec or less.

Liner Construction

Based on the results of the laboratory testing, the horizontal liner (i.e. floor) of the expansion cells and contaminated soils pad would be constructed of in situ (undisturbed) high plastic clay and silt material found at the site, while the vertical cutoff walls of the expansion cell dikes would be constructed of reworked high plastic clay and silt from the site excavation. The liners would be a minimum of 1.0 m thick and the vertical cutoff wall would tie into the horizontal liner to form a continuous barrier.

Cell Design Considerations

The dikes of the WDG expansion cells will be constructed of excavated soil material with 3H:1V interior slopes and dike tops 3.0 m wide. It is estimated that the expansion cells will be constructed approximately 2.0 m below grade and waste will be extended to approximately 4.0 m above grade. The cells will be constructed with leachate collection piping in the floor of the cell, which will connect to the existing leachate collection sump pit.

The contaminated soils pad will have a surface area of approximately 6800 m² (170 m x 40 m) and will have a perimeter ditch within the cell to collect runoff. The surrounding berm will be approximately 0.5 m above grade and the operator will construct separation berms within the cell to segregate loads from different contaminated soil sources. The expansion cells and contaminated soils cell will require perimeter ditching around the outside of the dikes/berms and mesh fencing surrounding the active areas for containment of litter and to prevent unauthorized entry. An area will be designated for non-contaminated soils stockpiling, for future use as cover material.

Potential Concerns and Mitigation Measures

From discussions with the client and a review of the current site operations, the potential concerns identified with the expansion of the WDG and associated mitigation measures include:

Potential Concern	Mitigation Measure
Odours from expansion cells and contaminated soils cell	The expansion site is beyond required setbacks from residents and regular cover material will reduce nuisance odours
Leachate contamination of surface and groundwater from expansion cells	Expansion cells will utilize a soil liner for containment of leachate and a leachate evaporation pond will be used for leachate storage onsite
Windblown litter impacting surrounding land	Fencing will be placed around the perimeter of the active areas to contain windblown litter on the WDG property
Soil erosion after construction of expansion cells	Areas with bare soil outside of the expansion cells will be seeded with grass to reduce erosion

Potential Concern	Mitigation Measure
Spills or leaks during construction	Contractor to have emergency spill kit on site. Hazardous materials and fuel to be handled in accordance with all federal and provincial regulations
Reduce aesthetics of area	Slopes will be seeded after construction and the site will be regularly cleaned up of litter to maintain aesthetics and reduce visual impacts from the access road
Health and safety	Construction workers will be required to adhere to the safety program which will include utilizing personal protective equipment while on site Access to the active face of the expansion cells will be restricted to WDG staff

Schedule and Approvals

Municipal Waste Management would like to begin construction of the contaminated soils cell as soon as possible, while the initial expansion cell would be constructed when the existing waste disposal cells are nearer to reaching capacity. No additional approvals, licences or permits are expected for the works, beyond the Environment Act Licence from Manitoba Conservation.

1.0 INTRODUCTION AND BACKGROUND

The development described herein is for the operation of the existing Municipal Waste Management Ltd. (MWM) waste disposal ground and future construction of waste disposal expansion cells at the facility.

1.1 Introduction

The Municipal Waste Management Ltd. waste disposal facility is a Class 1 waste disposal ground (WDG) located at SW 35-8-21 WPM in the Municipality of Souris-Glenwood, Manitoba. The conceptual design of the WDG expansion would be based upon a projected year 25 service population for residents in the surrounding municipalities and towns. Based on correspondence with Manitoba Conservation, the facility requires a new Environment Act Licence for the continued operation of the site and for any future expansion works. JR Cousin Consultants Ltd. (JRCC) was retained for the engineering services.

1.2 Contact Information

Mr. Jeff Dyck, P.Eng.
JR Cousin Consultants Ltd.
91A Scurfield Blvd.
Winnipeg, Manitoba
R3Y 1G4
Phone (204) 489-0474, Fax (204) 489-0487

Mr. Tim Oliver
Municipal Waste Management Ltd.
Box 84
Goodlands, Manitoba
R0M 0R0
Phone (204) 483-3986

1.3 Background Information

The WDG, owned and operated by Municipal Waste Management Ltd., is located approximately 8 km northeast of the Town of Souris, Manitoba (see Plan 1 attached in Appendix D). The existing WDG services the residents in the Municipalities of Souris-Glenwood, Two Borders, Oakview, Brenda-Waskada, Oakland-Wawanesa, Cartwright-Roblin, Sifton, Glenboro-South Cypress and Deloraine-Winchester, along with the Towns of Cartwright, Deloraine, Glenboro, Oak Lake, Souris, Waskada, Wawanesa and Virden. The site receives construction, industrial and household waste, along with animal deadstock and asbestos. Recyclable materials, such as used tires, and scrap metals are temporarily stored at the site, along with used oil. Waste and recyclable materials are dropped off by individuals and by municipalities and towns with waste collection trucks. The site is located along Road 47 N, in the Municipality of Souris-Glenwood. The land surrounding the existing WDG is agricultural land.

1.4 Existing Facility

The existing WDG currently operates with the following compounds/facilities:

- Active waste disposal cell – below and above grade (approximately 3.0 m below grade and 3.5 m above grade)
- Leachate evaporation pond – below grade pond with a depth of approximately 2.5 m from the floor to the top of dike
- Leachate sump pit – a below grade sump pit (approximately 7.0 m below grade) for leachate collection and pumping to the leachate pond
- SRM and deadstock cell – below grade cell for animal carcasses
- Metals storage – above ground area for bulk metals and appliances
- Tires storage – above ground area for used tires
- Used oil tank – above ground tank (2,000 L) for used oil disposal
- Recyclables bin – a roll off bin utilized for comingled recyclable materials
- Construction waste storage – above ground area for used brick and concrete demolition waste
- Operator building – a heated operator building with electrical power
- Equipment storage buildings – two heated storage and maintenance buildings.

The site also has the following features:

- a perimeter fence (1.8 m high) of fixed knot game fencing
- nine groundwater monitoring wells located at four locations surrounding the active portions of the site
- an internal access road (6.5 m wide) of compacted granular material
- a lockable entrance gate
- site signage (i.e. entrance sign and drop off location signs)
- a weigh scale (35,000 kg capacity) at the entrance to the site
- several roll off bins for off-site rental
- two above ground fuel tanks (one for diesel and one for gasoline) for equipment refueling.

1.5 Existing Site Operations

The WDG is operated with a below and above ground active cell and several areas and bins used for material separation, storage and recycling. During daily operations, the site has a gate attendant who handles tipping fees and directs individuals to the appropriate drop off locations, while a site operator conducts general site cleanup and waste movement, compaction and covering. The site has two tracked loaders, a tracked backhoe, and a landfill compactor that are dedicated for the site maintenance and are used for the waste movement, compaction, covering and excavation.

The recyclable materials stored on the site (i.e. tires, metals and recyclables) are hauled away when the storage areas/bins are nearing capacity. The used oil tank is emptied and hauled away by a licensed hazardous waste hauler when it reaches capacity. The SRM and deadstock pit is covered with soil material within 24 hours of dumping. The interior site access roads, compounds and cells are maintained

and cleared of snow throughout the winter to allow continued access to the site by the public during operating hours. The heavy equipment is maintained and stored in the equipment buildings.

The leachate sump pit onsite is monitored and pumped out periodically into the leachate pond. The monitoring wells at the site are sampled and tested annually.

1.6 Existing Operating Permit

The WDG is operating under the current operating permit (No. 36924) which has provisions for the following:

- site supervision during operating hours
- a locked gate or barrier for restricting site access
- site signage and entrance sign (with dates and hours of operation and types of waste accepted)
- waste covering
- site drainage
- recyclable materials segregation in designated areas
- site cleanup of litter along access roads and perimeter of site (minimum of twice a year)
- preventing disposal of liquid waste or liquid industrial waste
- guidelines for collection and disposal of hazardous waste material
- handling and covering animal carcasses
- implementing control measures to prevent scavengers and rodents
- submission of a environment act proposal for the continued operation of the facility
- construction requirements for future waste disposal cells
- soil sampling of newly constructed cells
- fire reporting
- prevention of burning at the site
- groundwater monitoring requirements, frequency and submission of annual report.

1.7 Description of Previous Studies

There were two reports completed by Roper Environmental Engineering Inc. (REE) that were reviewed for background information on the hydrogeological conditions of the site. The first report entitled *Proposed Regional Landfill, SW 35-8-21 WPM, Hydrogeologic Assessment*, completed in January 1992, included a review of past regional hydrogeologic data, site soil sampling and monitoring well installation. The report indicated that the soils consisted of clayey till and clay to a depth of 22 m below the surface, with little water accumulation. The site hydrogeologic conditions were considered favourable for the construction of a landfill with containment of leachate.

The second report completed by REE in November 1992, included hydrogeologic data from additional test holes and monitoring wells at the site. The results confirmed the findings in first report, and the

permeability testing conducted indicated that the till soils at the site had a hydraulic conductivity range of 8.8×10^{-7} cm/sec to 1.0×10^{-8} cm/sec.

The original *Municipal Waste Management Ltd. Waste Disposal Ground Environment Act Proposal* prepared by JRCC in February 1994, was also reviewed for background information on site conditions and proposed site design. There were no potential environmental or health and safety concerns identified in the study.

1.8 Project Description

As requested by MWM, the existing facility is in need of expansion waste disposal cells, and a contaminated soils remediation cell, in accordance with the current provincial guidelines and regulations governing WDG sites. The site expansion will be designed to handle the long-term waste generation from the service population in the surrounding municipalities and towns, to design year 25. An Environment Act Proposal is also required for the construct of a contaminated soils cell and the continued operation of the existing Class 1 WDG. In addition, an area of the property will be designated for stockpiling non-contaminated soils hauled to the WDG.

2.0 DESCRIPTION OF THE DEVELOPMENT

For each heading there is an information request from the Environment Act Proposal Form. These requests are repeated herein in italics followed by the pertaining response.

2.1 Land Title/Location

Certificate of Title showing the owner(s) and legal description of the land upon which the development will be constructed; or, in the case of highways, rail lines, electrical transmission lines, or pipelines, a map or maps at a scale no less than 1:50,000 showing the location of the proposed development:

The existing WDG and proposed expansion site is located at SW 35-8-21 WPM, approximately 8 km northeast of the Town of Souris, Manitoba. The expansion area is the entire quarter section of cleared agricultural land with a tree line along the border of the property. The lands surrounding the proposed expansion area are also agricultural, with Municipal Road 47 N bordering the site to the south. The land parcel is currently owned by MWM under certificate of title number 221236 (attached in Appendix A).

2.2 Owner of Land and Mineral Rights

Owner of land upon which the development is intended to be constructed, and of mineral rights beneath the land, if different from surface owner:

The Crown Lands & Property Agency was contacted regarding the ownership of the mines and minerals at the proposed development location. According to the Crown Lands & Property Agency, the ownership of the mines and minerals, and the sand and gravel remains with the surface title (owned by Municipal Waste Management) (see email correspondence from the Crown Lands & Property Agency in Appendix A).

2.3 Existing Land Use

Existing land use on the site and on land adjoining it, as well as changes that will be made in such land use for the purposes of the development:

The proposed expansion cells would be located in areas of cleared agricultural land, currently used for grain production. The surrounding adjacent lands are also agricultural and are currently being used for crop production. The nearest residence is a farmyard located approximately 900 m to the northeast of the WDG property boundary. The outskirts of the Town of Souris are located approximately 8 km to the southwest of the WDG, while the Community of Beresford is located approximately 3.6 km to the northeast of the WDG (see Plan 1 in Appendix D).

2.4 Land Use Designation/Zoning Designation

Land use designation for the site and adjoining land as identified in a development plan adopted under The Planning Act or The City of Winnipeg Act, and the zoning designation as identified in a zoning by-law, if applicable:

Based on information provided by the municipality, the WDG site is currently zoned as Agricultural General, with a condition for use as a waste disposal ground.

2.5 Description of Development

Description of proposed development and schedule for stages of the development, including proposed dates for planning, design, construction, commissioning, operation, and decommissioning and/or termination of operation (if known), identifying major components and activities of the development as applicable (e.g. access road, airstrip, processing facility, waste disposal area, etc.).

2.5.1 Project Schedule

The construction of new expansion cells is not expected for several years, due to existing capacity in the current waste disposal cell. However, MWM would like to proceed with the construction of a contaminated soils pad as soon as possible. No date for decommissioning has been set for the existing waste disposal cell, however the expansion cells would be designed for a projected year 25 service population, and a WDG capacity assessment should be conducted as the WDG approaches this year 25 design life.

2.5.2 Basis for Proposed WDG Upgrade and Expansion Site Selection

The location for the WDG expansion works was chosen based on discussions with MWM and from a site investigation conducted by JRCC in September of 2015. The siting of the expansion was considered based on availability of land and proximity to nearby rural residents and sensitive areas.

According to the *Guidelines for the Siting of a Class I Waste Disposal Ground in Manitoba* (1994), the siting of a waste disposal cell on a Class 1 facility are limited by the following site features and minimum setback requirements:

- watersheds with surface water flow through the site
- sites underlain with sand, gravel, sandstone, limestone
- sites on the edge of steep slopes, subject to erosion and land sliding
- sites within 2 km of wetlands
- bedrock outcrops
- karst terrain
- fractured bedrock
- unstable terrain
- areas of unpredictable geology
- sites with shallow water tables or perched aquifers
- groundwater pollution hazard areas
- areas within 100 year flood plain

- areas with limited access to roads or utilities
- sites within 400 m of a residence
- sites within 400 m of a potable water well
- sites within 400 m of a cemetery
- sites within 2 km of a critical habitat area
- sites within 2 km of a designated park or historic site
- sites within 100 m from a public road or railway right of way
- sites within 1 km from a body of surface water
- sites within 8 km of an airport or setback as described in the local zoning plan.

An important concern in evaluating Class I WDG sites is the protection of water quality, and human health and safety. The above setbacks also consider aesthetic qualities of the surrounding landscape and safety issues for nearby transportation routes.

The above siting requirements are established to ensure that if a WDG fails to adequately contain leachate, the site's natural conditions will protect groundwater and surface water resources, and control the migration of landfill gases. Preference should be given to sites located in areas where there is clay or till of low permeability (1×10^{-7} cm/sec or less) to ensure groundwater protection and minimal migration of landfill gases. If soils of sufficiently low permeability are not available, a geomembrane liner should be considered for containment.

2.5.3 Siting Concerns

Based on the proposed location of the WDG expansion, the concerns regarding siting include:

- Distance to surface water body – there are small natural wetlands/ponds within the expansion area and surrounding the boundary within 800 m, due to the undulating landscape, however there are no creeks, streams or rivers or extensive wetland areas within 800 m.
- Distance to nearest airport – the proposed expansion area is located approximately 6.5 km from the nearest airstrip near Souris, Manitoba. This airstrip is considered a registered aerodrome and not a certified airport, therefore the federal siting restrictions to this site do not apply.

Variances for these setbacks are being requested from Manitoba Conservation by way of this EAP. Plan 1 in Appendix D, shows the minimum setback requirements as described above.

2.5.4 Projected Service Population

A review of the service population for the Municipal Waste Management (MWM) facility was conducted to assess the current and projected waste disposal requirements. The assessment was utilized to determine the sizing requirements for the proposed expansion cells at the waste disposal ground.

The service population was determined from discussions with MWM. This service population utilizing the MWM facility includes residents in the Municipalities of:

- Souris-Glenwood
- Two Borders
- Oakview
- Brenda-Waskada
- Oakland-Wawanesa
- Cartwright-Roblin
- Sifton-Oak Lake
- Glenboro-South Cypress
- Deloraine-Winchester.

In addition to the municipalities above the following Towns also contribute to waste loading at the WDG:

- Cartwright
- Deloraine
- Glenboro
- Oak Lake
- Souris
- Waskada
- Wawanesa.

The majority of the above municipalities and towns utilize the MWM facility partially or for commercial/industrial waste only. The majority of the above municipalities and towns also operate separate WDGs and transfer station sites which also receive residential/commercial/industrial waste from the local populations. As MWM does not separately record waste deposited by different service populations, it is difficult to determine the exact waste tonnage from each municipality and town.

In addition to the municipalities and towns listed above, there are also various construction sites and larger industrial contributors across western Manitoba that utilize the MWM facility, such as Tundra Oil and Gas and Maple Leaf Agri-Farms.

2.5.5 Projected Waste Generation

The projected amount of solid waste generated by the service population was estimated from waste hauling records kept by MWM. This projected amount of solid waste received at the WDG site was utilized in sizing the expansion cells.

2.5.5.1 Solid Waste Density

A solid waste density of 300 kg/m³ is typical for compacted solid waste from a compacting collection truck, whereas a density of 175 kg/m³ is typical for an uncompacted waste. As both compacted and uncompacted waste is received at the WDG site, the determination of solid waste density was based on the compaction occurring onsite in the active waste disposal cell. The WDG utilizes a waste compactor regularly, which can typically compact waste to a solid waste density of 475 kg/m³ if compaction occurs regularly. This density was utilized in estimating the volume of waste received in the waste disposal cells, as the operator indicated that compaction occurs regularly at the site.

2.5.5.2 Waste Generation (Residential, Commercial and Industrial)

The WDG has utilized a weigh scale at the entrance to the site to record tonnes of waste hauled to the site for several years. The latest (2014) waste receiving records indicated that the site received 5,390 tonnes of residential, commercial and industrial waste, which is an increase of approximately 2.2% over the 2013 waste tonnage. Based on discussion with MWM, a 2.5% increase in waste tonnage per year was estimated to be suitable for sizing the expansion cells to design year 25. Based on a solid waste density of 475 kg/m³, the current annual volume of this waste received is 11,347 m³/year and would increase to 22,102 m³/year in design year 25.

2.5.5.3 Waste Generation (SRM and Deadstock)

The WDG also receives SRM (specified risk material), which refers to cattle tissue that is potentially infected with bovine spongiform encephalopathy (BSE), along with other deadstock (i.e. animal carcasses). This material requires a specified permit and is buried in a separate cell of the landfill. The landfill operators record this waste material separately from the residential, commercial or industrial waste described in Section 2.5.5.2 above. The latest (2014) waste receiving records indicated that the site received 287 tonnes of SRM and deadstock waste. Based on discussion with MWM, a 2.5% increase in waste tonnage per year was also estimated to be suitable for sizing the future landfill deadstock cells, to design year 25. As the majority of the animal carcasses are formed of liquid, a solid waste density of 1000 kg/m³ (i.e. density of water) was utilized for this waste material. The current annual volume of this waste received is 287 m³/year and would increase to 559 m³/year in design year 25.

2.5.5.4 Recycling

A minimal amount of recyclable material is dropped off at the WDG, such as metals, tires, copper wiring, aluminum and plastics. The copper, metals and aluminum are separated and hauled to various processing facilities. While the remainder of the recycling material is co-mingled in roll off bins and hauled to the recycling depot in Brandon. The recycling material received at the WDG site is not included in the total

waste tonnage reported in Section 2.5.5.2 above and is not being considered in the site expansion cells, as this material is regularly hauled off site for processing and it is assumed that the existing compounds/designated areas will continue to be utilized in the future.

2.5.5.5 Waste Generation Summary Table

The current and projected waste generation rates for the service area have been included in the summary table below and in the attached Table 1 (Appendix B).

Contributing Waste Source	Current Annual Waste Generation (m ³ /year)	Year 25 Annual Waste Generation (m ³ /year)
Residential, Commercial and Industrial	11,347	22,102
SRM and Deadstock	287	559
Total	11,634	22,661

2.5.6 Topography and Geotechnical Review

An onsite geotechnical and topographical investigation was completed and a background review of past reports and mapping was completed.

2.5.6.1 Past Geotechnical Investigations

Groundwater Driller Well Logs

Driller well log reports for the quarter section of the existing WDG were reviewed for background soils and groundwater information. Soils consisted of surficial topsoil (0.6 m) followed by clay till, down to approximately 15 m below the surface. Below this were alternating layers of sand and till down to approximately 47 m below the surface, at which depth shale was encountered. No groundwater data was recorded in these reports.

Canada-Manitoba Soil Survey Information

A detailed soil survey report was not available for the MWM site area, however the Reconnaissance Soil Survey Report (no. 6) for the general area was reviewed. Based on this report, the soils are classified as Harding Clay to Silty Clay and Beresford Clay Loam Associations and are described as follows:

- Beresford Association consists of clay loam soils developed on a thin covering of lacustrine sediment over calcareous boulder till. Surface topography is level to very gently sloping and surface drainage is generally restricted to runoff into local depressions.

- Harding Association consists of clay textured soils developed on shallow lacustrine clay deposits over glacial till. Surface topography is generally flat to very gently sloping and drainage is slow.

Past Geotechnical Investigation

As described briefly in Section 1.4 above, geotechnical testing was completed at the site in 1992 by REE, prior to construction of the current WDG. These investigations identified the soil profile as consisting of oxidized clay till (7 m to 10 m) followed by grey, silty clay till to approximately 30 m below the surface. Below this were layers of sand, clay till to the shale bedrock found at approximately 48 m below the surface. No significant water bearing zones were present in the first 31 m of till material below the surface. The hydraulic conductivity of the till material ranged between 8.8×10^{-7} cm/sec and 1.0×10^{-8} cm/sec, while the vertical flow velocities in the till ranged from 0.012 m/yr to 0.13 m/year. Based on the vertical flow velocity, it would take approximately 150 years for leachate to reach the underlying water bearing zone. There were also five monitoring wells installed throughout the property to monitor water quality.

2.5.6.2 Onsite Geotechnical Investigation

An onsite investigation of was conducted by JR Cousin Consultants Ltd. on September 9 and 10, 2015. This site investigation included drilling test holes and conducting a topographic survey in the existing and proposed expansion area.

A tracked drill rig was utilized for observing the soil profile and obtaining samples from the test holes, under the direct supervision of JRCC personnel. The land immediately surrounding the existing WDG cells to the north, east and west (within the property boundary), was investigated as a proposed expansion area for future expansion cells. The land was investigated to determine whether the soils would be suitable for use as a clay cell liner in an undisturbed state (in situ) or after reworking, and whether soils could be used for potential borrow material during construction.

During the site investigation, nine test holes were drilled to a maximum depth of 12.0 m. The test hole locations are shown on Plan 2, attached in Appendix D.

The subsurface soil profile within each test hole was logged, water conditions were noted, and representative soil samples were collected as the soils varied along the profile. The samples were visually field-classified and confirmed through laboratory analysis. Shelby tubes of undisturbed in situ soil were collected in various test holes and at depths appropriate for a WDG cell liner. Bulk samples were also collected in various test holes and at various depths if testing of a reworked soil sample was deemed necessary. Following completion of the test holes, an assessment of the short term groundwater conditions was completed by measuring the static water level in the test holes and determining the elevation of water infiltration into the test

holes. All test holes were then backfilled with excavation material and bentonite. Details of each test hole soil profile, including depth and description of each soil layer, as well as comments on groundwater infiltration can be found in the test hole logs attached in Appendix C.

Soil Profile

Based on the soils observed in the test holes, the subsurface soil profile was fairly consistent across the testing area, with similar soil types were observed in the majority of the test holes.

The general soil profile consisted of a layer of surficial black topsoil approximately 0.2 m thick, followed by layers of silt till and silty clay till, with thin layers of fine grain sand to depths of 0.7 m – 3.4 m below the surface. Below this was a consistent layer of high plastic clay till, observed at 4.5 m to 7.5 m thick, followed by alternating layers of silty clay, silt till and high plastic clay till to the bottom of the test holes. These alternating layers below the high plastic clay till were not consistently found in the same order in each of the test holes or with the same profile thickness. The following table summarizes the general soil profile observed of the major soil types:

Primary Soil Type	Depth Range of Soil layer	Secondary Soil Characteristics
Topsoil	0 m – 0.2 m	clayey
Clay Till – high plastic	0.2 m – 3.4 m	silty
Silt and Sand – low plastic	0.2 m – 1.5 m	clayey
Clay Till – high plastic	1.5 m – 12 m	silty

Details of the soil profile in each test hole can be found in the test hole logs, attached in Appendix C, along with an elevation profile of the soil layers in the test holes.

Groundwater and Bedrock

Water infiltration and short-term water accumulation was recorded in the test holes during the test hole drilling and prior to backfilling. Standing water was recorded in five of the test holes at depths of 5.0 m to 8.7 m below the surface. The groundwater levels recorded in the test holes can vary based on seasonal conditions, i.e. snowmelt and high precipitation during rainy seasons. Standing water recorded is also affected by the length of time the test holes are open and the degree to which the test hole caves in after drilling, and this varied from test hole to test hole. Details of the standing water levels and caving conditions were identified on the test hole logs attached in Appendix C.

Refusal or bedrock was not encountered at any of the test holes.

Contractors would be made aware of the geotechnical conditions encountered onsite, as dewatering and slope stabilization may be required during construction, depending on the depth of excavation determined during final design.

Laboratory Analysis

Representative soil samples from the proposed WDG expansion area were submitted to AMEC Foster Wheeler for testing and analysis. The following is a summary of the test results, while details of soils analysis and testing results from the laboratory are attached in Appendix C.

There were four representative bag samples that were analyzed for the following:

- Atterberg Limits (plastic limit, liquid limit, and plasticity index, ASTM D4318)
- Soil Classification (ASTM D2487)
- Moisture Content (ASTM D2216)
- Particle Size Analysis (Hydrometer test, ASTM D422).

One representative Shelby tube sample was tested for:

- Hydraulic Conductivity (ASTM D5084).

One representative bulk sample was reworked and tested for:

- Standard Proctor Density (ASTM D698)
- Hydraulic Conductivity (ASTM D5084).

The four bag samples analyzed were from the following test holes:

- TH1 1.8 m – 2.8 m
- TH1 2.8 m – 7.5 m
- TH4 0.2 m – 1.5 m
- TH4 1.5 m – 5.3 m.

The Shelby tube sample analyzed was from the following test hole:

- TH4 1.5 m – 2.1 m.

The reworked bulk sample analyzed was from the following test hole:

- TH4 0.2 m – 1.5 m.

JRCC requested that the laboratory also provide a professional assessment, based on the analysis and the testing, as to whether the soil samples could achieve a permeability of 1×10^{-7} cm/sec or less in their in situ and reworked states. A summary of the laboratory results are as follows:

Sample ID	Soil Classification	Hydraulic Conductivity
TH1 1.8 m – 2.8 m	CH – high plastic silt and clay	
TH1 2.8 m – 7.5 m	CH – high plastic clay and silt	
TH4 0.2 m – 1.5 m	CH – high plastic clay and silt	5.9×10^{-9} cm/sec (reworked)
TH4 1.5 m – 5.3 m	CH – high plastic clay and silt	1.2×10^{-8} cm/sec (in situ)

The laboratory indicated that soils with the following characteristics would provide a liner with a hydraulic conductivity of 1×10^{-7} cm/sec or less:

- Liquid limit of 30% or greater;
- Plastic index of 10% or greater;
- 30% or more passing a number 200 mesh sieve ;
- 20% or more of clay particles.

The soil samples submitted had a liquid limit ranging from 52% - 64%; a plastic index ranging from 37% - 46%; and a clay content ranging from 41.3% - 51.1%. Therefore, based on the above results all of the soil samples submitted from TH1 and TH4 would meet the above criteria and would be expected to achieve a hydraulic conductivity of 1×10^{-7} cm/sec or less.

2.5.6.3 Topography

A topographical survey of the existing WDG site features and the proposed expansion area and the test holes in was completed using GPS survey equipment. Based on site observations, the general expansion area surrounding the existing WDG to the west, north and east was undulating, with several low lying wetlands, ponds or temporarily wet areas with standing water. Based on the measurements able to be taken, the elevations of the low lying ponds ranged from 1.1 m to 1.8 m below the surrounding prairie grade. The agricultural land surrounding these low lying ponds was gently sloped towards the north and west, with an average elevation difference of approximately 3.5 m across the site, at a slope of 0.4%. The ditch along Road 47 N, to the south, was sloped towards the west away from the WDG site.

2.5.6.4 Groundwater Elevation and Flow Direction

The groundwater elevation was calculated based on the ground elevation at each monitoring well and the measured depth to groundwater (by others). The groundwater measurements were recorded in November of 2014 by Agra-Gold Consulting Ltd. The ground elevation was determined utilizing GPS survey equipment during the September 2015 site investigation. A summary of the groundwater elevations and depth to groundwater in the monitoring wells is provided in Table A below.

Table A: Groundwater Elevations and Depths in Monitoring Wells at the WDG

Well	Date	Ground Elevation (m asl)	Depth to Groundwater (m)	Groundwater Elevation (m asl)
GN1A	10/11/14	445.77	2.05	443.72
GN1B	10/11/14	445.77	5.43	440.34
MW2	10/11/14	445.77	1.75	444.02
MW3A	10/11/14	443.76	2.80	440.96
MW3B	10/11/14	443.76	1.24	442.52
MW4A	10/11/14	442.54	2.16	440.38
MW4B	10/11/14	442.54	1.31	441.23
MW5A	10/11/14	443.45	1.84	441.61
MW5B	10/11/14	443.45	1.38	442.07

From information provided by MWM, several of the wells were installed into deeper water bearing zones (GN1B, MW3A, MW4A and MW5A), while the remaining wells were installed at shallower depths. From the groundwater elevation data obtained from the site, the shallow groundwater flow was estimated to follow the surface grading toward the northwest direction, based on the assumption that groundwater is flowing from areas of higher elevation to areas of lower elevation. The groundwater elevations in the monitoring wells installed deeper did not vary greatly, however minor flow appeared to be towards the northwest (MW4A) and southeast (GN1B). It is not unusual for groundwater levels to fluctuate seasonally or annually, based on variable precipitation levels.

2.5.7 WDG Cell Liner Requirements

The *Manitoba Siting Guidelines for Class I WDG Sites* and the existing operating permit of the MWM facility both require a clay liner of a waste disposal cell to have a minimum thickness of 1.0 m and have a hydraulic conductivity of 1×10^{-7} cm/sec or less. If suitable soils are not available for this construction, then a synthetic geomembrane liner can also be utilized. This low level of permeability in the active cell liner is required to ensure that leachate or wastewater does not impact surrounding groundwater resources.

The design and construction of the petroleum contaminated soils area would be in accordance with the *Manitoba Treatment and Disposal of Petroleum Contaminated Soil* Guideline (January 2015), which requires that the cells be underlain with a synthetic liner or a minimum 0.5 m thick clay liner having a permeability of 1×10^{-7} cm/sec or less.

2.5.8 Contaminant Migration

The *Manitoba Siting Guidelines for Class I WDG Sites* describe the geological sensitivity of a site as being very high, high, moderate or low, based on the estimated vertical time of travel for liquid contaminants through the sub soils. Sites with a very high sensitivity would have an estimated time of travel of weeks to months until the contaminants reach the aquifer, while a site with a

low sensitivity would have an estimated time of travel of several decades to a century before the contaminants would reach the aquifer. This not only considers the permeability of the soils below the active area, but also the depth of the overburden soils prior to reaching the aquifer of concern.

Based on the estimate of vertical leachate flow below the waste disposal area, the worst case scenario would be a vertical flow of 0.13 m/year. The surficial groundwater was recorded at a shallowest elevation of 1.24 m below the surface, which is near the floor elevation of the excavated cell, however this groundwater bearing zone is not significant or utilized for potable water. The deeper water bearing zone is located below a layer of confining clay till at a depth of 31 m below the surface. Based on the vertical flow velocity, it would take approximately 150 years for leachate to reach this underlying water bearing zone. This would correspond to a geological sensitivity rating of low, defined by *Manitoba Siting Guidelines*.

2.5.9 Conceptual Design

2.5.9.1 Proposed Development

The proposed development is for the WDG expansion that will consist of constructing expansion cells for waste disposal and a contaminated soils pad. From a review of the projected waste generation, the initial expansion cell will be sized for a minimum of 10 years. The expansion cells would be located directly north and west of the existing waste disposal cells. The WDG expansion cells would be constructed for a minimum design life of 25 years based on the projected waste generation loadings, however changes in waste generation, waste diversion and population growth will impact this design life.

The contaminated soils pad will be sized based on available land in the expansion area of the site, without disturbing low lying sloughs with standing water. The contaminated soils pad should be utilized for the design life of the WDG, as the soils will be recycled as cover material once they are decontaminated. An area will also be designated for soil stockpiling of decontaminated soils and non-contaminated soils hauled to the site, for future use as cover material, as needed.

The internal site access road would be extended into the expansion areas to allow vehicle access to the expansion cells for waste drop off. The proposed waste disposal cells and access road would require perimeter ditching to connect with the existing ditching at the WDG site, in accordance with the site drainage plan. The raised dikes around the expansion cells, contaminated soils cell and leachate pond would prevent surface drainage from entering these areas. The proposed site layout of the expanded site is shown in Plans 2 and 3 of Appendix D.

Conditions of the Environment Act Licence would be met through the expansion works along with the site operations. Site operations would remain relatively the same, with regular compaction and covering of residential waste material in the

waste disposal cell, monitoring the liquid level in the leachate pond and regular mixing of the contaminated soils.

2.5.9.2 Storage Requirements

Based upon the projected waste generation rates for the site over 25 years, the expansion area within the WDG site boundaries would be utilized for several expansion cells and the contaminated soils pad. In a WDG, solid waste can be disposed of both below and above grade, depending on soil and groundwater conditions, minimizing the total surface area required for the waste disposal cells. The cell sizing herein is based on an average excavation of 2.0 m below the surface and the waste being extended to a height of approximately 4.0 m above the surrounding prairie grade. For sizing the expansion cells, the below grade side slopes were assumed to be 3H:1V, while the above grade portion of the cell would have side slopes of 5H:1V. The size of the expansion cells will be limited to the landscape, with cells constructed between and around the low lying ponds and wetlands. Therefore, the cells will be constructed with varying areas and shapes to accommodate these landscape features. The initial expansion cell, located to the west of the existing waste disposal cell and leachate pond, will have a flat bottom area of approximately 105 m x 289 m and will have a capacity of approximately 171,000 m³, which should be sufficient for a minimum of 10 years of waste loading. The expansion area will allow for a minimum overall storage capacity to design year 25.

The contaminated soils pad will have an area of approximately 6,800 m² (170 m x 40 m), and will be surrounded with a perimeter ditch on the interior of the perimeter berm for collection of contaminated runoff, and the perimeter berm constructed approximately 0.5 m above grade. As discussed in Section 2.5.9.8 below, with a soil layer 0.3 m thick, the pad would have capacity for approximately 2,040 m³ of contaminated soils.

2.5.9.3 Conceptual Liner Design

Based on the results of the onsite investigation and laboratory analysis, the layers of high plastic clay and silt till found throughout the potential expansion area would be suitable for use as a WDG cell liner and contaminated soils pad liner in an undisturbed, in situ state. The floor of the WDG expansion cells and contaminated soils pad would be in situ soil material, while the surrounding dikes of the expansion cells would be constructed of excavated and compacted high plastic soils from the cell excavations. The dikes would contain a 1.0 m thick vertical cutoff wall that would tie into the in situ floor liner. Any layers of low plastic silt and sand excavated would not be utilized in the liner construction, but would be suitable for use on the outer and inner dike or berm slopes. If a pocket or seam of unsuitable material or large rocks are discovered in the soil layer during construction, these unsuitable materials would be removed and replaced with suitable reworked soil material.

Based on requirements of Manitoba Conservation, both the vertical cut-off walls and horizontal floor liners would need to be constructed with a minimum thickness of 1.0 m in the expansion cells, and the horizontal liner for the contaminated soils pad constructed with a minimum thickness of 0.5 m.

2.5.9.4 Monitoring Wells

The WDG site has five existing monitoring wells located in the expansion area surrounding the existing active and decommissioned cells (see Plan 2 in Appendix D). As described in Section 2.5.6.4 above, the wells were installed in shallower and deeper water bearing zones. These wells may need to be replaced in the future as additional expansion cells are constructed but they should continue to be utilized for groundwater sampling after the construction of the initial expansion cell and contaminated soils area.

As the expansion cells, leachate pond and contaminated soils pad have been and will be constructed with proper soil liners, it is expected that leachate will be contained within the designated cells and will not contaminate groundwater. However, the existing groundwater monitoring wells will be continue to be sampled regularly to determine whether there are any impacts from the waste disposal activities.

The decommissioning and installation of monitoring wells in the future will be discussed with environment enforcement officers and Manitoba Conservation Approvals Branch as expansion requires.

2.5.9.5 Cover System

The active portion of the expansion cells are proposed to have a compacted layer of clean soil cover material (0.15 m thick) applied monthly. In sizing the expansion cells, it was assumed that the cover material will comprise approximately 20% of the total cell volume. Any additional soil material excavated from the cell construction would be stockpiled and utilized as soil cover material in future site operation.

Decontaminated soils can be utilized as soil cover material if they meet the soil quality requirements described in the CCME *Canadian Environmental Quality Guidelines* and *Canada-Wide Standards for Petroleum Hydrocarbons in Soil* for Industrial Land Use and the Manitoba Guideline 2002-02E: *Criteria for Acceptance of Contaminated Soil at Licensed Waste Disposal Ground*, as summarized in the table below:

Table B: Soil Quality Parameters for Use as Landfill Cover

Parameter	Maximum Acceptable Concentration (mg/kg)
Benzene	5.0
Toluene	14

Parameter	Maximum Acceptable Concentration (mg/kg)
Ethylbenzene	20
Xylene	21
PHC Fraction 1	660
PHC Fraction 2	1500
PHC Fraction 3	2500
PHC Fraction 4	6600
Arsenic	26
Benzo-a-pyrene	1.4
Ethylene glycol	1800
Pentachlorophenol	28
Phenol	128
Tetrachloroethylene	34
Thallium	3.6

Based on Manitoba Regulation 150/91 and the current operating permit for the site (No. 36924) all deadstock and SRM waste material would be covered by 1.0 m of soil within 24 hours of being dumped at the site.

2.5.9.6 Cell Closure

The active and expansion cells, when at the maximum height above ground as previously described, would be capped with 0.5 m of compacted clay type soil and topsoil, as prescribed in the Manitoba Conservation guidelines. The site will also need to be graded to provide positive drainage off of the site and seeded to provide an aesthetically pleasing natural environment upon closure. A maximum slope of 5H:1V would be utilized on decommissioned cell caps at the site.

2.5.9.7 Leachate Management System

As a requirement of Manitoba Regulation 150/91, and the *Waste Management Facilities Regulation*, leachate produced at a WDG needs to be contained within the boundaries of the WDG and should not contaminate groundwater. Leachate has a potential to be produced when decomposing waste material comes in contact with water, and occurs most frequently in an active residential waste disposal cell.

The WDG has an existing leachate collection system and leachate evaporation pond. Based on information provided by MWM, the floor of the existing waste disposal cell has leachate collection piping trenched into the floor, which flows by gravity to a sump pit located to the west of the active cell. The floor of the active cell is graded towards the collection piping and the sump pit is pumped out with a submersible pump and flexible hosing above ground into the leachate evaporation pond. This leachate management system shall continue to be utilized to collect and remove leachate generated from the existing active cell. The expansion cells will also be constructed with a perforated leachate collection piping installed in a trench in the

cell floor, and would flow by gravity into the sump pit (see Plan 3 in Appendix D).

To control leachate production, operation of the waste disposal cell would consist of dividing the active waste disposal cell into thirds. At any given time, 1/3 of the area of the waste disposal cell will be in use (i.e. accepting waste materials) and 2/3 will not be in use (i.e. capped with an impermeable clay cover or empty). The operator will divide the waste disposal cell by building a temporary berm that will divert clean runoff water away from the in-use portion of the cell to minimize leachate production. This temporary berm would be approximately 0.5 m high and prevent surface water from entering the active portion of the active cell. Any rainwater collected in the non-active portion of the active cell will be pumped out as required to the perimeter ditch by the site operator. Once the active portion of an active cell is filled with solid waste up to the level of the berm, the soil from the berm can be used as cover material and a new berm constructed at 2/3 the length of the cell. These stages of operation can be seen in Plan 6 of Appendix D.

The existing leachate evaporation pond is located immediately north of the existing active waste disposal cell (see Plans 2 and 3 in Appendix D). The leachate pond was constructed utilizing compacted clay material in the dikes and an in situ clay liner in the floor. Based on permeability testing conducted by Manitoba Conservation, the liner in the leachate pond achieved hydraulic conductivity values of 3.0×10^{-8} cm/sec and 8.8×10^{-9} cm/sec, which is within the provincial requirements for a leachate pond liner. The leachate pond was constructed with a maximum operating depth of 1.5 m and a freeboard height of 1.0 m from the maximum operating depth to the top of dike. The storage capacity of the leachate pond is estimated to be approximately 2,500 m³, from the floor to the maximum operating depth of 1.5 m.

It is anticipated that liquid in the leachate pond will evaporate over time and maintain a balanced liquid level, however liquid can build up in the pond depending on the amount of precipitation experienced in a given year. An estimation of leachate production was based on climate data provided by Environment Canada from 1981 to 2010, for precipitation and evapotranspiration near the WDG site. In addition, the size of the active portion of the proposed expansion cell and the capacity of the existing leachate pond were considered for storage and evaporation potential. Based on precipitation falling on a third of the expansion cell, the estimated annual leachate production would be 695 m³/year, while the anticipated evaporation rate from the leachate pond would be 526 m³/year. Therefore it is estimated that the existing leachate pond would fill to a maximum liquid level of 1.5 m in design year 15. If liquid in the pond builds up to a liquid level beyond the designed maximum liquid level (1.5 m), the local Manitoba Conservation environment enforcement officer should be contacted to determine the most appropriate course of action.

The WDG operator could reduce the volume of leachate generated further by dividing the expansion cell in a quarter, instead of a third. This would theoretically extend the

life of the existing leachate pond, however other factors such as field capacity (i.e. ability to absorb and retain liquid) of the soil and waste, and incoming moisture levels of the waste are difficult to predict, which will impact the leachate generation rate. It is therefore, more reasonable for the WDG operator to observe the annual volume of leachate generated for a few years and make any required adjustments to waste disposal cell operations as needed.

2.5.9.8 Contaminated Soils Area

The contaminated soils pad is proposed to be located to the west of the existing decommissioned waste disposal cells on the site (see Plans 2 and 3 in Appendix D). Based on the Manitoba *Treatment and Disposal of Petroleum Contaminated Soil* Guideline (January 2015), a clay liner with a minimum thickness of 0.5 m and a permeability of 1×10^{-7} cm/sec or less would be utilized as the pad liner in the contaminated soils area. This liner would be in situ (undisturbed) clay till located at an approximate depth of 1.5 m below the surface. The soil testing and analysis in the contaminated soils area indicated that this high plastic clay till has an in situ permeability of less than 1×10^{-7} cm/sec, and a minimum thickness of 4.5 m. A vertical cutoff wall of compacted medium plastic clay would tie into this in situ clay till material below, forming a continuous liner to contain contaminated liquids in the cell. In addition, a working surface of granular material would be utilized on the floor of the pad to distinguish the contaminated soils and pad floor during tilling or removal of the contaminated soil.

An above grade berm surrounding the pad would be constructed to a minimal height of 0.5 m above the surrounding prairie grade, to prevent surface run-off water from entering or leaving the area during a storm event. This perimeter berm would be constructed of excavated medium plastic clay till and silt material found below the topsoil, with 3H:1V slopes. The floor of the pad would be constructed with a typical gradient of 1% to 2% to facilitate surface drainage towards an internal drainage ditch around the perimeter of the pad but still within the boundaries of the perimeter berm (see Plan 4 in Appendix D).

The contaminated soil area will consist of several sectioned off areas, with cross berms, to segregate soils from separate loads over time. In this way soils which have been decontaminated at the site would not be mixed with new contaminated soils shipped to the site. The provincial guidelines recommend the contaminated soil either be laid flat on the pad to a maximum thickness of 0.3 m or in windrows with a maximum height of 1.0 m.

2.5.9.9 Drainage

The proposed perimeter ditching throughout the expansion area would drain to the surrounding existing ponds and wetland areas as indicated on Plan 3 of Appendix D. Perimeter ditching can also be directed to the existing ditch along Road 47 N, which

flows towards the west to PR 250.

2.5.9.10 Access Road

The existing all-weather access road to the WDG site (Road 47 N) is well maintained and will continue to be utilized for access to the site. From site observations, the interior roads accessing the compounds and cells will need to be extended into the expansion area and contaminated soils area utilizing compacted granular materials. Access to each of the proposed expansion cells will be required with truck turnaround areas at the proposed drop off locations. The proposed interior roads would have adequate width for two-way traffic and would be able to withstand heavy equipment traffic. The proposed road base would consist of compacted subgrade, geotextile, C base granular material and A base granular material (see Plan 5 in Appendix D).

2.5.9.11 Fencing and Signage

The proposed WDG expansion cells will be surrounded by 1.8 m high, movable fixed knot game fencing placed around the perimeter of the WDG to prevent windblown debris from leaving the site and to prevent unauthorized entry by humans or large animals. Plan 5 in Appendix D indicates the location of perimeter fencing.

Signs indicating drop off locations will be placed at the truck turnaround areas of the proposed waste disposal cells, and contaminated soils area. Warning signs should also be posted at the contaminated soils, asbestos and leachate retention pond areas for public health and safety.

2.5.10 Construction Techniques

The reworked soils forming the vertical cut-off walls are to be constructed to a minimum width of 1.0 m, however to accommodate typical construction equipment and vehicle access requirements it is assumed that the cut-off wall will have a minimum width of 3.0 m. The cut-off wall would extend to a depth of 1.0 m below the horizontal liner elevation. For the purpose of sizing the site, the active cell floor elevation for each of the waste disposal cells will have an average depth of approximately 2.0 m below the average surface elevation in the expansion area. Details of the dike and liner construction are shown on Plan 4 in Appendix D.

For dike and liner construction, the excavated material is to be compacted with to a minimum Standard Proctor Density of 98%, in lifts of 150 mm. The dike and liner material should be compacted with a minimum of eight passes of a sheepsfoot roller on each 150 mm lift. A limited range of moisture content will be permitted during construction. The material shall not be so wet nor so dry that compaction equipment cannot compact the fill into a homogeneous mass. Material too wet shall be dried or wasted and material too dry shall be wetted. The cell floor will be graded with a slope of 1% to 2% towards the leachate collection piping. The inner and outer dikes would be constructed with a mixture of excavated soil material (clay, silt, topsoil).

The construction specifications should indicate that the sheepsfoot roller shall have a minimum foot pressure of no less than 1,700 kPa (250 psi). The drum diameter of the sheepsfoot roller should not be less than 1,200 mm. Each roller should be equipped with cleaning fingers designed to prevent the accumulation of material between the tamping feet. The foot pressure would be calculated by taking the total mass of the roller and dividing it by the greater of: the area of the maximum number of tamping feet in one row parallel to the axis of the roller, or by 5% of the total foot area. The roller feet should be at least 200 mm long and should have a minimum area of at least 4,500 mm².

2.5.11 Decommissioning and Closure

The proposed waste disposal cells, when at maximum height above ground, will be decommissioned by covering with a minimum of 0.5 m compacted clay soil and topsoil as per *Manitoba Conservation Siting Guidelines* and Reg. 150/91. The surface of the capped cells will be graded to allow positive drainage away from the site. The site will be seeded with grass to provide an aesthetically pleasing environment, and regular monitoring of the site will continue to occur to determine if there are any impacts to groundwater at the site. The monitoring wells should be sampled and tested on a regular basis for the baseline water chemistry parameters as prescribed by the Environment Act Licence.

The final contours of the finished cells are proposed to be such that they will have a maximum finished elevation of approximately 4.5 m above the original average prairie grade. The outside slopes of the capped cells should be a minimum of 5H:1V. The final contour of the cells will assist in minimizing infiltration of water, preventing surface water ponding and retaining slope stability. A top layer of organic soils seeded with grass will be placed to provide a vegetative cover that will further reduce the potential for erosion by wind or surface run-off, and reduce infiltration of precipitation through evapotranspiration.

Decommissioning of the contaminated soils pad will include removing PHC treated soil and testing the soils in the floor of the pad for PHC contamination. Any PHC contaminated soils in the cell would be aerated, treated and used as cover material. The cell would be capped with topsoil, re-graded to original grade and seeded with grass.

2.5.12 WDG Maintenance and Operation

2.5.12.1 General Site Operation and Maintenance

The WDG site has designated and trained operators to handle the following tasks:

- collecting tipping fees at the gate entrance
- recording waste quantities dropped off at the site
- directing the public to the appropriate drop off locations
- moving, covering and compacting waste material in the active waste disposal cell regularly
- inspecting and maintaining the fencing, gate and lock

- inspecting and maintaining WDG heavy equipment
- keeping drainage ditches free of debris
- ensuring the entrance gate is locked at all times when the operators are not present
- ensuring contaminated soil is mechanically mixed regularly
- ensuring the liquid level in the sump pit and leachate evaporation pond is maintained at an acceptable height
- ensuring recyclable materials are hauled off site regularly and that compounds do not reach capacity
- ensuring that unacceptable waste products are not dumped at the site
- ensuring internal access roads are cleared and maintained regularly
- ensuring windblown waste material is cleaned up regularly.

2.5.12.2 Contaminated Soils Area Operation and Maintenance

The operator is to maintain a record of the PHC contaminated soils received at the site, including the origin, volume, contaminant type and concentration. It is expected that contaminated soils will be spread in an even layer over the compacted pad to a maximum thickness of 0.3 m and mechanically mixed with tilling or aerating equipment regularly. Alternatively, the contaminated soils could be placed in windrows to a maximum height of 1.0 m and also mechanically mixed and aerated regularly. Typical mixing frequency is every one to two weeks for effective treatment. Soil wetting can be conducted with water accumulated within the contaminated soils cell, if dust production becomes a nuisance.

The operator will also construct and maintain separation berms within the cell to separate loads of PHC soil from different locations or time periods. It is difficult to estimate the length of the treatment period required, as it is based on the concentration of volatile organics in the contaminated soils when received at the site, frequency of mixing and environmental conditions during the treatment period.

Typically, the contaminated soils should be tested at the end of the summer period to determine whether the material can be utilized as cover material in the waste disposal cell. Soil samples should be collected in a grid pattern across the contaminated soil layer in specified laboratory containers for BTEX analysis. The number of samples required would be based on the Manitoba Guideline: *Treatment and Disposal of Petroleum Contaminated Soil* [January 2015].

3.0 POTENTIAL ENVIRONMENTAL IMPACTS

The biophysical and socioeconomic environment as related to the development, and potential impacts of the development on the environment.

3.1 Releases to Air, Water, Land

3.1.1 Air

Prevailing winds in the area can carry odours if the waste disposal areas are exposed and wind breaks are not utilized around the site. These odours have the potential to be a nuisance to nearby residents.

There is also a potential for greenhouse gas emissions during construction and operation works from heavy equipment and transport vehicles. As heavy equipment is currently utilized daily from site operations, there would only be a minor increase during the construction works, with additional heavy equipment on site. Impacts from dust generation are not expected to be significant as the construction area will meet the minimal setback distances from residences to reduce the likelihood of dust being a nuisance.

3.1.2 Water

Pollutants that have the potential to be released into surface water and groundwater during the operation of WDG would be from leachate production. Pollutants potentially produced in waste disposal cells would generally include nutrients, coliforms, volatile organics, suspended solids, heavy metals, inorganic compounds and organic carbons that are typical for leachate produced from residential wastes. Pollutants potentially produced in contaminated soils leachate would include volatile organics.

Pollutants that have a potential to be released into the surface water or groundwater during the WDG upgrade and expansion construction activities, would include petroleum hydrocarbons (PHCs) from heavy equipment spills/leaks and sediments from soil erosion.

3.1.3 Land

The native landscape is characterized by numerous ponds and sloughs, along with productive agricultural land. The landscape would be altered by construction of expansion cells which will extend approximately 5.5 m above the surrounding grade. Perimeter dikes, ditching and fencing would also be constructed/installed around the perimeter of the expansion cells and contaminated soils pad. Leachate and windblown litter can impact surrounding lands if not contained. Ground areas disturbed by construction activities can be impacted through soil erosion if not covered or re-vegetated shortly after works are completed.

Pollutants that may be released to the land are predominantly PHCs, which could be released during construction activities from equipment leaks, and/or re-fuelling incidences and could result in impacts to the soils/land.

3.2 Wildlife

The WDG site is located in the “Aspen Parkland” Ecoregion of Canada. Characteristic wildlife includes: white-tailed deer, red fox, northern pocket gopher, ground squirrel, coyote, snowshoe hare, and cottontail. Bird species include waterfowl, sharp-tailed grouse and black-billed magpie. Wildlife common at landfill sites include rodents, gulls and crows. No wildlife other than gulls and crows were observed at the site during the site investigation.

The typical concern on any construction project is that wildlife species would be displaced through the construction works. However, from observations made during the site investigation it is unlikely that the construction works will have any impact on wildlife or wildlife habitat in the area, as the development site is cleared sections of land adjacent to active waste disposal cells and surrounding farming activities. In addition, the expansion cells and expansion areas were laid out with consideration of the natural ponds and wetlands on the WDG property, therefore these natural low-lying sloughs should not be removed or damaged by the construction activities. These sloughs provide habitat for waterfowl and small amphibians.

In addition, the Manitoba Conservation Data Centre and Wildlife and Ecosystem Protection Branch were contacted regarding occurrences of rare or endangered wildlife and bird species in their database for the proposed expansion area. The response indicated there were no occurrences of rare species identified in the area of the proposed development, based on information in the provincial database (see email correspondence attached in Appendix B).

3.3 Fisheries

The typical concerns with impacts to fish and fish habitat are from sediments released during construction and the leachate discharges into a body of surface water utilized by fish species. These impacts could include the reduction of water quality or physical disturbances that would create an unfavorable environment for fish or fish eggs.

As the nearest body of surface water potentially containing fish species is located approximately 4.5 km away, the potential for any impacts from the WDG site is very low. The site would be designed to contain leachate and siltation off of the site would be controlled.

3.4 Forestry

The area of the WDG expansion is a cleared parcel of land, therefore no potential impacts to forestry in the area are expected, as tree removal will be minimal and the area is not commercially forested.

3.5 Vegetation

Characteristic vegetation in the “Aspen Parkland” Ecoregion is a mixture of farmland and transitional boreal forest with grassland. The native landscape is characterized by trembling aspen, oak groves, mixed tall shrubs and intermittent fescue grasslands. During the site investigation the only native

vegetation observed were native grasses, bulrushes and reeds were observed in the low lying sloughs, while some tall shrubs were located along the perimeter.

The typical concern on any construction project is the removal of vegetative species through the construction works, however as the expansion area has been cleared of trees there will be a minimal loss of native vegetation. The majority of the vegetative species to be removed will be native grasses and the loss of agricultural cereal crops from the expansion area. Manitoba Conservation Wildlife and Ecosystem Protection Branch was contacted regarding occurrences of rare or endangered vegetative species in their database for the proposed expansion area. The response indicated that there were no occurrences of rare species identified at the proposed development site (see email correspondence attached in Appendix B).

3.6 Noise Impacts

There is a potential for noise impacts in the immediate area of expansion cells due to the heavy equipment utilized during construction, however these impacts are not expected to be significant, as heavy equipment is already being used at the site during daily maintenance. Noise impacts are not expected to become a nuisance to residents due to the setback distances described above. No additional noise impacts are expected during operation of the expanded and upgraded WDG as no additional maintenance equipment will be utilized.

3.7 Health and Safety

There is a potential for impacts to the health and safety of workers and the public during the construction works, as heavy equipment will be utilized on site while the public has access to other areas of the WDG.

3.8 Heritage Resources

The MWM was not aware of any historic, traditional or heritage resources located at the proposed expansion area. The Manitoba Historic Resources Branch was contacted regarding the proposed expansion area, however they provided no response to the presence of any previously recorded heritage sites in the area of development. Given the nature of the site it is unlikely that any heritage resources will be impacted by the proposed works.

While impacts to historic or heritage resources are not expected at the site, there is always potential for an unexpected discovery when excavating an area that has not recently been excavated.

3.9 Socio-Economic Implications

The WDG expansion is not expected to have adverse socio-economic impacts. In fact, construction of expansion cells and a contaminated soils pad is expected to have a positive economic impact on MWM, as it will provide an additional source of income. In addition, the service area will have a local option for depositing contaminated soils upon completion of the construction works.

Traffic along Road 47 N would increase minimally from heavy construction equipment travel to and from the WDG site during construction, however no impacts from traffic are expected during operation of the upgraded and expanded site. There is also room on the site for parking construction equipment and

transport vehicles, therefore traffic should not be impacted while onsite or while travelling to the site, due to parked equipment/vehicles.

3.10 Aesthetics

The WDG expansion and upgrade will have an impact on the general aesthetics of the area, as the WDG expansion cells would replace existing agricultural land and be extended to approximately 5.5 m above the surrounding grade. The works would occur adjacent to Road 47 N, however this is not a main through road in the area and therefore impacts to residents and visitors in the area would be minimal. Windblown litter is also a concern at WDG sites as it creates a site which can be aesthetically unpleasing.

4.0 MANAGEMENT PRACTICE

Proposed environmental management practices to be employed to prevent or mitigate adverse implications from the impacts identified above.

4.1 Mitigation of Impacts to Air

To reduce the potential for nuisance odour impacts, the upgrade and expansion will be located beyond the minimum setback distances to nearby rural and community residents. While there is potential for odours at the WDG site during operation, the WDG property is located approximately 900 m from the nearest rural resident and 3.6 km from the nearest community. Therefore, based on these distances the likelihood of odours impacting these surrounding residents is low. In addition, with regular waste cover material being utilized and proper operation of the contaminated soils, odours are not likely to become a nuisance.

Municipal Waste Management is also encouraged to plant trees along the perimeter of the property to provide a better windbreak and visual barrier.

Emissions from construction equipment and transport vehicles will be controlled through regular maintenance by the contractor and operator, and should meet all provincial and local emission standards. Dust suppression methods (i.e. water spraying) can be utilized at the construction site if dry conditions create excessive dust through construction activities and transport, and becomes a nuisance to nearby residents.

4.2 Mitigation of Impacts to Water

Impacts to surface waters and groundwater from leachate production will be reduced by the construction of soil cell liners, meeting the permeability requirements by Manitoba Conservation, for the expansion cells and contaminated soils pad. The existing waste disposal cell and leachate retention pond have also been constructed with suitable clay liners meeting requirements of Manitoba Conservation. Discharge of leachate from waste disposal cells and evaporation ponds are not typically permitted at WDG sites by Manitoba Conservation. Leachate produced will be contained in the evaporation pond and in the waste disposal cells and will be dissipated through natural evaporation.

Siltation in surrounding ponds and sloughs from disturbed soil areas during the construction works, will be mitigated through the use of silt fencing along the shore of the ponds/sloughs. Exposed dike and ditch slopes would be seeded with grass to control erosion.

To minimize impacts from equipment leaks or spills, the construction contractor and or WDG operator will be responsible for maintaining heavy equipment to prevent leaks and spills of fuels, lubricants, hydraulic fluids or coolants. In addition, construction specifications should outline to the construction contractor the requirements for handling and storage of fuels and hazardous materials during construction, as per federal and provincial regulations. The construction specifications should state wording similar to the following:

- Diesel or gasoline should be stored in double walled tanks or have containment dikes around fuel containers for volumes greater than 68.2 L (15 gallons) or in compliance with provincial regulations
- Clean up material should be available at the site, consisting of a minimum of 25 kg of suitable commercial sorbent, 30 m² of 6 mm PVC, and an empty fuel barrel for spill collection and disposal
- Fuel storage and hazardous material areas established for project construction should be located a minimum of 100 m from a waterbody or drainage route
- There can be no re-fueling or servicing of construction equipment within 100 m of a water body or drainage route
- Waste hazardous materials from construction activities and equipment must be properly collected and disposed of in compliance with provincial regulations
- In the event of spills or leaks of fuels and hazardous materials, the contractor or operator should notify the project engineer and provincial authorities (Manitoba Conservation at (204) 944-4888)
- Hazardous material handling and storage are to follow all provincial and federal regulations including WHMIS and spill containment requirements.

4.3 Mitigation of Impacts to Land

To minimize impacts to the surrounding land, containment dikes and fencing around the expansion cells and contaminated soils pad will act to contain leachate and windblown litter to the designated areas. Regular cover also acts to prevent windblown litter and the production of leachate in the waste disposal cells. Disturbed ground surface areas will be seeded upon completion of construction works to minimize soil erosion. To minimize the potential for slope erosion, the outer dike slopes would be seeded with grass upon completion of construction. To minimize the potential for the release of PHCs into the soil, the mitigation measures described in Section 4.2 above, outlining equipment maintenance and fuel-handling procedures, should be followed.

4.4 Mitigation of Noise Impacts

To minimize the potential for noise impacts, construction equipment and transport vehicles should have mufflers working properly, and construction activities would be limited to daylight hours only.

4.5 Mitigation of Impacts to Health and Safety

To minimize impacts to health and safety of workers and the public, the construction contractor should have a safety program in place, in accordance with all federal and provincial health and safety regulations. During construction, access to the construction areas will be limited to the construction crew only. Personal protective equipment will be worn by construction crew in accordance with the contractor's safety program, while in the construction area. During operation of the site, access to the active face of the waste disposal cell will be limited to WDG staff only.

4.6 Mitigation of Impacts to Heritage Resources

If any significant historic or heritage resources are discovered in the course of excavation or construction, the specifications should identify that works are to temporarily cease and an investigation of the site is to be conducted by MWM, Manitoba Historic Resources Branch and any other provincial or federal authority as may be required.

4.7 Aesthetics

Impacts to aesthetics at the WDG site would be mitigated by seeding disturbed slopes and cleaning up windblown litter as part of the regular WDG operations. Municipal Waste Management is also encouraged to plant trees along the perimeter of the WDG property to reduce the visual impacts of expansion waste disposal cells.

5.0 RESIDUAL AND CUMULATIVE EFFECTS

Residual environmental effects remaining after the application of mitigation measures, to the extent possible expressed in quantitative terms relative to baseline conditions

No negative residual effects are anticipated through the WDG expansion construction and operation, due to the mitigation measures described above. Positive residual effects to MWM and the surrounding service population are expected from the increased waste disposal capacity and contaminated soil treatment capabilities, which will allow for continued growth of the service population.

Cumulative effects from other construction projects in the area are not anticipated as no other construction projects in the area are being planned.

Cumulative effects from operations of several waste disposal cells at once are not expected, as the expansion cells would only be constructed when existing waste disposal cells are nearing capacity, to reduce overlap of cell use.

6.0 MONITORING AND FOLLOW-UP

Proposed follow-up activities that will be required at any stage of development (eg. Monitoring, inspection, surveillance, audit, etc.)

The expansion cell, and contaminated soil pad liners would be inspected and tested in the presence of Manitoba Conservation, upon completion of construction works and prior to commissioning. The liners would be tested for hydraulic conductivity to ensure that the requirements of the Environment Act Licence are met.

Long-term monitoring on the WDG site would include regular testing of the groundwater monitoring wells for water quality parameters as described in the Environment Act Licence. Monitoring would also include testing the soil qualities of the contaminated soils after treatment to determine whether sufficient treatment has occurred.

The operator is also to ensure that the liquid level in the sump pit does not reach the surface before being pumped to the leachate evaporation pond. The operator would also ensure the liquid level in the leachate pond is maintained at an acceptable height, so that the freeboard is maintained and liquid does not overflow the cell. The operator is also to maintain records of type and quantity of waste received at the site. If there are any concerns with the operation of the WDG or with possible groundwater contamination, MWM is to contact the local environment officer and the Environmental Approvals Branch of Manitoba Conservation to discuss options. The construction contractor is to ensure that grass growth occurs on slopes and disturbed areas, after the construction activities are completed.

7.0 FUNDING AND APPROVALS

Name and address of any Government Agency or program (federal, provincial or otherwise) from which a grant or loan of capital funds have been requested (where applicable). Other federal, provincial or municipal approvals, licences, permits, authorizations, etc. known to be required for the proposed development, and the status of the project's application or approval.

Funding for this project would be provided privately by MWM. Variances from Manitoba Conservation and Water Stewardship would be required for setback distances to a surface water body and public road right of way, as described in Section 2.5.3 above. The Souris-Glenwood Industrial Air Park Airport should be informed of the expansion works. During the construction works, Manitoba Hydro and MTS will need to be contacted to notify of the proposed works and to locate any buried utility lines. No additional approvals, licences or permits, beyond the Environment Act Licence, are expected for the WDG expansion construction and operation works.

8.0 PUBLIC CONSULTATION

Results of any public consultations undertaken or to be undertaken in conjunction with project planning.

Public consultation by MWM through a designated public forum, has not been conducted to date for the residents in the service area, nor is public consultation being planned, as the site is privately owned and operated and is not likely to impact the surrounding public. Public comments received by Manitoba Conservation through the public registry during the Environmental Act Proposal review period will be addressed prior to the WDG expansion works.

9.0 CONCLUSION

Based on the design of the project and the implementation of the mitigation measures identified in Section 4.0 above, no significant negative environmental impacts are anticipated.

The proponent would like to complete the requirements of the Environment Act Proposal as soon as possible so that the WDG expansion construction works can begin in a timely manner.

JR Cousin Consultants Ltd. requests that a draft copy of the Environment Act Licence be forwarded for review prior to the issue of the final licence.

APPENDIX

Appendix A

Certificate of Title

Crown Lands & Property Agency - Lands Branch, September 17, 2015 Email Correspondence

Appendix B

Table 1: Waste Generation Projections – Municipal Waste Management

Manitoba Conservation and Water Stewardship - Wildlife and Ecosystem Protection Branch, October 23, 2015
Email Correspondence

Appendix C

Test Hole Logs

AMEC Foster Wheeler Environment and Infrastructure – Soils Analysis Report, October 28, 2015

Driller Well Log Reports

Appendix D

Title Page

Plan 1: Site Location Plan with Required Setbacks

Plan 2: Waste Disposal Ground Site with Test hole Location Plan

Plan 3: Proposed Waste Disposal Ground Expansion Layout and Drainage Plan

Plan 4: Dike, Liner and Leachate Pipe Details

Plan 5: Road, Ditch, Fence, Sign and Silt Fence Details

Plan 6: Site Operations Plan

Appendix A

Certificate of Title

Crown Lands & Property Agency - Lands Branch, September 17, 2015 Email Correspondence

Certificate of Title

Address For Service

Box 84
Goodlands MB ROM ORO

MANITOBA

Certificate of Title

UNDER THE REAL PROPERTY ACT

Cert. No. 221236

District Of Brandon

Sworn Value: \$ 68,000.00
Consideration: \$ 68,000.00

From Title: 146550 a11
Instrument No.: 95-8617

MUNICIPAL WASTE MANAGEMENT LTD.

is registered owner, subject to such entries recorded hereon, in the following described land,

SW $\frac{1}{4}$ 35-8-21 WPM.

Signed by me this 9th day of August 1995.

For the  District Registrar

New C.T. Number For the District Registrar

Type	Instrument Number	Date	Land Transferred To

PHOTOCOPY MADE ~~AUG 9 1995~~
NOT A DUPLICATE ORIGINAL

Crown Lands & Property Agency - Lands Branch, September 17, 2015 Email Correspondence

Oswald Wohlgemut

From: Little, Karen (CLPA) [Karen.Little@gov.mb.ca]
Sent: Thursday, September 17, 2015 8:57 AM
To: 'Oswald Wohlgemut'
Subject: RE: Municipal Waste Management Ltd. - Mineral Rights SW 35-8-21 WPM

Good morning Oswald – according to The Crown Land Registry this date:

The Dominion of Canada granted SW 35-8-21 WPM to Henry Douglas and Joy Wilder in 1888 along with the mines & minerals and sand & gravel. The Crown kept no ownership to the under-rights.

→ You provided a copy of Certificate Title 221236 that was provided by Land Titles Office in 1995, based on this copy the title is silent as to the exceptions and therefore reverts to how the land was originally granted therefore ownership of the mines & minerals and sand & gravel remained with this surface title. This may not be a current title as it was provided in 1995, I would suggest you request a current copy of the title for SW 35-8-21 WPM to ensure nothing has changed since 1995.

Sincerely,
Karen Little
Supervisor of Crown Lands Registry

Crown Lands and Property Agency
308 - 25 Tupper Street North
Portage la Prairie MB R1N 3K1
P 204-239-3805 F 204-239-3560
Toll Free 1-866-210-9589
karen.little@gov.mb.ca



An Agency of the Manitoba Government

The information contained in this e-mail and all attachments is confidential and is for the sole use of its intended recipient. It may not be disclosed to or used by anyone other than the addressee. If received in error, please contact the sender by return e-mail and delete this e-mail and all attachments from your system.

Le présent courrier électronique (courriel) et les documents qui y sont attachés peuvent contenir de l'information confidentielle; ils s'adressent exclusivement au destinataire mentionné ci-dessus et nulle autre personne ne doit en prendre connaissance ni les utiliser ou les divulguer. Si vous recevez le présent courriel par erreur, veuillez en aviser l'émetteur immédiatement par courrier électronique et le détruire avec les documents qui y sont attachés.

From: Oswald Wohlgemut [<mailto:owohlgemut@jrcc.ca>]
Sent: September-16-15 5:00 PM
To: Little, Karen (CLPA)
Subject: Municipal Waste Management Ltd. - Mineral Rights SW 35-8-21 WPM

Hello Karen,

JR Cousin Consultants Ltd. is submitting an Environmental Act Proposal on behalf of Municipal Waste Management, regarding the construction of new waste disposal expansion cells the Municipality of Souris-Glenwood, MB in SW 35-8-21 WPM. We have attached a copy of the certificate of title provided by the owner for the parcel of land proposed in the development. Could you confirm the ownership of the mineral rights?

Let me know if you have any questions.

Regards,

Oswald Wohlgemut, M.Sc.
Environmental Scientist

J.R. Cousin Consultants Ltd.

Phone: (204) 489-0474

Fax: (204) 489-0487

www.jrcc.ca

The information contained in this email and any attachments is privileged, confidential and subject to copyright. It is intended solely for the use of the person(s) to whom it is addressed. If you receive this email in error, please notify the sender by return email and permanently delete it from your system. Note: We have taken precautions against viruses, but take no responsibility for loss or damage caused by any virus present.

Appendix B

Table 1: Waste Generation Projections – Municipal Waste Management

Manitoba Conservation and Water Stewardship - Wildlife and Ecosystem Protection Branch, October 23, 2015
Email Correspondence

Table 1: Waste Generation Projections – Municipal Waste Management

TABLE 1
WASTE GENERATION PROJECTIONS
Municipal Waste Management

Column 1	Column 2	Column 3	Column 4	Column 5	Column 6	Column 7	Column 8
CALENDAR YEAR	PROJECT YEAR	TOTAL WASTE GENERATION (Residential, Commercial, Industrial) (tonnes / year)	TOTAL WASTE GENERATION (SRM, Deadstock) (tonnes / year)	TOTAL WASTE GENERATION (Combined Waste Material) (tonnes / year)	TOTAL WASTE TO DISPOSAL SITE (Residential, Commercial, Industrial) (m3 / year)	TOTAL WASTE TO DISPOSAL SITE (SRM, Deadstock) (m3 / year)	TOTAL WASTE TO DISPOSAL SITE (Combined Waste Material) (m3 / year)
2015	0	5525	294	5,819	11,631	294	11,925
2016	0	5663	302	5,964	11,922	302	12,223
2017	1	5804	309	6,114	12,220	309	12,529
2018	2	5950	317	6,266	12,525	317	12,842
2019	3	6098	325	6,423	12,839	325	13,163
2020	4	6251	333	6,584	13,159	333	13,492
2021	5	6407	341	6,748	13,488	341	13,830
2022	6	6567	350	6,917	13,826	350	14,175
2023	7	6731	358	7,090	14,171	358	14,530
2024	8	6900	367	7,267	14,526	367	14,893
2025	9	7072	377	7,449	14,889	377	15,265
2026	10	7249	386	7,635	15,261	386	15,647
2027	11	7430	396	7,826	15,642	396	16,038
2028	12	7616	406	8,021	16,034	406	16,439
2029	13	7806	416	8,222	16,434	416	16,850
2030	14	8001	426	8,428	16,845	426	17,271
2031	15	8202	437	8,638	17,266	437	17,703
2032	16	8407	448	8,854	17,698	448	18,146
2033	17	8617	459	9,076	18,140	459	18,599
2034	18	8832	470	9,302	18,594	470	19,064
2035	19	9053	482	9,535	19,059	482	19,541
2036	20	9279	494	9,773	19,535	494	20,029
2037	21	9511	506	10,018	20,024	506	20,530
2038	22	9749	519	10,268	20,524	519	21,043
2039	23	9993	532	10,525	21,037	532	21,569
2040	24	10243	545	10,788	21,563	545	22,109
2041	25	10499	559	11,058	22,102	559	22,661

Overall Total (tonnes): **208,824**

Overall Totals (m3): **417,404** **10,557** **427,961**

Compaction Rate (Residential, Commercial, Industrial): **475** kg/m3

Compaction Rate (SRM, Deadstock): **1,000** kg/m3

Manitoba Conservation and Water Stewardship - Wildlife and Ecosystem Protection Branch, October 23, 2015
Email Correspondence

Oswald Wohlgemut

From: Friesen, Chris (CWS) [Chris.Friesen@gov.mb.ca]
Sent: Friday, October 23, 2015 9:16 AM
To: 'Oswald Wohlgemut'
Subject: RE: Municipal Waste Management - Species at Risk

Oswald

Thank you for your information request. I completed a search of the Manitoba Conservation Data Centre's rare species database and found no occurrences at this time for your area of interest.

The information provided in this letter is based on existing data known to the Manitoba Conservation Data Centre at the time of the request. These data are dependent on the research and observations of CDC staff and others who have shared their data, and reflect our current state of knowledge. **An absence of data in any particular geographic area does not necessarily mean that species or ecological communities of concern are not present;** in many areas, comprehensive surveys have never been completed. Therefore, this information should be regarded neither as a final statement on the occurrence of any species of concern, nor as a substitute for on-site surveys for species as part of environmental assessments.

Because the Manitoba CDC's Biotics database is continually updated and because information requests are evaluated by type of action, any given response is only appropriate for its respective request. Please contact the Manitoba CDC for an update on this natural heritage information if more than six months pass before it is utilized.

Third party requests for products wholly or partially derived from Biotics must be approved by the Manitoba CDC before information is released. Once approved, the primary user will identify the Manitoba CDC as data contributors on any map or publication using Biotics data, as follows as: Data developed by the Manitoba Conservation Data Centre; Wildlife Branch, Manitoba Conservation and Water Stewardship.

This letter is for information purposes only - it does not constitute consent or approval of the proposed project or activity, nor does it negate the need for any permits or approvals required by the Province of Manitoba.

We would be interested in receiving a copy of the results of any field surveys that you may undertake, to update our database with the most current knowledge of the area.

If you have any questions or require further information please contact me directly at (204) 945-7747.

Chris Friesen
Coordinator
Manitoba Conservation Data Centre
204-945-7747
chris.friesen@gov.mb.ca
<http://www.gov.mb.ca/conservation/cdc/>

From: Oswald Wohlgemut [<mailto:owohlgemut@jrcc.ca>]
Sent: October-14-15 11:50 AM
To: Friesen, Chris (CWS)
Subject: Municipal Waste Management - Species at Risk

Hello Chris,

J.R. Cousin Consultants is preparing an Environment Act Proposal on behalf of Municipal Waste Management for the expansion of the existing waste disposal ground. The construction works will occur on SW 35-8-21 WPM (see attached plan). The expansion area is cleared and currently maintained as agricultural land with scattered low lying ponds/wetlands. Removal of these ponds/wetlands is not being proposed and tree removal will not be required for the

construction works. The WDG site is also surrounded by agricultural land. Works will include expansion cell construction, fence installation and ditch construction.

Please provide information on any at risk wildlife and plant species that are known to exist in the location outlined above, as well as any registered habitat areas, or known migrating bird species as we would like to include that information in the EAP.

Please let us know if you have any questions.

Thank you,

Oswald Wohlgemut, M.Sc.
Environmental Scientist

J.R. Cousin Consultants Ltd.
Phone: (204) 489-0474
Fax: (204) 489-0487
www.jrcc.ca

The information contained in this email and any attachments is privileged, confidential and subject to copyright. It is intended solely for the use of the person(s) to whom it is addressed. If you receive this email in error, please notify the sender by return email and permanently delete it from your system. Note: We have taken precautions against viruses, but take no responsibility for loss or damage caused by any virus present.

Appendix C

Test Hole Logs

AMEC Foster Wheeler Environment and Infrastructure – Soils Analysis Report, October 28, 2015

Driller Well Log Reports

Test Hole Logs

J. R. Cousin Consultants Ltd.
TEST HOLE LOGS

SYMBOL INDEX



GW. : Well graded gravels and gravel sand mixtures, little or no fines



GP. : Poorly graded gravels, gravel - sand mixtures,
little or no fines



GM. : Silty gravels, gravel-sand-silt mixtures



GC. : Clayey gravels, gravel-sand-clay mixtures



SW. : Well graded sands, gravelly sands, little or no fines



SP. : Poorly graded sands, or gravelly sands, little or no fines



SM. : Silty sands, sand-silt mixtures



SC. : Clayey sands, sand-clay mixtures



ML. : Inorganic silts and very fine sands, rock flour, silty or clayey fine sands,
or clayey silts with slight plasticity



CL. : Inorganic clays of low plasticity, gravelly clays, sandy or silty
clays, lean clays



OL. : Organic silts and organic silty clays of low plasticity



CI. : Inorganic clays of medium or intermediate plasticity



MH. : Inorganic silts, fine sandy or silty soils



CH. : Inorganic clays of high plasticity, fat clays



OH. : Organic clays of medium to high plasticity, organic silts



Pt. : Peat, humus, swamp soils with high organic contents



TOPSOIL

The soil logs are based upon objective data available to us at the time of forming our opinions. The soil logs indicate site specific soil characteristics and must not be generalized over larger areas due to the limited number of test holes as compared to that of an unlimited number of test holes. Every effort is made to evaluate the information by methods generally recognized. The soil logs represent our opinions. J. R. Cousin Consultants Ltd. cannot be responsible for actual site conditions proved to be materially at variance from our analysis or from the data generalization over untested areas.

J. R. Cousin Consultants Ltd.

TEST HOLE LOG SHEET

LOCATION : SW 35-8-21 WPM

CODE : N-324.02

DATE : SEPTEMBER 9, 2015

COORDINATES: N 5505683, E 411433

ELEVATION : 444.56m

METHOD OF SAMPLING : Drill Rig

PROJECT : Municipal Wastewater Management, WDG Expansion EAP

TEST HOLE # 1

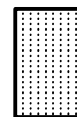
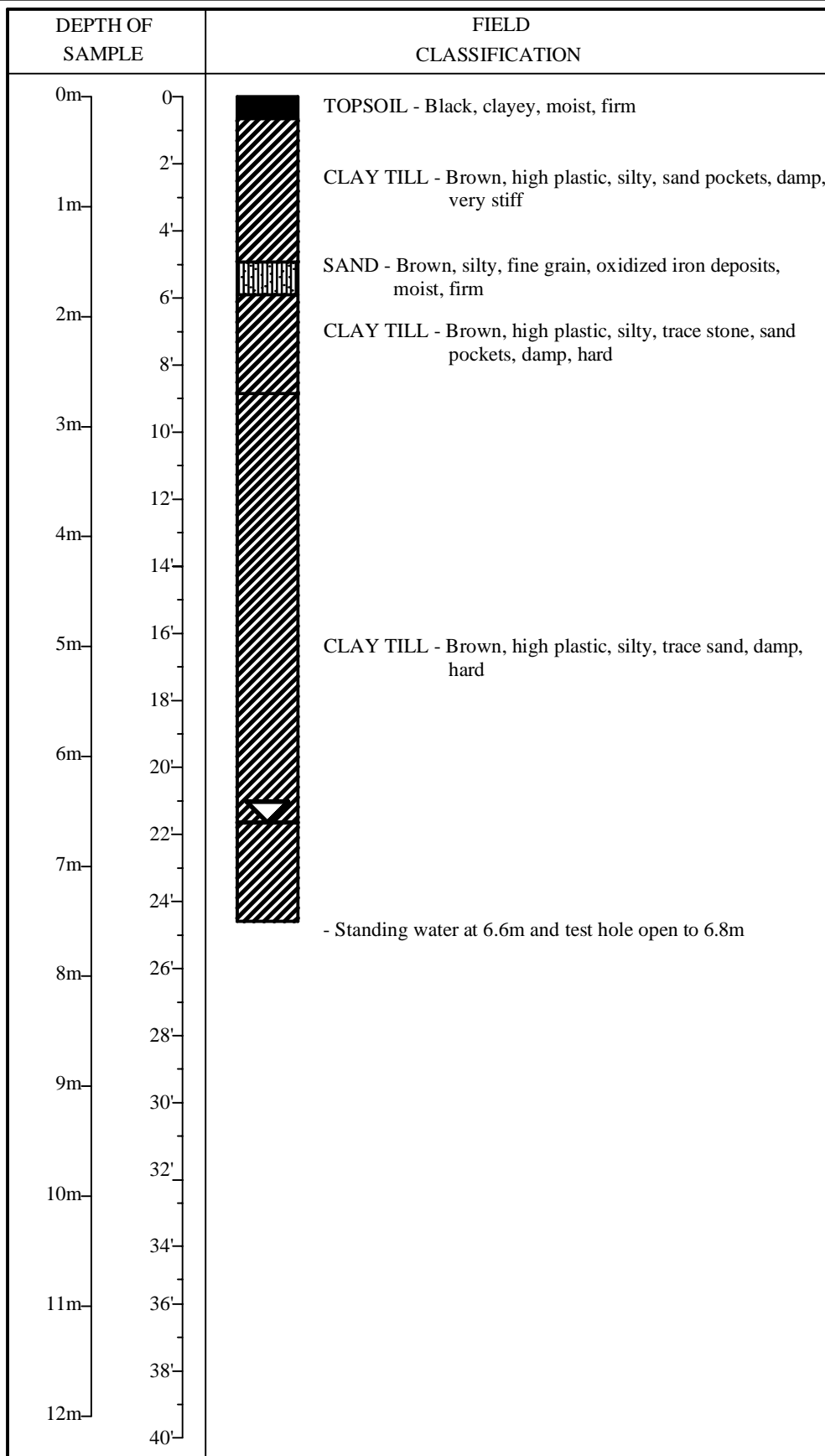

GW

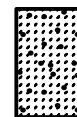

GP

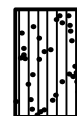

GM

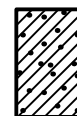

GC



SW

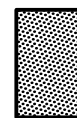

SP



SM



SC

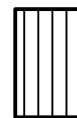

ML

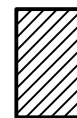

CL

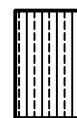

OL



CI



MH



CH



OH



PT



Topsoil



Static Water Level

The soil logs are based upon objective data available to us at the time of forming our opinions. The soil logs indicate site specific soil characteristics and must not be generalized over larger areas due to the limited number of test holes as compared to that of an unlimited number of test holes. Every effort is made to evaluate the information by methods generally recognized. The soil represent our opinions. J.R. Cousin Consultants Ltd. cannot be responsible for actual site conditions proved to be materially at variance from our analysis or from the data generalization over untested areas.

J. R. Cousin Consultants Ltd.

TEST HOLE LOG SHEET

LOCATION : SW 35-8-21 WPM

CODE : N-324.02

DATE : SEPTEMBER 9, 2015

COORDINATES: N 5505454, E 411711









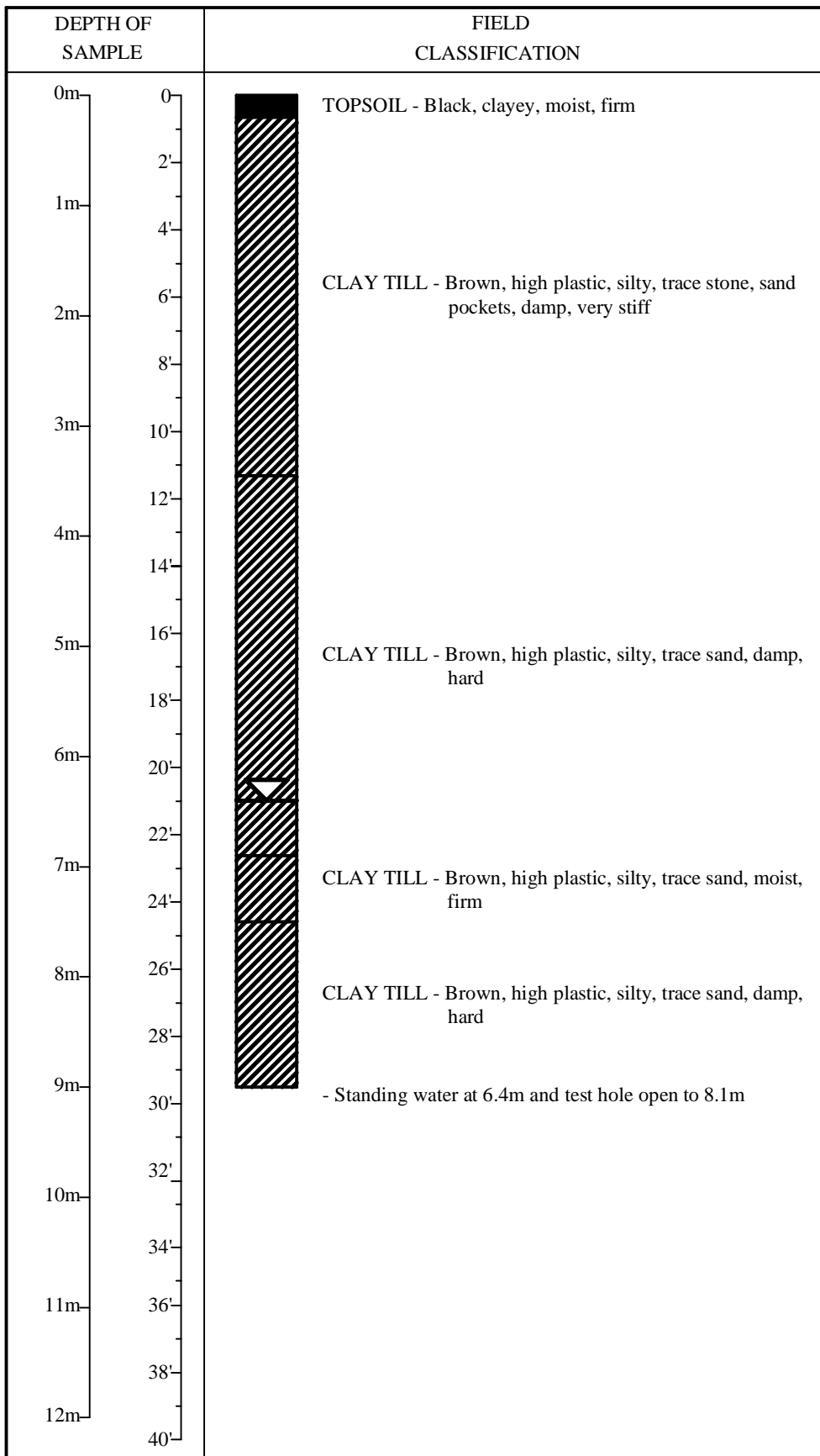

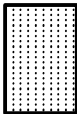
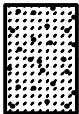
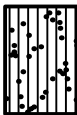
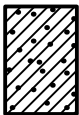

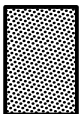

ELEVATION : 445.28m

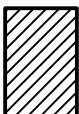
METHOD OF SAMPLING : Drill Rig

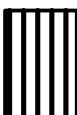
PROJECT : Municipal Wastewater Management, WDG Expansion EAP

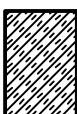
TEST HOLE # 2



 GW	 GP
 GM	 GC
 SW	 SP
 SM	 SC
 ML	 CL
 OL	 CI
 MH	 CH
 OH	 PT
 Topsoil	 Static Water Level

The soil logs are based upon objective data available to us at the time of forming our opinions. The soil logs indicate site specific soil characteristics and must not be generalized over larger areas due to the limited number of test holes as compared to that of an unlimited number of test holes. Every effort is made to evaluate the information by methods generally recognized. The soil represent our opinions. J.R. Cousin Consultants Ltd. cannot be responsible for actual site conditions proved to be materially at variance from our analysis or from the data generalization over untested areas.

J. R. Cousin Consultants Ltd.

TEST HOLE LOG SHEET

LOCATION : SW 35-8-21 WPM

CODE : N-324.02

DATE : SEPTEMBER 9, 2015

COORDINATES: N 5505470, E 410960

ELEVATION : 442.67m

METHOD OF SAMPLING : Drill Rig

PROJECT : Municipal Wastewater Management, WDG Expansion EAP

TEST HOLE # 3

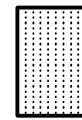
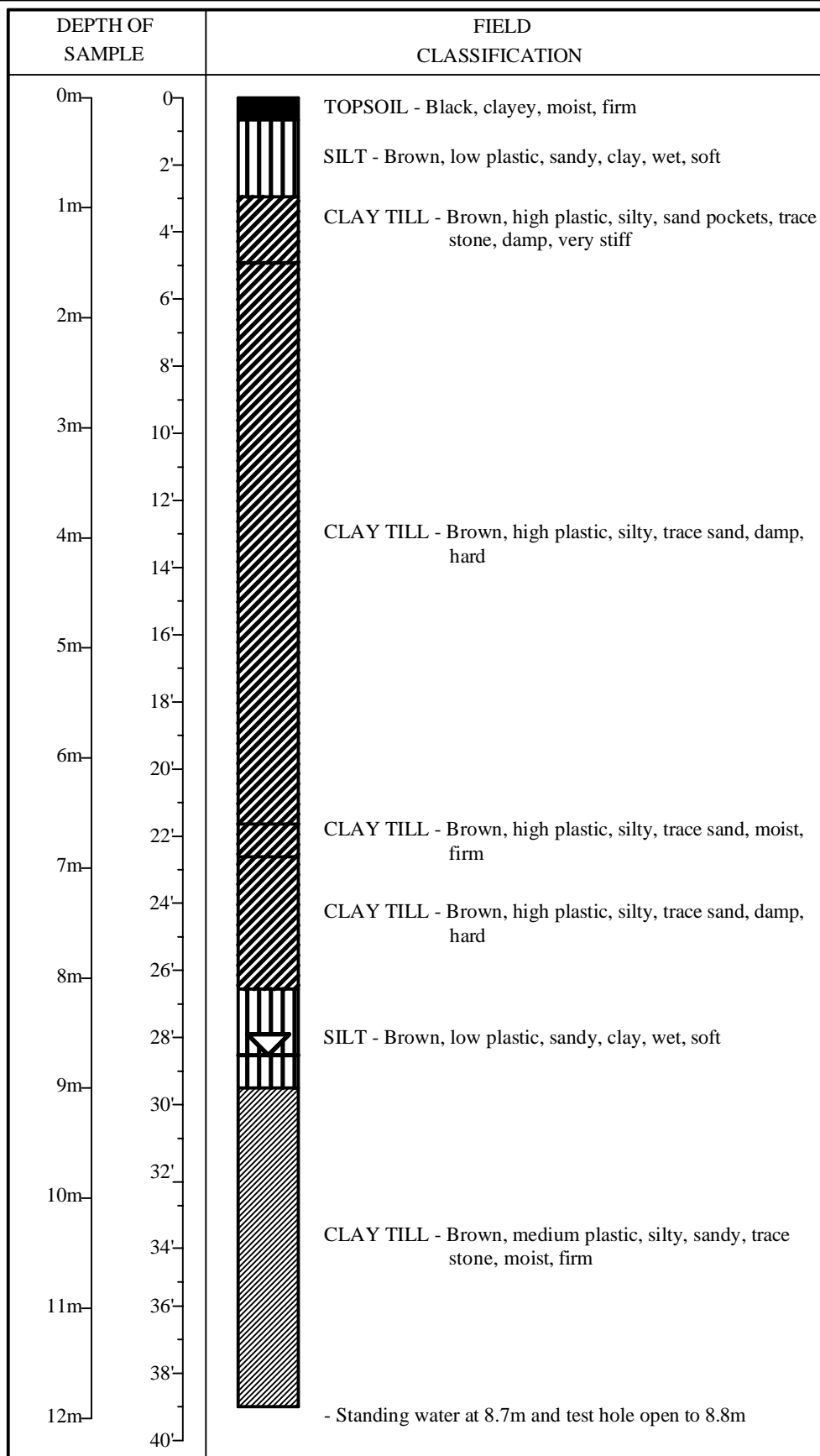

GW

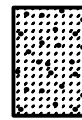

GP

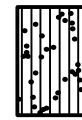

GM

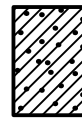

GC



SW

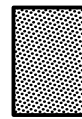

SP



SM



SC

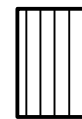

ML

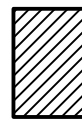

CL



OL



CI

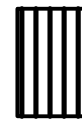

MH



CH



OH



PT



Topsoil



Static Water Level

The soil logs are based upon objective data available to us at the time of forming our opinions. The soil logs indicate site specific soil characteristics and must not be generalized over larger areas due to the limited number of test holes as compared to that of an unlimited number of test holes. Every effort is made to evaluate the information by methods generally recognized. The soil represent our opinions. J.R. Cousin Consultants Ltd. cannot be responsible for actual site conditions proved to be materially at variance from our analysis or from the data generalization over untested areas.

J. R. Cousin Consultants Ltd.

TEST HOLE LOG SHEET

LOCATION : SW 35-8-21 WPM

CODE : N-324.02

DATE : SEPTEMBER 9, 2015

COORDINATES: N 5505581, E 411279

ELEVATION : 444.25m

METHOD OF SAMPLING : Drill Rig

PROJECT : Municipal Wastewater Management, WDG Expansion EAP

TEST HOLE # 4

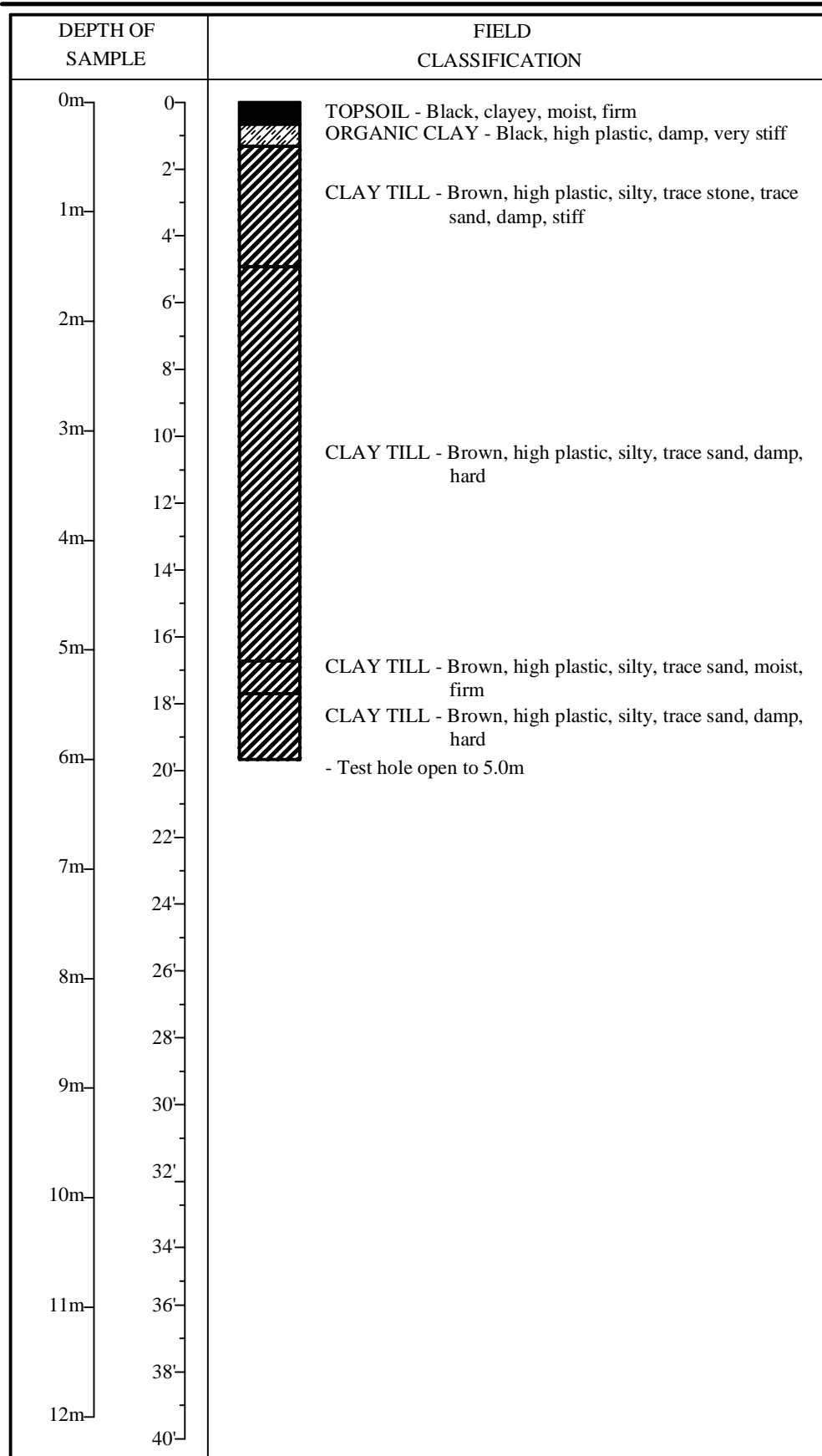

GW	GP
GM	GC
SW	SP
SM	SC
ML	CL
OL	CI
MH	CH
OH	PT
Topsoil	Static Water Level

The soil logs are based upon objective data available to us at the time of forming our opinions. The soil logs indicate site specific soil characteristics and must not be generalized over larger areas due to the limited number of test holes as compared to that of an unlimited number of test holes. Every effort is made to evaluate the information by methods generally recognized. The soil represent our opinions. J.R. Cousin Consultants Ltd. cannot be responsible for actual site conditions proved to be materially at variance from our analysis or from the data generalization over untested areas.

J. R. Cousin Consultants Ltd.

TEST HOLE LOG SHEET

LOCATION : SW 35-8-21 WPM

CODE : N-324.02

DATE : SEPTEMBER 9, 2015

COORDINATES: N 5505850, E 411082

ELEVATION : 442.65m

METHOD OF SAMPLING : Drill Rig

PROJECT : Municipal Wastewater Management, WDG Expansion EAP

TEST HOLE # 5

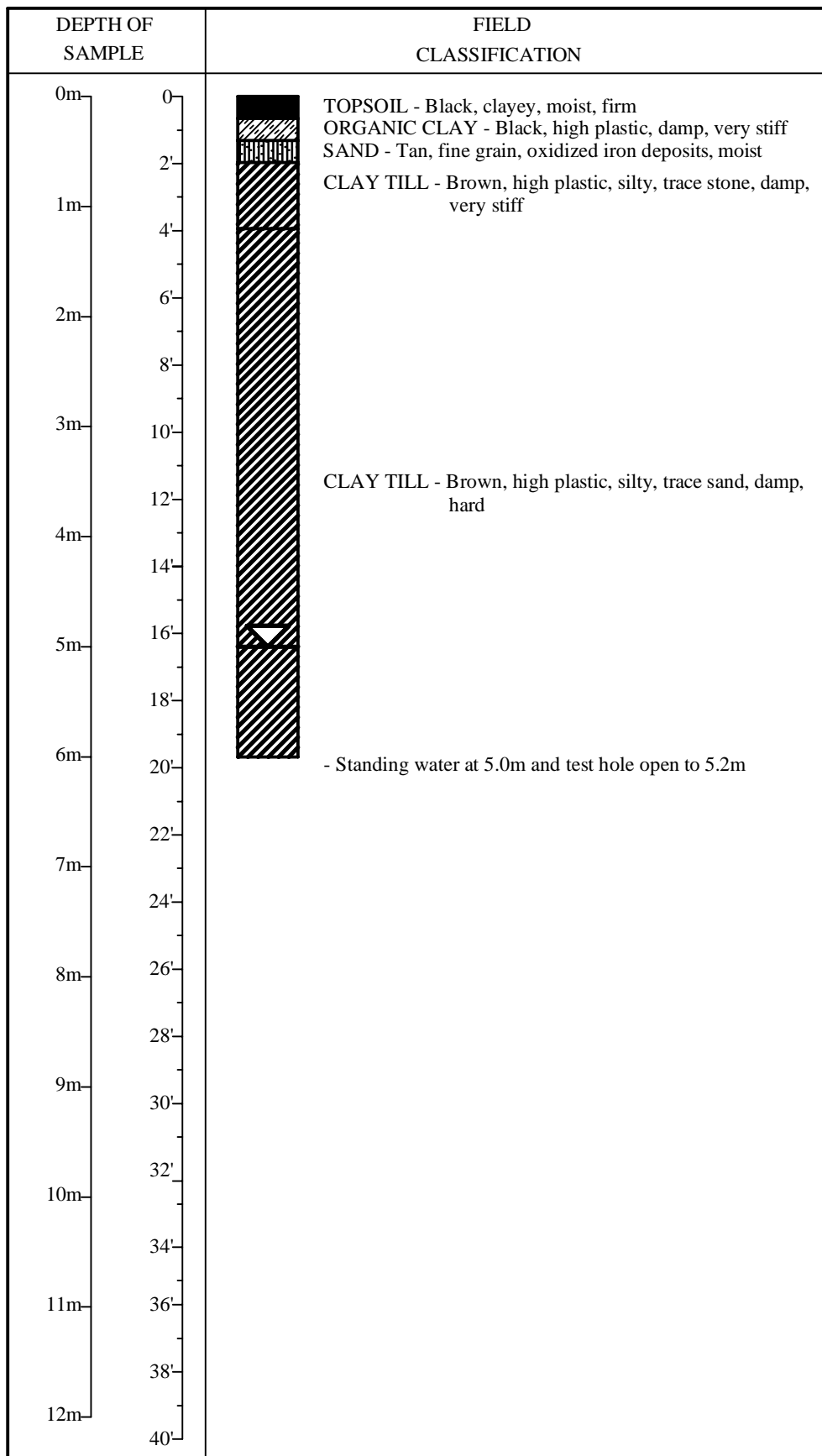

GW	GP
GM	GC
SW	SP
SM	SC
ML	CL
OL	CI
MH	CH
OH	PT
Topsoil	Static Water Level

The soil logs are based upon objective data available to us at the time of forming our opinions. The soil logs indicate site specific soil characteristics and must not be generalized over larger areas due to the limited number of test holes as compared to that of a unlimited number of test holes. Every effort is made to evaluate the information by methods generally recognized. The soil represent our opinions. J.R. Cousin Consultants Ltd. cannot be responsible for actual site conditions proved to be materially at variance from our analysis or from the data generalization over untested areas.

J. R. Cousin Consultants Ltd.

TEST HOLE LOG SHEET

LOCATION : SW 35-8-21 WPM

CODE : N-324.02

DATE : SEPTEMBER 9, 2015

COORDINATES: N 5506211, E 411302





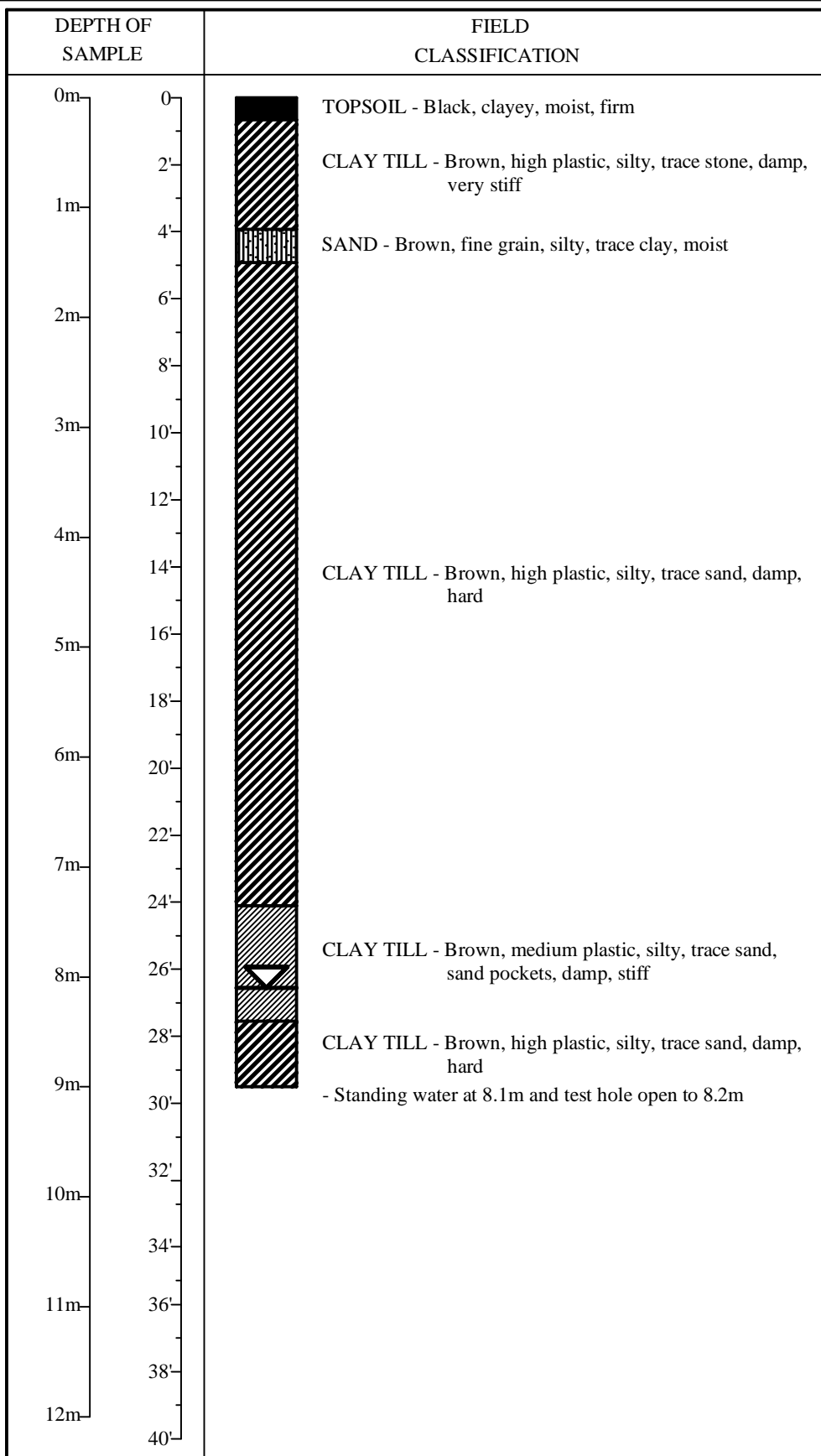

ELEVATION : 442.55m

METHOD OF SAMPLING : Drill Rig

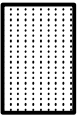
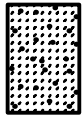
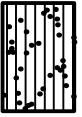
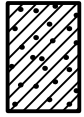
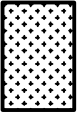
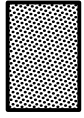
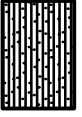
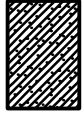
PROJECT : Municipal Wastewater Management, WDG Expansion EAP

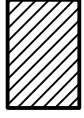
TEST HOLE # 6

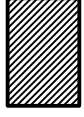
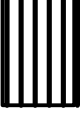
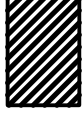
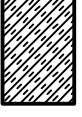
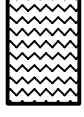

	
GW	GP
	
GM	GC
	
SW	SP
	
SM	SC
	
ML	CL
	
OL	CI
	
MH	CH
	
OH	PT
	
Topsoil	Static Water Level

The soil logs are based upon objective data available to us at the time of forming our opinions. The soil logs indicate site specific soil characteristics and must not be generalized over larger areas due to the limited number of test holes as compared to that of a unlimited number of test holes. Every effort is made to evaluate the information by methods generally recognized. The soil represent our opinions. J.R. Cousin Consultants Ltd. cannot be responsible for actual site conditions proved to be materially at variance from our analysis or from the data generalization over untested areas.

J. R. Cousin Consultants Ltd.

TEST HOLE LOG SHEET

LOCATION : SW 35-8-21 WPM

CODE : N-324.02

DATE : SEPTEMBER 9, 2015

COORDINATES: N 5506003, E 411502

ELEVATION : 443.52m

METHOD OF SAMPLING : Drill Rig

PROJECT : Municipal Wastewater Management, WDG Expansion EAP

TEST HOLE # 7

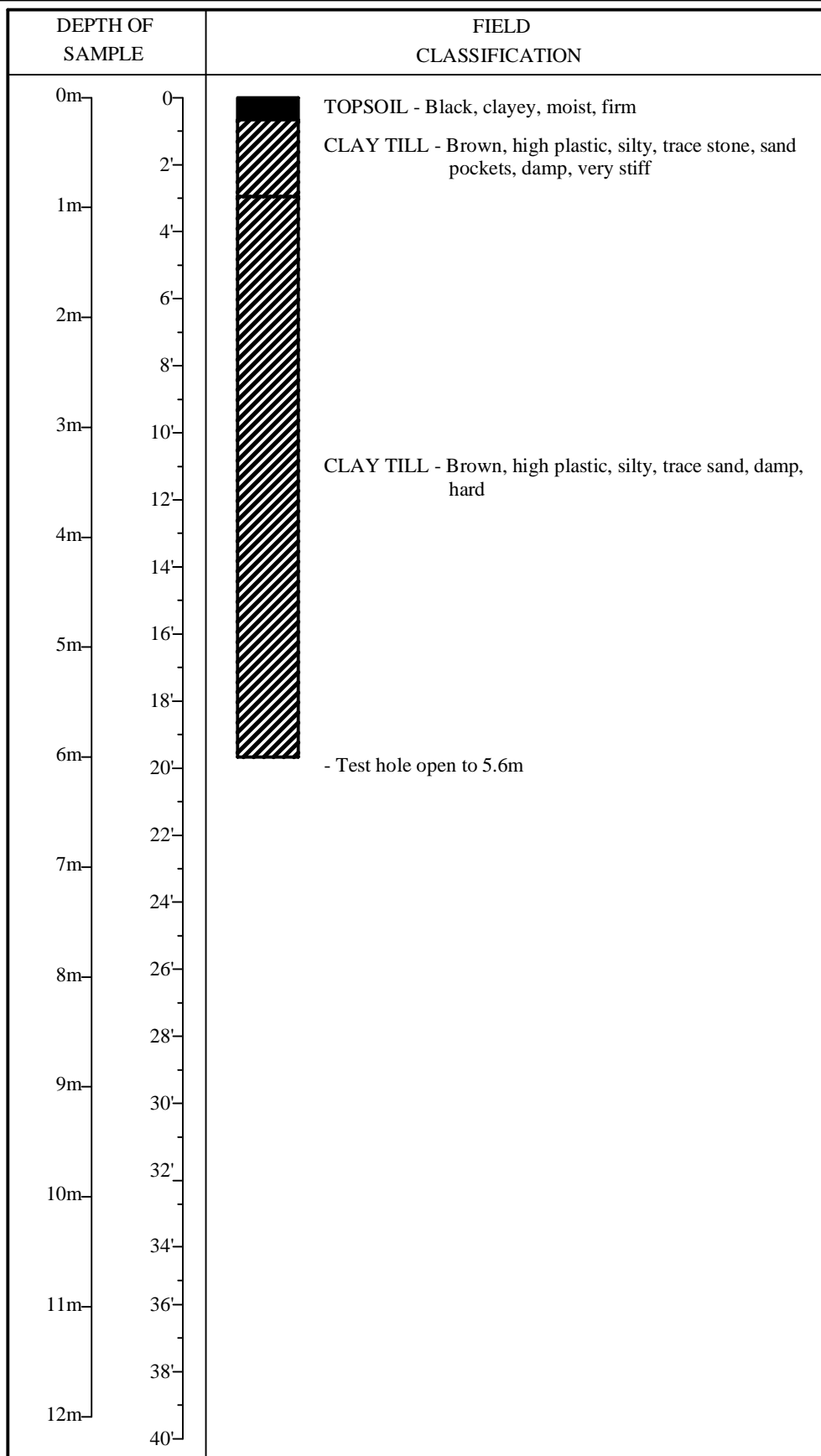

GW	GP
GM	GC
SW	SP
SM	SC
ML	CL
OL	CI
MH	CH
OH	PT
Topsoil	Static Water Level

The soil logs are based upon objective data available to us at the time of forming our opinions. The soil logs indicate site specific soil characteristics and must not be generalized over larger areas due to the limited number of test holes as compared to that of an unlimited number of test holes. Every effort is made to evaluate the information by methods generally recognized. The soil represent our opinions. J.R. Cousin Consultants Ltd. cannot be responsible for actual site conditions proved to be materially at variance from our analysis or from the data generalization over untested areas.

J. R. Cousin Consultants Ltd.

TEST HOLE LOG SHEET

LOCATION : SW 35-8-21 WPM

CODE : N-324.02

DATE : SEPTEMBER 9, 2015

COORDINATES: N 5506172, E 411716

ELEVATION : 443.79m

METHOD OF SAMPLING : Drill Rig

PROJECT : Municipal Wastewater Management, WDG Expansion EAP

TEST HOLE # 8

DEPTH OF SAMPLE		FIELD CLASSIFICATION	
0m	0'	TOPSOIL - Black, clayey, moist, firm	
	2'	CLAY TILL - Brown, high plastic, silty, trace stone, damp, stiff	
1m	4'		
	6'		
2m	8'		
	10'		
3m	12'		
	14'	CLAY TILL - Brown, high plastic, silty, trace sand, damp, hard	
4m	16'		
	18'		
5m	20'		
	22'		
6m	24'		
	26'	CLAY TILL - Brown, high plastic, silty, trace sand, sand pockets, damp, stiff	
7m	28'		
	30'	CLAY TILL - Brown, high plastic, silty, trace sand, damp, hard	
8m	32'		
	34'	CLAY TILL - Brown, high plastic, silty, trace sand, sand pockets, damp, stiff	
9m	36'		
	38'	CLAY TILL - Brown, high plastic, silty, trace sand, damp, hard	
10m	40'	- Test hole open to 6.0m	

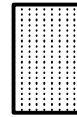

GW

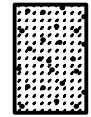

GP

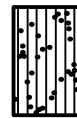

GM

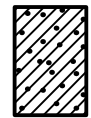

GC



SW

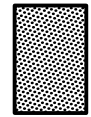

SP



SM



SC

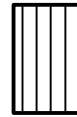

ML

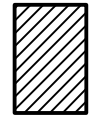

CL

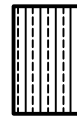

OL



CI



MH



CH



OH



PT



Topsoil



Static Water Level

The soil logs are based upon objective data available to us at the time of forming our opinions. The soil logs indicate site specific soil characteristics and must not be generalized over larger areas due to the limited number of test holes as compared to that of an unlimited number of test holes. Every effort is made to evaluate the information by methods generally recognized. The soil represent our opinions. J.R. Cousin Consultants Ltd. cannot be responsible for actual site conditions proved to be materially at variance from our analysis or from the data generalization over untested areas.

J. R. Cousin Consultants Ltd.

TEST HOLE LOG SHEET

LOCATION : SW 35-8-21 WPM

CODE : N-324.02

DATE : SEPTEMBER 9, 2015

COORDINATES: N 5505870, E 411591

ELEVATION : 444.06m

METHOD OF SAMPLING : Drill Rig

PROJECT : Municipal Wastewater Management, WDG Expansion EAP

TEST HOLE # 9

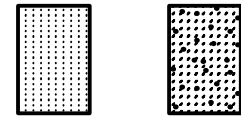
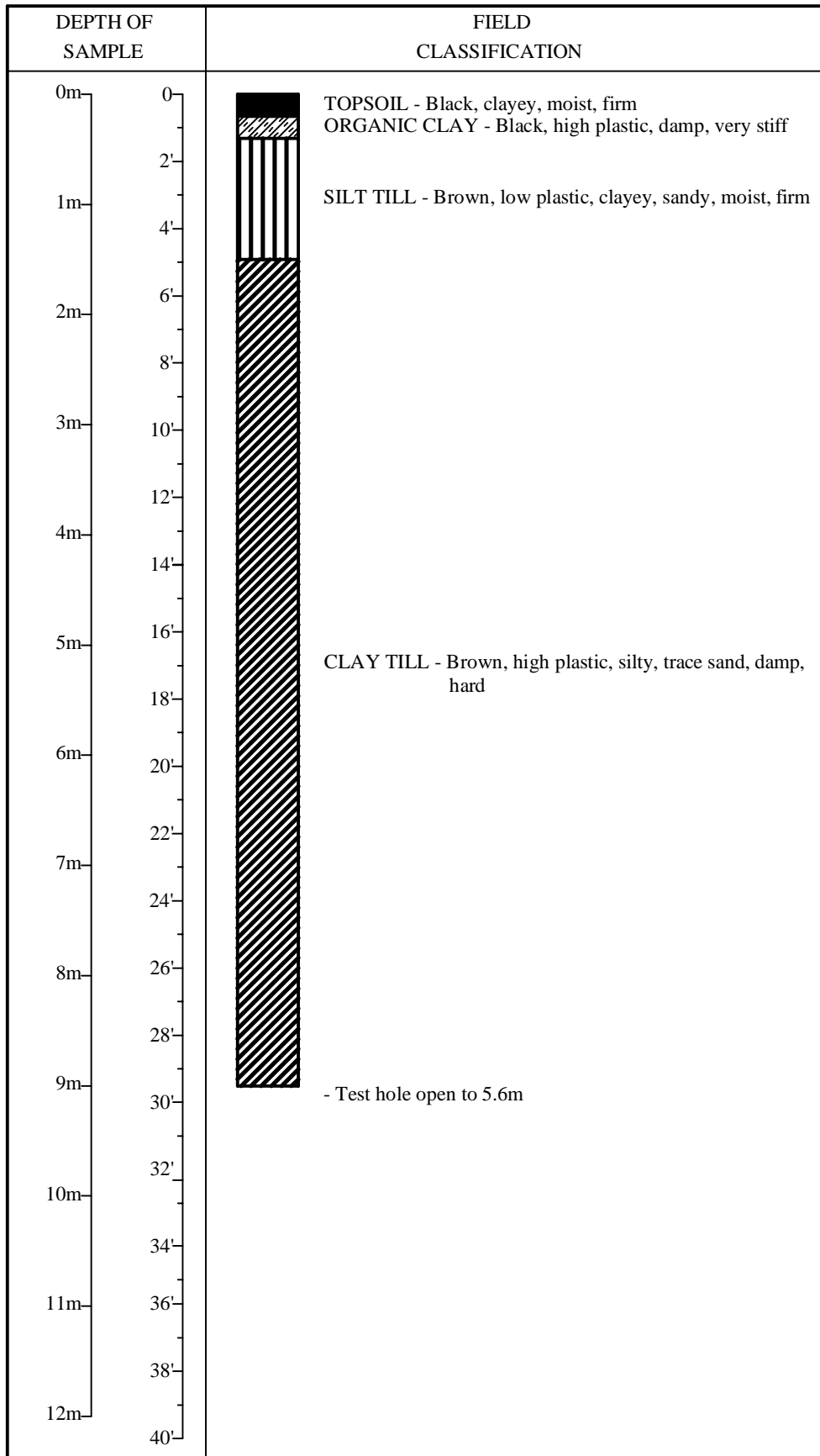

GW

GP

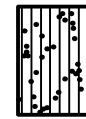

GM

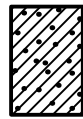

GC



SW

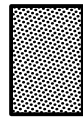

SP



SM



SC

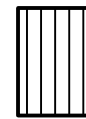

ML

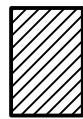

CL



OL

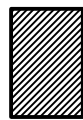

CI



MH



CH



OH

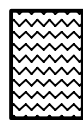

PT



Topsoil



Static Water Level

The soil logs are based upon objective data available to us at the time of forming our opinions. The soil logs indicate site specific soil characteristics and must not be generalized over larger areas due to the limited number of test holes as compared to that of an unlimited number of test holes. Every effort is made to evaluate the information by methods generally recognized. The soil represent our opinions. J.R. Cousin Consultants Ltd. cannot be responsible for actual site conditions proved to be materially at variance from our analysis or from the data generalization over untested areas.

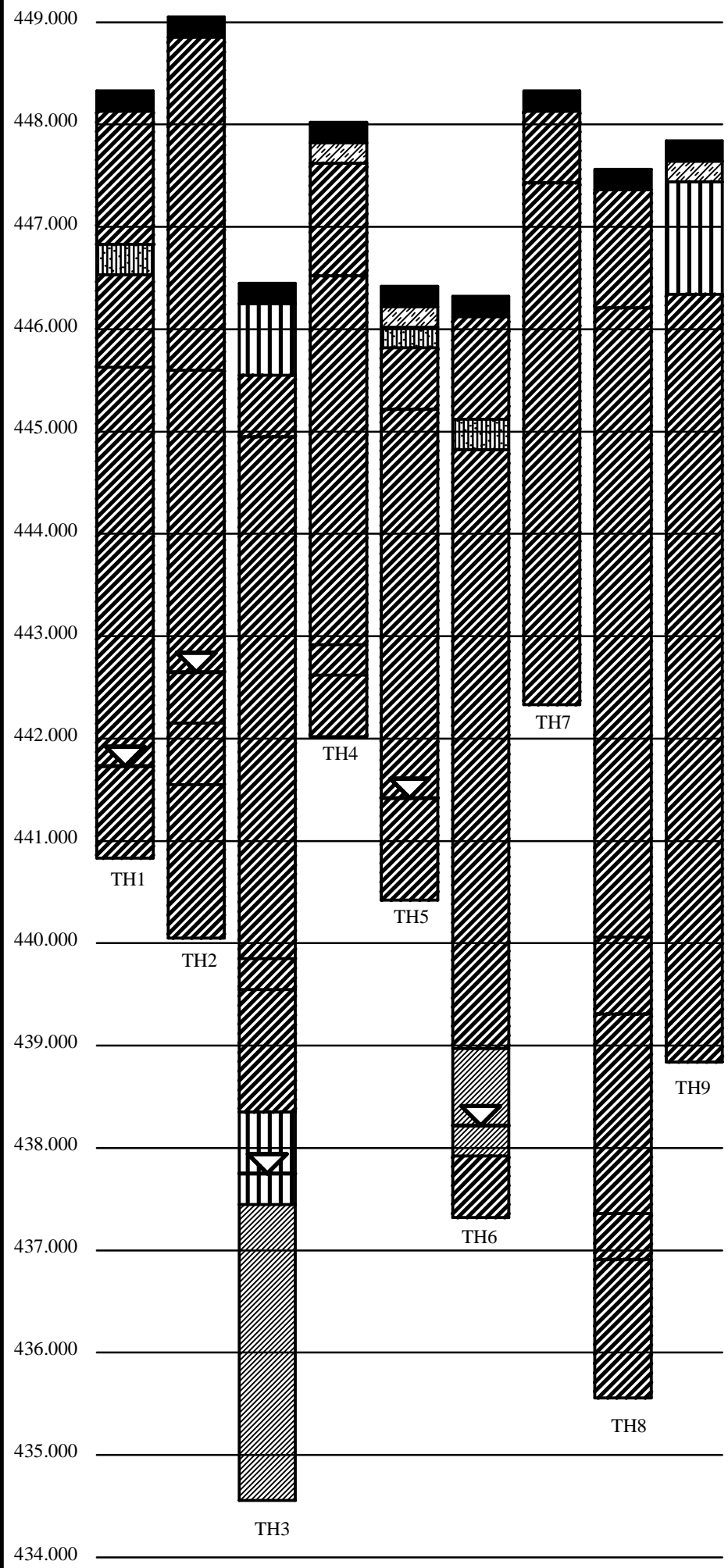

- LEGEND:**
- TOPSOIL
 - OH: ORGANIC CLAYS OF MEDIUM TO HIGH PLASTICITY, ORGANIC SILTS
 - CH: INORGANIC CLAYS OF HIGH PLASTICITY, FAT CLAYS
 - CI: INORGANIC CLAYS OF MEDIUM OR INTERMEDIATE PLASTICITY
 - SM: SILTY SANDS, SAND-SILT MIXTURES
 - CL: INORGANIC CLAYS OF LOW PLASTICITY, GRAVELLY CLAYS, SANDY OR SILTY CLAYS, LEAN CLAYS
 - MH: INORGANIC SILTS, FINE SANDY OR SILTY SOILS
 - STATIC WATER LEVEL

The soil logs are based upon objective data available to us at the time of forming our opinions. The soil logs indicate site specific soil characteristics and must not be generalized over larger areas due to the limited number of test holes as compared to that of an unlimited number of test holes. Every effort is made to evaluate the information by methods generally recognized. The soil represent our opinions. J.R. Cousin Consultants Ltd. cannot be responsible for actual site conditions proved to be materially at variance from our analysis or from the data generalization over untested areas.

AMEC Foster Wheeler Environment and Infrastructure – Soils Analysis Report, October 28, 2015

28 October 2015

Project No. WX11334-1300



J.R. Cousin Consultants Ltd.

91 Scurfield Boulevard
Winnipeg, Manitoba
R3Y 1G4

Attention: **Mr. Oswald Wohlgemut**

Re: **Soils Analysis
Municipal Waste Management**

1.0 INTRODUCTION

As authorized by Mr. Oswald Wohlgemut of J.R. Cousin Consultants Ltd. (JRCC), Amec Foster Wheeler Environment and Infrastructure, a division of Amec Foster Wheeler Americas Ltd. (Amec Foster Wheeler), has completed an evaluation of 4 soil samples (grab samples) that were submitted to our office by JRCC. Visual classification, Atterberg limits, particle size and moisture contents were requested. A large bulk (bucket) sample was also provided for standard Proctor testing and a remolded hydraulic conductivity test with one undisturbed Shelby tube sample also submitted for hydraulic conductivity testing. Comments relating to suitability of the soils as a lagoon cell liner was also requested.

2.0 LABORATORY TESTING

On receipt, the four grab samples were visually classified in accordance with the Modified Unified Soil Classification System and were tested for moisture content, particle size (hydrometer method) and Atterberg limits. The visual classification and laboratory testing results are summarized in Table 1 with the laboratory data summary also appended to this report.

Table 1: Lab Results

Sample Number	Depth (m)	Water Content (%)	Atterberg Limits			Particle Size Analysis			
			Liquid Limit (%)	Plastic Limit (%)	Plasticity Index	% Gravel	% Sand	% Silt	% Clay
TH01	1.8 – 2.8	25.4	52	15	37	0	6.6	52.1	41.3
	Classification: CH– Silt and Clay, trace sand, high plastic, moist								
TH01	2.8 – 7.5	28.2	55	16	39	0	12.8	43.7	43.5
	Classification: CH – Clay and Silt, some sand, high plastic, moist								
TH04	0.2 – 1.5	25.2	64	19	45	0	5.7	43.2	51.1
	Classification: CH – Clay and Silt, trace sand, high plastic, moist								
TH04	1.5 – 5.3	27.9	63	17	46	0	8.6	40.4	51.0
	Classification: CH – Clay and Silt, trace sand, high plastic, moist								

Note: Sample information provided by JRCC

As requested by JRCC, a standard Proctor and remoulded hydraulic conductivity test were undertaken on a bulk sample from TH4 (0.2 to 1.5m) with an undisturbed sample from TH4 (1.5 to 2.1m) also tested for hydraulic conductivity only. The results are as follows:

Standard Proctor (TH04 at 0.2m to 1.5m) - 1483 kg/m³ at 27.2%

TH04 – 0.2 to 1.5m

Standard Proctor – 1483 kg/m³ at 27.2% moisture

Hydraulic Conductivity – 5.93 x 10⁻⁹ cm/sec; (remoulded)

Completed at 97.8% SPMDD on the wet side of optimum.

TH04 – 1.5 to 2.1m

Hydraulic Conductivity – 1.2 x 10⁻⁸ cm/sec (undisturbed)

3.0 DISCUSSION

Amec Foster Wheeler was requested to comment on the suitability of the soils for use as a liner in a re-compacted condition, based on the visual assessment and the test results summarized 1 above. Feasibility for the utilization of the various materials as an impermeable liner for the proposed lagoon cell liner will largely depend on the quality and amount of the clay available. Typical engineering practice is to specify materials that comply with the following minimum parameters:

- Liquid Limit of 30% or greater ;
- Plastic Index of 10% or greater;
- 30% or more passing a number 200 mesh sieve; and
- 20% or more of clay particles (2-µm particle size)

In general, materials meeting the combination of characteristics noted above would provide a liner having a hydraulic conductivity not exceeding 1×10^{-7} cm/sec. Based on the laboratory test data, the samples submitted to our office from test holes TH01 and TH04 would meet the above criteria. The hydraulic conductivity test completed on both the remoulded and undisturbed samples further indicate that the high plastic soils noted in the above table will likely achieve the requirement of a maximum of 1×10^{-7} cm/sec.

4.0 CLOSURE

Amec Foster Wheeler trusts that the forgoing is sufficient for your present requirements. Should you require additional information, please contact the undersigned at this office.

Sincerely,
Amec Foster Wheeler Environment & Infrastructure
A Division of Amec Foster Wheeler Americas Limited

Trevor Gluck, P. Eng.
Senior Geotechnical Engineer

Reviewed By:
Harley Pankratz, P. Eng.

Attachments;
Lab Summary (1)
Proctor Test (1)
Hydraulic Conductivity Test (2)

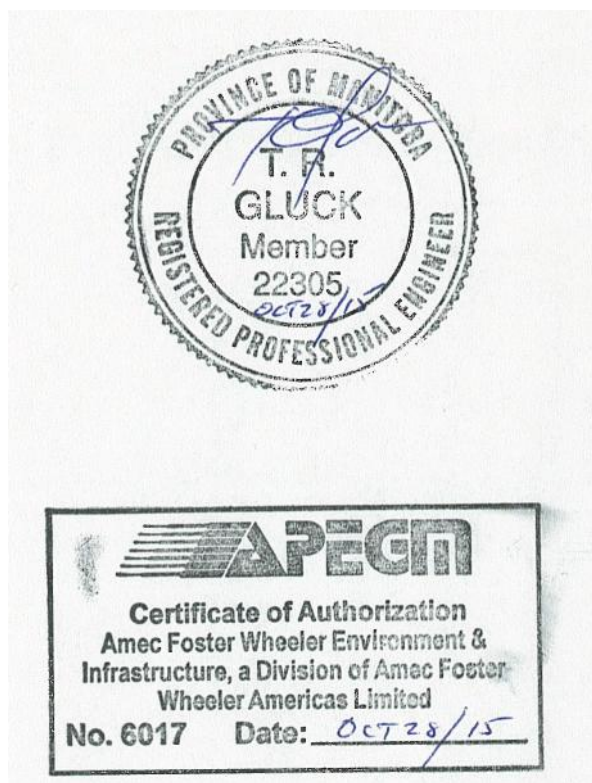

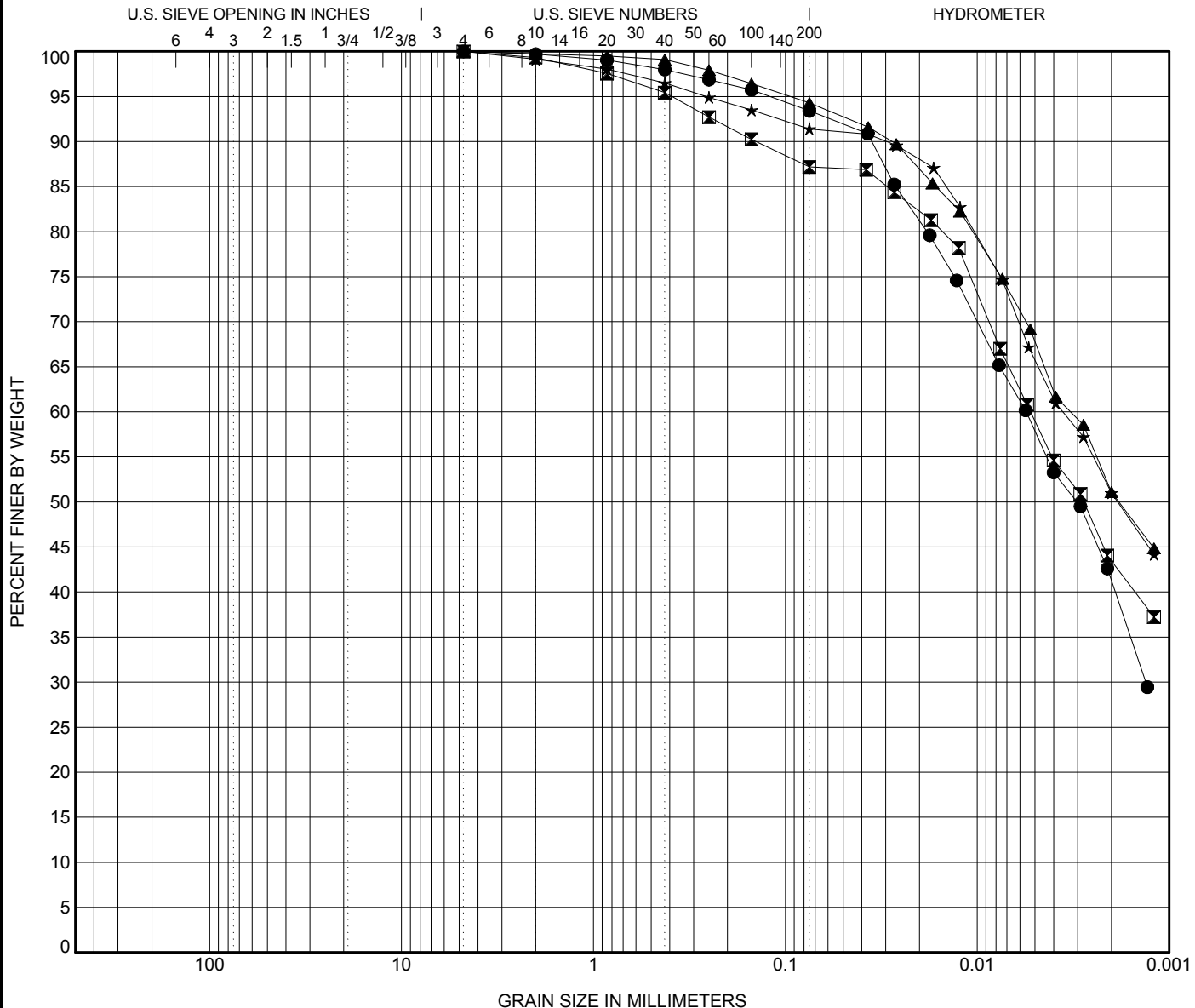

Moisture / Density Relationship



Report Date: September 29, 2015

Client
Name: JR Cousin Consultants
Address: 91A Scurfield Blvd Winnipeg, MB R3Y 1G4
Attention: David Kelly
PO Number:
Sample Date: 9/23/2015 by Client
Source: TH04 S01 @ 0.2m to 1.5m

Project
Name: (WX11334) Various Projects 2015
Address: Winnipeg, Manitoba
Phase: **Task:**
Manager: Trevor Gluck
Lab/Ref. #: WX11334.1300-01
Description: Clay

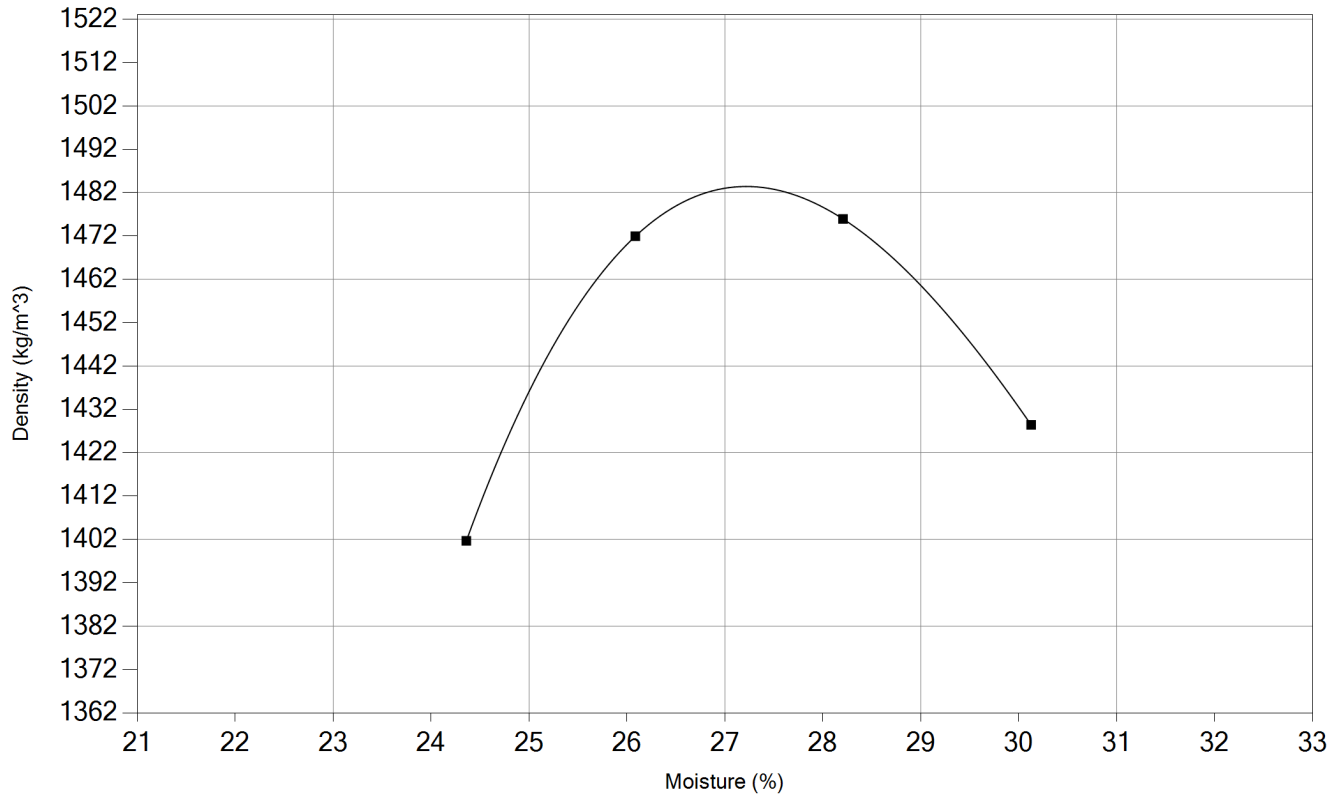

Moisture Density Relationship: (ASTM D698-07) Method: A

Preparation Method: Dry **Rammer Type:** Mechanical

Maximum Density (kg/m³): 1483

Optimum Moisture (%): 27.2

Remarks:

Distribution: AmecFosterWheeler-Admin, Vijay Modha

Reviewed By: Randell Johnson

Amec Foster Wheeler Environment & Infrastructure - 440 Dovercourt Drive - Winnipeg, MB - R3Y 1N4 Canada

Phone: (204) 488 2997 Fax: (204) 489 8261

CCIL CCIL Certified Aggregate Type C & Type D

ASTM D5084 - HYDRAULIC CONDUCTIVITY REPORT



TO: Oswald Wohlgemut, M.Sc
 JR Cousin Consultants Ltd
 91 Scurfield Boulevard
 Winnipeg, MB R3Y 1G4

PROJECT NO: WX11334 - 1300
CLIENT: JR Cousin Consultants Ltd
DATE SUBMITTED: 23-Sep-15

PROJECT: Municipal Waste Management

TEST HOLE: TH04
SAMPLE NO.: 1
SAMPLE DEPTH: 0.2-1.5m
PERMEANT: De-Aired Tap Water
HYDRAULIC GRADIENT: 28.68

CONSTANT HEAD METHOD ($K = cQL/thA$)

	Sample Height, L (cm)	Sample Dia. (cm)	Water Content (%)	Dry Density (kg/m ³)	Degree of Saturation (%)	Cell Pressure (kPa)	Back Pressure (kPa)	Differential Pressure, h (kPa)
Initial	7.35	7.24	29.7%	1451	93.3%			
Final	7.30	7.27	34.3%	1409	101.3%	241.4	196.5	20.7

Date & Time		Time, t (seconds)	Flow (Q)		Temp. Corr, c	Hyd. Cond. Corrected, K (cm/s)
Start	End		Influent (ml)	Effluent (ml)		
10/6/15 7:24 AM	10/7/15 7:36 AM	87120	0.60	0.55	1.225	6.86E-09
10/7/15 7:36 AM	10/8/15 7:20 AM	85440	0.65	0.60	0.968	6.00E-09
10/8/15 7:20 AM	10/9/15 7:26 AM	86760	0.65	0.60	0.980	5.99E-09
10/9/15 7:26 AM	10/13/15 7:33 AM	346020	2.30	2.20	0.980	5.40E-09
10/13/15 7:33 AM	10/14/15 7:19 AM	85560	0.65	0.65	0.980	6.31E-09

Soil Description: CLAY(remould) -and silt, trace sand, high plastic moist, firm, greyish brown

Standard Proctor Maximum Dry Density: 1483 kg/m³
 Optimum Moisture Content (OMC): 27.2 %
 Percent of SPMDD Achieved: 97.84 %

Average Temperature
Corrected Value (cm/s): 5.93E-09

Amec Foster Wheeler Environment & Infrastructure

Per: 
 Brad Wiebe, M.Sc., P.Eng.
 Associate Geotechnical Engineer

*Reporting of these results constitutes a testing service only.
 Engineering interpretation or evaluation of the test results is provided only on written request.*

ASTM D5084 - HYDRAULIC CONDUCTIVITY REPORT



TO: Oswald Wohlgemut, M.Sc
JR Cousin Consultants Ltd
91 Scurfield Boulevard
Winnipeg, MB R3Y 1G4

PROJECT NO: WX11334 - 1300
CLIENT: JR Cousin Consultants Ltd
DATE SUBMITTED: 23-Sep-15

PROJECT: Municipal Waste Management

TEST HOLE: TH04
SAMPLE NO.: 2
SAMPLE DEPTH: 1.5-2.1m

PERMEANT: De-Aired Tap Water
HYDRAULIC GRADIENT: 28.78

CONSTANT HEAD METHOD ($K = cQL/thA$)

	Sample Height, L (cm)	Sample Dia. (cm)	Water Content (%)	Dry Density (kg/m ³)	Degree of Saturation (%)	Cell Pressure (kPa)	Back Pressure (kPa)	Differential Pressure, h (kPa)
Initial	7.33	7.21	23.3%	1651	96.3%	241.4	196.5	20.7
Final	7.38	7.27	27.8%	1571	101.8%			

Date & Time		Time, t (seconds)	Flow (Q)		Temp. Corr, c	Hyd. Cond. Corrected, K (cm/s)
Start	End		Influent (ml)	Effluent (ml)		
10/6/15 7:22 AM	10/7/15 7:34 AM	87120	1.50	1.45	1.225	1.77E-08
10/7/15 7:34 AM	10/8/15 7:17 AM	85380	1.30	1.30	0.968	1.25E-08
10/8/15 7:17 AM	10/9/15 7:24 AM	86820	1.40	1.35	0.980	1.32E-08
10/9/15 7:24 AM	10/13/15 7:32 AM	346080	4.75	4.70	0.980	1.14E-08
10/13/15 7:32 AM	10/14/15 7:17 AM	85500	1.15	1.10	0.980	1.10E-08

Soil Description: CLAY -and silt, trace sand, high plastic, moist, stiff (PP=2.5), greyish brown, occasional sulphate inclusions

Average Temperature
Corrected Value (cm/s): 1.20E-08

Amec Foster Wheeler Environment & Infrastructure

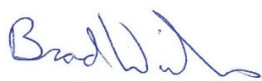
Per: 
Brad Wiebe, M.Sc., P.Eng.
Associate Geotechnical Engineer

*Reporting of these results constitutes a testing service only.
Engineering interpretation or evaluation of the test results is provided only on written request.*

Driller Well Log Reports

LOCATION: SW35-8-21W

Well_PID: 144140
Owner: MUNICIPAL WASTE MANAGEMENT
Driller: Ransom Drilling Ltd.
Well Name:
Well Use: TEST WELL
Water Use:
UTMX: 411349
UTMY: 5505830
Accuracy XY: 3 ACCURATE [50-350M] [WITHIN 1/4-SECTION]
UTMZ: 442
Accuracy Z: 4 FAIR - Shuttle at Centroid
Date Completed: 2007 Jul 26

WELL LOG

From (ft.)	To (ft.)	Log
0	2.0	BLACK SOIL
2.0	24.0	YELLOW CLAY TILL

No construction data for this well.

Top of Casing: 0.0

No pump test data for this well.

REMARKS

SOURIS, NO GROUNDWATER, IT IS IN THE SHALE.

LOCATION: SW35-8-21W

Well_PID: 75268
Owner: ROPER ENGINEERING
Driller: COSENS DRILLING LTD.
Well Name:
Well Use: TEST WELL
Water Use:
UTMX: 411389.269
UTMY: 5505844.51
Accuracy XY: UNKNOWN
UTMZ:
Accuracy Z:
Date Completed: 1992 Aug 28

WELL LOG

From (ft.)	To (ft.)	Log
---------------	-------------	-----

0	44.0	BROWN TILL
44.0	50.0	GREY TILL
50.0	50.5	FINE STICKY SAND
50.5	74.5	GREY TILL
74.5	75.0	FINE SAND
75.0	94.9	GREY TILL
94.9	96.9	FINE SILTY SAND
96.9	102.9	GREY TILL
102.9	116.9	FINE GREY SILTY SAND
116.9	119.9	SOFT CLAY
119.9	138.9	GREY TILL
138.9	139.9	GRAVEL
139.9	156.9	GREY TILL WITH THIN SAND LAYERS
156.9	169.9	HARD ODANAH SHALE

No construction data for this well.

Top of Casing: ft. below ground

No pump test data for this well.

REMARKS

ROPER ENVIRONMENTAL EXGINEERING INC

LOCATION: SW35-8-21W

Well_PID: 69623
 Owner: G NESTIBO
 Driller: Paddock Drilling Ltd.
 Well Name:
 Well Use: TEST WELL
 Water Use: Other
 UTMX: 411389.269
 UTM Y: 5505844.51
 Accuracy XY: UNKNOWN
 UTM Z:
 Accuracy Z:
 Date Completed: 1990 Jun 22

WELL LOG

From (ft.)	To (ft.)	Log
0	46.0	BROWN TILL, SOFT, ODD PEBBLE
46.0	51.0	GREY TILL, SOFT, ODD PEBBLE

No construction data for this well.

Top of Casing: ft. below ground

No pump test data for this well.

REMARKS

S.W. CORNER OF 1/4

LOCATION: SW35-8-21W

Well_PID: 69620
Owner: G NESTIBO
Driller: Paddock Drilling Ltd.
Well Name: TH-1
Well Use: TEST WELL
Water Use: Other
UTMX: 411389.269
UTMY: 5505844.51
Accuracy XY: UNKNOWN
UTMZ:
Accuracy Z:
Date Completed: 1990 Jun 22

WELL LOG

From (ft.)	To (ft.)	Log
0	1.0	OVERLAY
1.0	47.0	CLAY TILL, SOFT, ODD PEBBLE, BROWN
47.0	55.0	GREY TILL, SOFT, ODD PEBBLE
55.0	61.0	TILL, GREY, FIRMER, PEBBLY

No construction data for this well.

Top of Casing: ft. below ground

No pump test data for this well.

REMARKS

S.E. CORNER OF 1/4

LOCATION: SW35-8-21W

Well_PID: 69621
Owner: G NESTIBO
Driller: Paddock Drilling Ltd.
Well Name: TH-2
Well Use: TEST WELL
Water Use: Other

UTMX: 411389.269
UTMY: 5505844.51
Accuracy XY: UNKNOWN
UTMZ:
Accuracy Z:
Date Completed: 1990 Jun 22

WELL LOG

From (ft.)	To (ft.)	Log
0	1.0	OVERLAY
1.0	45.0	CLAY TILL, SOFT, ODD PEBBLE, BROWN
45.0	51.0	GREY TILL, SOFT, ODD PEBBLE

No construction data for this well.

Top of Casing: ft. below ground

No pump test data for this well.

REMARKS

N.E. CORNER OF 1/4

LOCATION: SW35-8-21W

Well_PID: 69622
Owner: G NESTIBO
Driller: Paddock Drilling Ltd.
Well Name: TH-3
Well Use: TEST WELL
Water Use:
UTMX: 411389.269
UTMY: 5505844.51
Accuracy XY: UNKNOWN
UTMZ:
Accuracy Z:
Date Completed: 1990 Jun 22

WELL LOG

From (ft.)	To (ft.)	Log
0	1.5	OVERLAY
1.5	45.0	CLAY TILL, SOFT, ODD PEBBLE, BROWN
45.0	53.0	CLAY TILL, SOFT, ODD PEBBLE, GREY
53.0	68.0	FIRMER GREY TILL, PEBBLY
68.0	68.2	SAND LENSE
68.2	69.0	BOULDER
69.0	71.0	FIRM GREY TILL

No construction data for this well.

Top of Casing: ft. below ground

No pump test data for this well.

REMARKS

N.W. CORNER OF 1/4

Appendix D

Title Page

Plan 1: Site Location Plan with Required Setbacks

Plan 2: Waste Disposal Ground Site with Test hole Location Plan

Plan 3: Proposed Waste Disposal Ground Expansion Layout and Drainage Plan

Plan 4: Dike, Liner and Leachate Pipe Details

Plan 5: Road, Ditch, Fence, Sign and Silt Fence Details

Plan 6: Site Operations Plan

MUNICIPAL WASTE MANAGEMENT

WASTE DISPOSAL GROUND EXPANSION

ENVIRONMENT ACT PROPOSAL

PRELIMINARY
NOT FOR CONSTRUCTION

PLAN INDEX

PLAN 1.	SITE LOCATION PLAN WITH REQUIRED SETBACKS
PLAN 2.	WASTE DISPOSAL GROUND SITE WITH TESTHOLE LOCATION PLAN
PLAN 3.	PROPOSED WASTE DISPOSAL GROUND EXPANSION LAYOUT AND DRAINAGE PLAN
PLAN 4.	DIKE, LINER AND LEACHATE PIPE DETAILS
PLAN 5.	ROAD, DITCH, FENCE, SIGN AND SILT FENCE DETAILS
PLAN 6.	SITE OPERATIONS PLAN

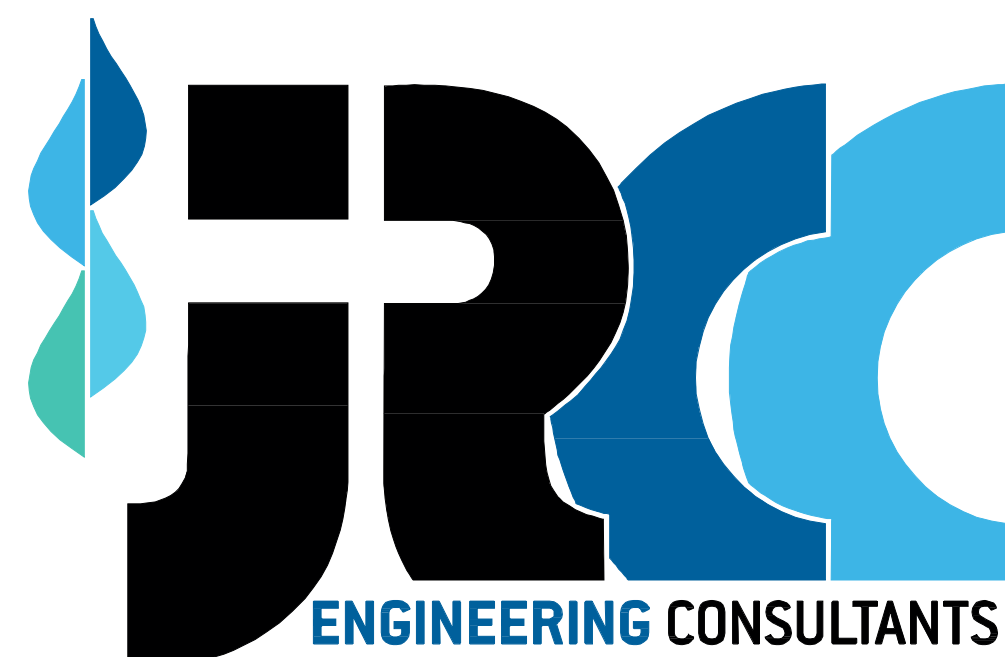

JR Cousin Consultants Ltd.

91A Scurfield Blvd. Winnipeg MB R3Y 1G4

p. (204) 489-0474

f. (204) 489-0487

www.jrcc.ca

ENGINEERING EXCELLENCE SINCE 1981

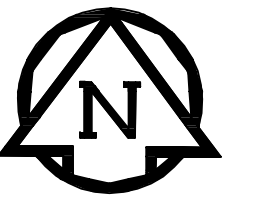

PRELIMINARY
NOT FOR CONSTRUCTION

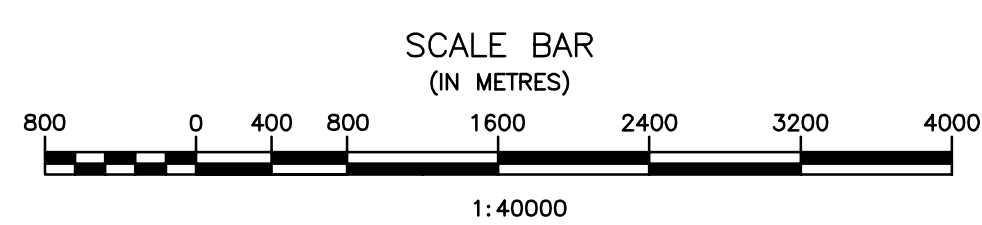

No.	REVISIONS	DATE	INITIALS

B.M. EL.

LOCATIONS OF UNDERGROUND STRUCTURES/UTILITIES AS SHOWN ARE BASED ON AVAILABLE INFORMATION BUT NO GUARANTEE IS GIVEN OR IMPLIED THAT ALL EXISTING UNDERGROUND STRUCTURES/UTILITIES ARE SHOWN OR THAT THE GIVEN LOCATIONS ARE EXACT. CONFIRMATION OF EXISTENCE AND EXACT LOCATION OF ALL UNDERGROUND STRUCTURES/UTILITIES MUST BE OBTAINED FROM THE APPROPRIATE AUTHORITY/OWNER, BY THE CONTRACTOR, BEFORE PROCEEDING WITH CONSTRUCTION.

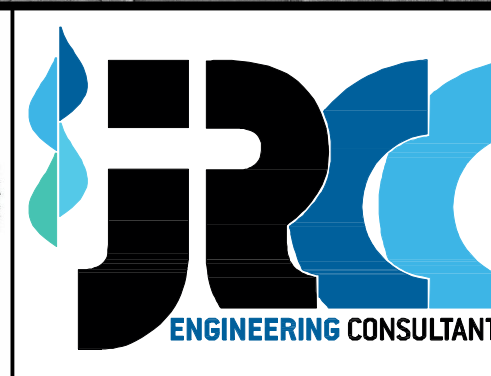
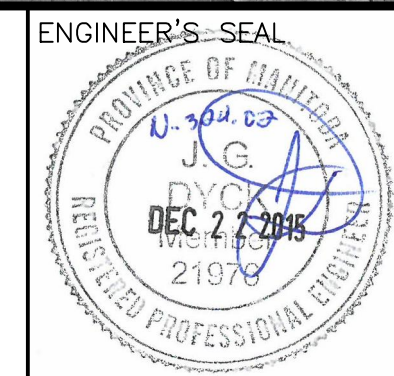

JR Cousin Consultants Ltd.
91A Scurfield Blvd. Winnipeg MB R3Y 1G4
p. (204) 489-0474
f. (204) 489-0487
www.jrcc.ca

CODE:	N-324.02			
DESIGNED BY:	OW			
DRAWN BY:	RH			
REVIEWED BY:	JD			
PROJECT:	MUNICIPAL WASTE MANAGEMENT WASTE DISPOSAL GROUND EXPANSION			
TITLE:	SITE LOCATION PLAN WITH REQUIRED SETBACKS			
SCALE:	DATE:	PLAN:	SHEET:	
1:40000	15/11/19	1	1 of 6	

Dec 27, 2015 - 10:28am P:\300\324 - Numbis - Corp\324.02 - WQ Development - Act 1\Proposed\CA - Develop\DWG\DWG_Plan_1.dwg



PRELIMINARY
NOT FOR CONSTRUCTION

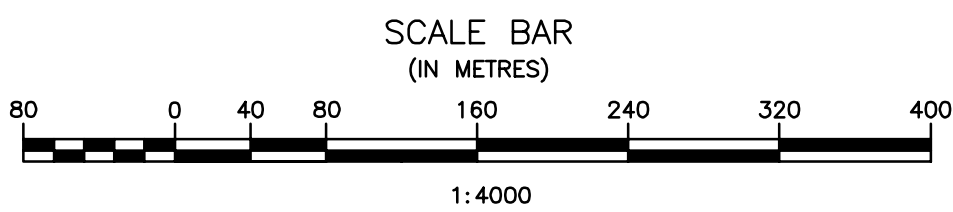

No.	REVISIONS	DATE	INITIALS

B.M. EL.

LOCATIONS OF UNDERGROUND STRUCTURES/UTILITIES AS SHOWN ARE BASED ON AVAILABLE INFORMATION BUT NO GUARANTEE IS GIVEN OR IMPLIED THAT ALL EXISTING UNDERGROUND STRUCTURES/UTILITIES ARE SHOWN OR THAT THE GIVEN LOCATIONS ARE EXACT. CONFIRMATION OF EXISTENCE AND EXACT LOCATION OF ALL UNDERGROUND STRUCTURES/UTILITIES MUST BE OBTAINED FROM THE APPROPRIATE AUTHORITY/OWNER, BY THE CONTRACTOR, BEFORE PROCEEDING WITH CONSTRUCTION.

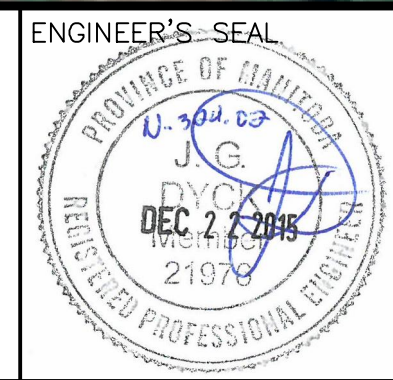

JR Cousin Consultants Ltd.
 91A Scurfield Blvd. Winnipeg MB R3Y 1G4
 p. (204) 489-0474
 f. (204) 489-0487
 www.jrcc.ca

ENGINEERING CONSULTANTS
 ENGINEERING EXCELLENCE SINCE 1981

CODE: N-324.02	PROJECT: MUNICIPAL WASTE MANAGEMENT WASTE DISPOSAL GROUND EXPANSION
DESIGNED BY: OW	TITLE: WASTE DISPOSAL GROUND SITE WITH TESTHOLE LOCATION PLAN
DRAWN BY: RH	SCALE: 1:4000
REVIEWED BY: JD	DATE: 15/11/19
	PLAN: 2
	SHEET: 2 of 6

Dec 22, 2019 - 10:45am P:\3000\324 - Manitoba - Copy\3000\324 - 1000 - Environment - Act - Proposal\04 - Drawings\DWG\DWG_Plan_Site.dwg



PRELIMINARY
NOT FOR CONSTRUCTION

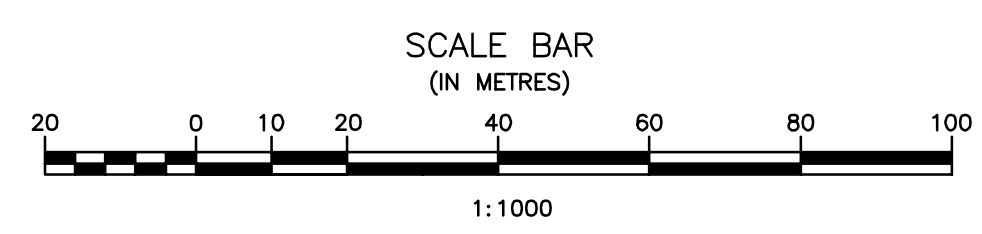

No.	REVISIONS	DATE	INITIALS

B.M. EL.

LOCATIONS OF UNDERGROUND STRUCTURES/UTILITIES AS SHOWN ARE BASED ON AVAILABLE INFORMATION BUT NO GUARANTEE IS GIVEN OR IMPLIED THAT ALL EXISTING UNDERGROUND STRUCTURES/UTILITIES ARE SHOWN OR THAT THE GIVEN LOCATIONS ARE EXACT. CONFIRMATION OF EXISTENCE AND EXACT LOCATION OF ALL UNDERGROUND STRUCTURES/UTILITIES MUST BE OBTAINED FROM THE APPROPRIATE AUTHORITY/OWNER, BY THE CONTRACTOR, BEFORE PROCEEDING WITH CONSTRUCTION.

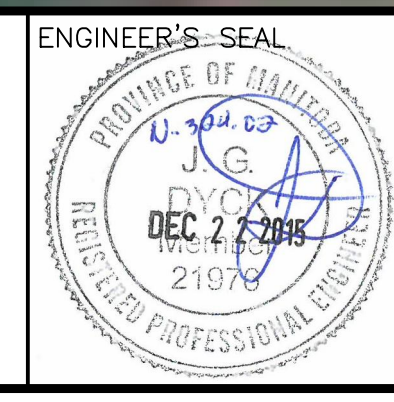







JR Cousin Consultants Ltd.
91A Scurfield Blvd. Winnipeg MB R3Y 1G4
p. (204) 489-0474
f. (204) 489-0487
www.jrcc.ca

ENGINEERING CONSULTANTS
ENGINEERING EXCELLENCE SINCE 1981

CODE: N-324.02	PROJECT: MUNICIPAL WASTE MANAGEMENT WASTE DISPOSAL GROUND EXPANSION
DESIGNED BY: OW	TITLE: PROPOSED WASTE DISPOSAL GROUND EXPANSION LAYOUT AND DRAINAGE PLAN
DRAWN BY: RH	SCALE: 1:1000
REVIEWED BY: JD	DATE: 15/11/19
	PLAN: 3
	SHEET: 3 of 6

Dec 27, 2019 - 12:28pm P:\300\324 - Numbis - Corp\324\02 - 1002 Development Act - Proposed\04 - Drainage\DWG\DWG_Plan_3.dwg

LEGEND:

-  EXCAVATED AND COMPACTED CLAY TYPE SOIL
-  SCARIFIED 150mm AND COMPACTED CLAY TYPE SOIL
-  EXCAVATED AND COMPACTED SOIL MATERIAL
-  EXCAVATED AND COMPACTED MIXTURE OF ORGANIC AND INORGANIC SOILS
-  TOPSOIL
-  INSITU
-  ASPHALT MILLINGS

LEVEL 1 - PRE-CONSTRUCTION EXISTING PRAIRIE ELEVATION
 LEVEL 2 - ELEVATION FOLLOWING STRIPPED ORGANICS/VEGETATION
 LEVEL 3 - FINISHED CELL BOTTOM ELEVATION
 LEVEL 2 AND 3 - TO BE COMPACTED WITH SHEEPSFOOT PACKER
 LEVEL 4 - BOTTOM OF LINER

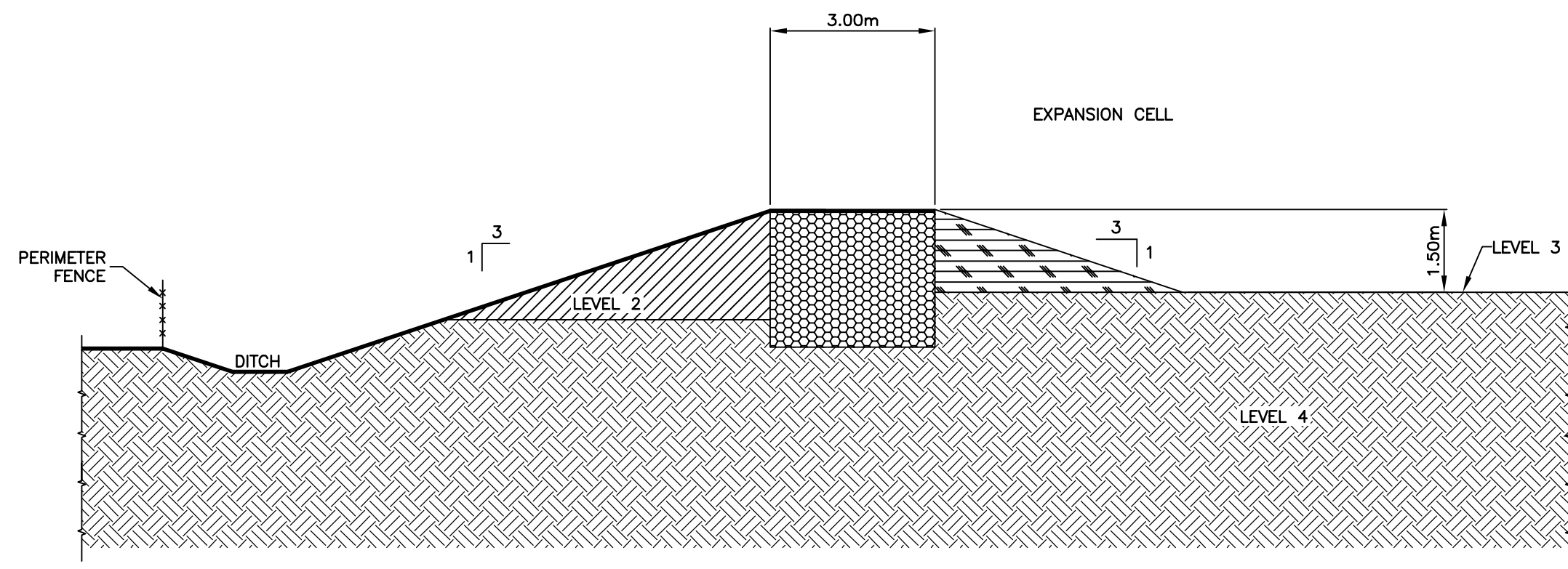

1 EXPANSION CELL WEST PERIMETER DIKE
 SCALE = 1:100

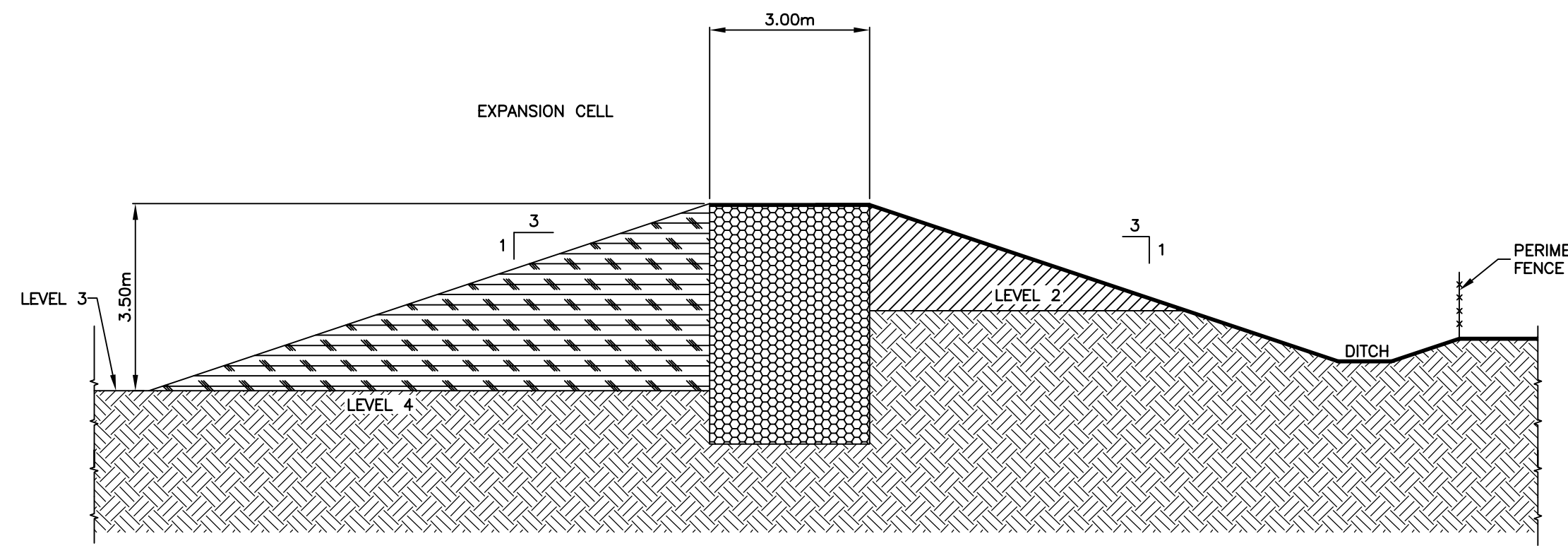

2 EXPANSION CELL EAST PERIMETER DIKE
 SCALE = 1:100

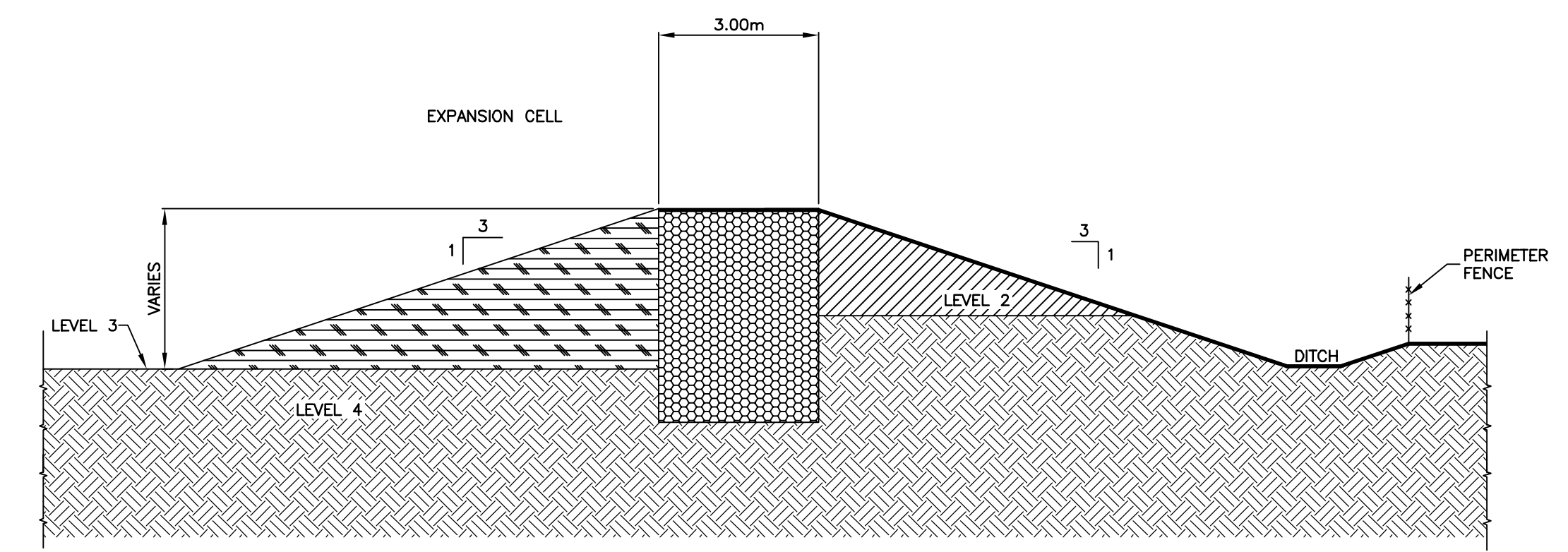

3 EXPANSION CELL NORTH AND SOUTH PERIMETER DIKE
 SCALE = 1:100

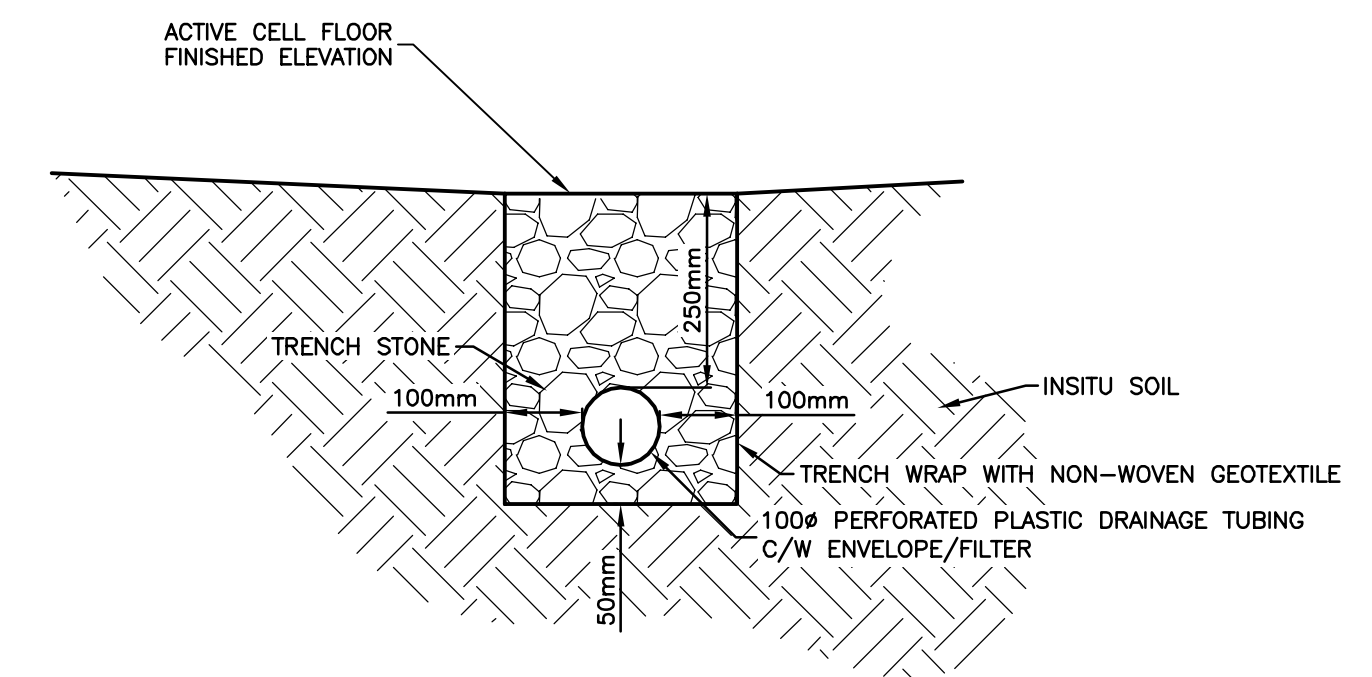

4 LEACHATE COLLECTION PIPING DETAIL
 SCALE: 1:10

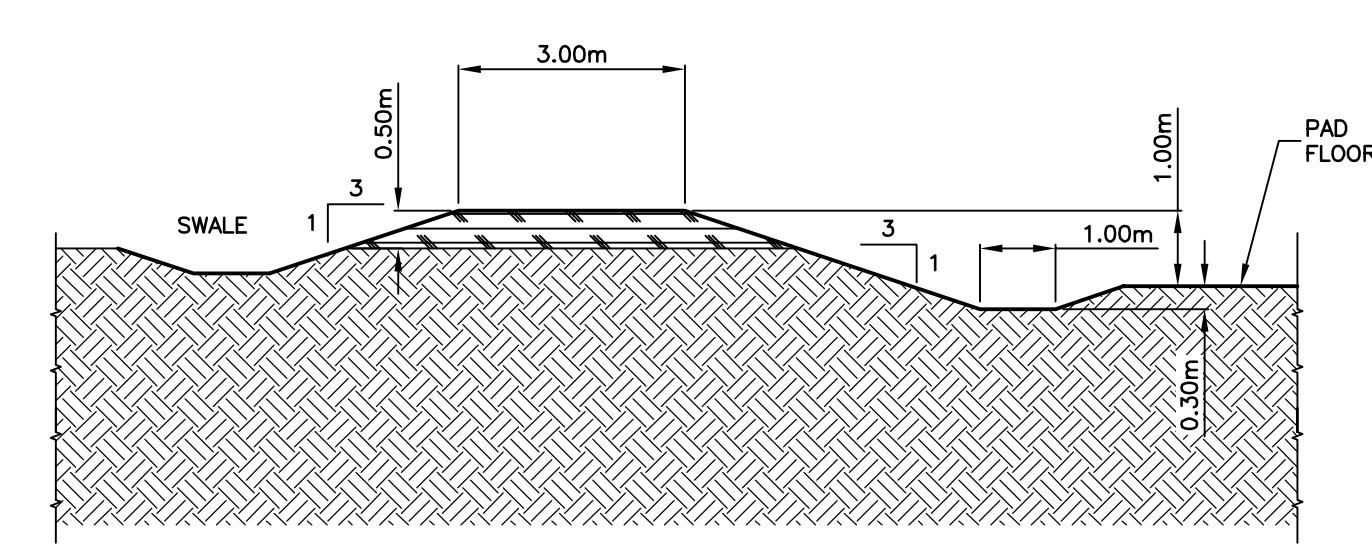

5 CONTAMINATED SOILS PAD WEST DIKE
 SCALE = 1:100

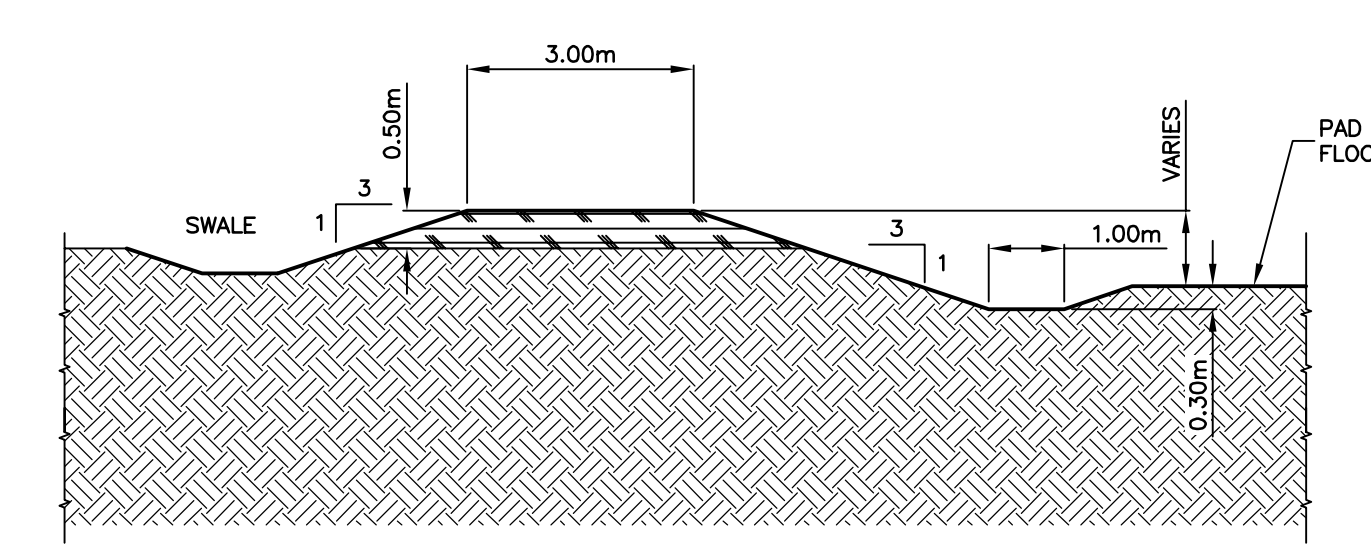

6 CONTAMINATED SOILS PAD NORTH AND SOUTH DIKE
 SCALE = 1:100

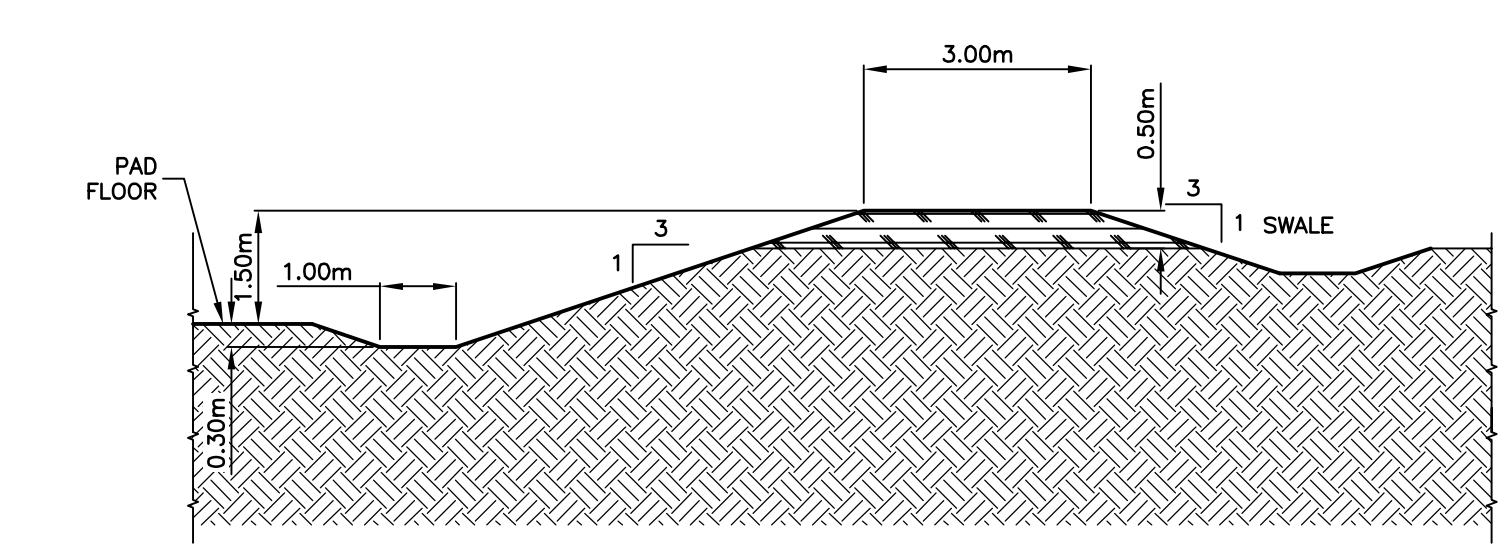

7 CONTAMINATED SOILS PAD EAST DIKE
 SCALE = 1:100

PRELIMINARY
 NOT FOR CONSTRUCTION

No.	REVISIONS	DATE	INITIALS	B.M. EL.

LOCATIONS OF UNDERGROUND STRUCTURES/UTILITIES AS SHOWN ARE BASED ON AVAILABLE INFORMATION BUT NO GUARANTEE IS GIVEN OR IMPLIED THAT ALL EXISTING UNDERGROUND STRUCTURES/UTILITIES ARE SHOWN OR THAT THE GIVEN LOCATIONS ARE EXACT. CONFIRMATION OF EXISTENCE AND EXACT LOCATION OF ALL UNDERGROUND STRUCTURES/UTILITIES MUST BE OBTAINED FROM THE APPROPRIATE AUTHORITY/OWNER, BY THE CONTRACTOR, BEFORE PROCEEDING WITH CONSTRUCTION.

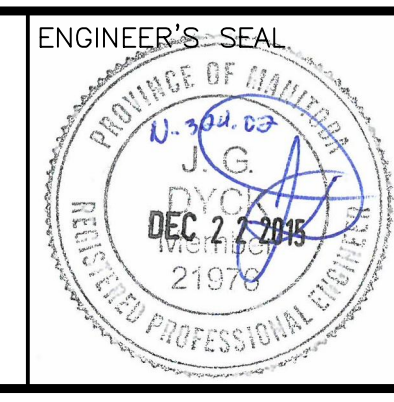

JR Cousin Consultants Ltd.
 91A Scurfield Blvd. Winnipeg MB R3Y 1G4
 p. (204) 489-0474
 f. (204) 489-0487
 www.jrcc.ca
 ENGINEERING EXCELLENCE SINCE 1981

CODE: N-324.02	PROJECT: MUNICIPAL WASTE MANAGEMENT WASTE DISPOSAL GROUND EXPANSION
DESIGNED BY: OW	TITLE: DIKE, LINER AND LEACHATE PIPE DETAILS
DRAWN BY: RH	SCALE: AS NOTED
REVIEWED BY: JD	DATE: 15/11/19
	PLAN: 4
	SHEET: 4 of 6

Dec 22, 2013 - 10:50pm P:\300\324 - Manitoba - Corp\324.02 - WQ2 Development - Act 1\Proposed\CA - Drawings\DWG\DWG\DWG_Plan - 4.dwg

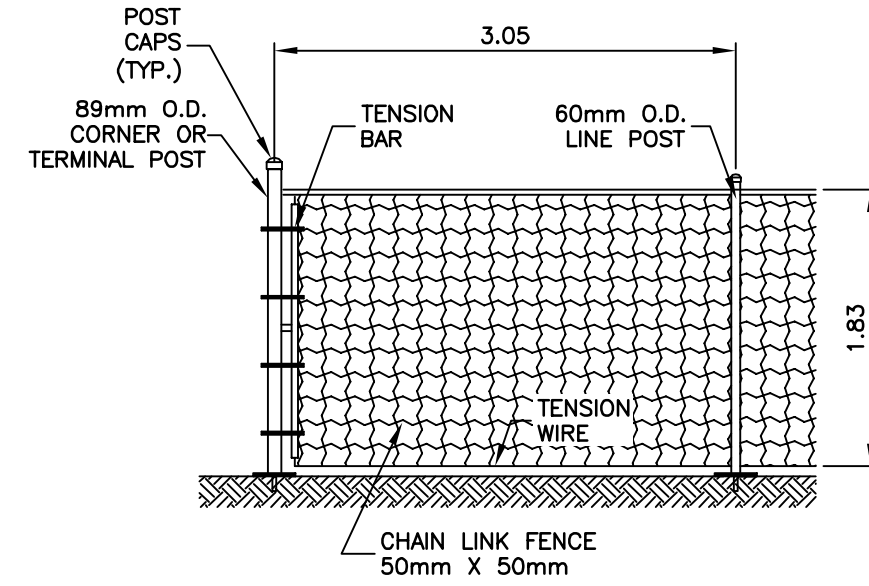

1 CORNER POST
SCALE = 1:50

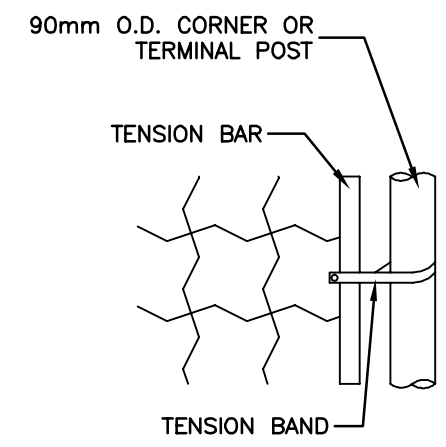

2 TENSION BAR
SCALE = 1:15

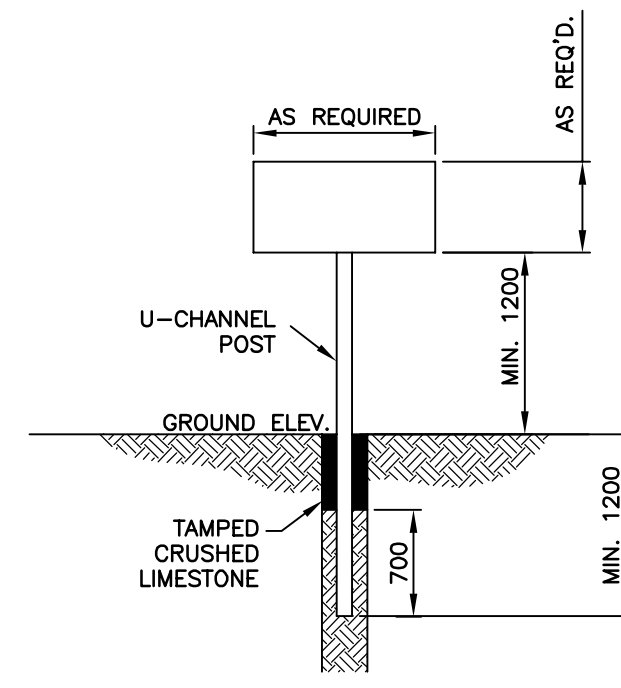

3 SIGN DETAIL
SCALE = 1:50

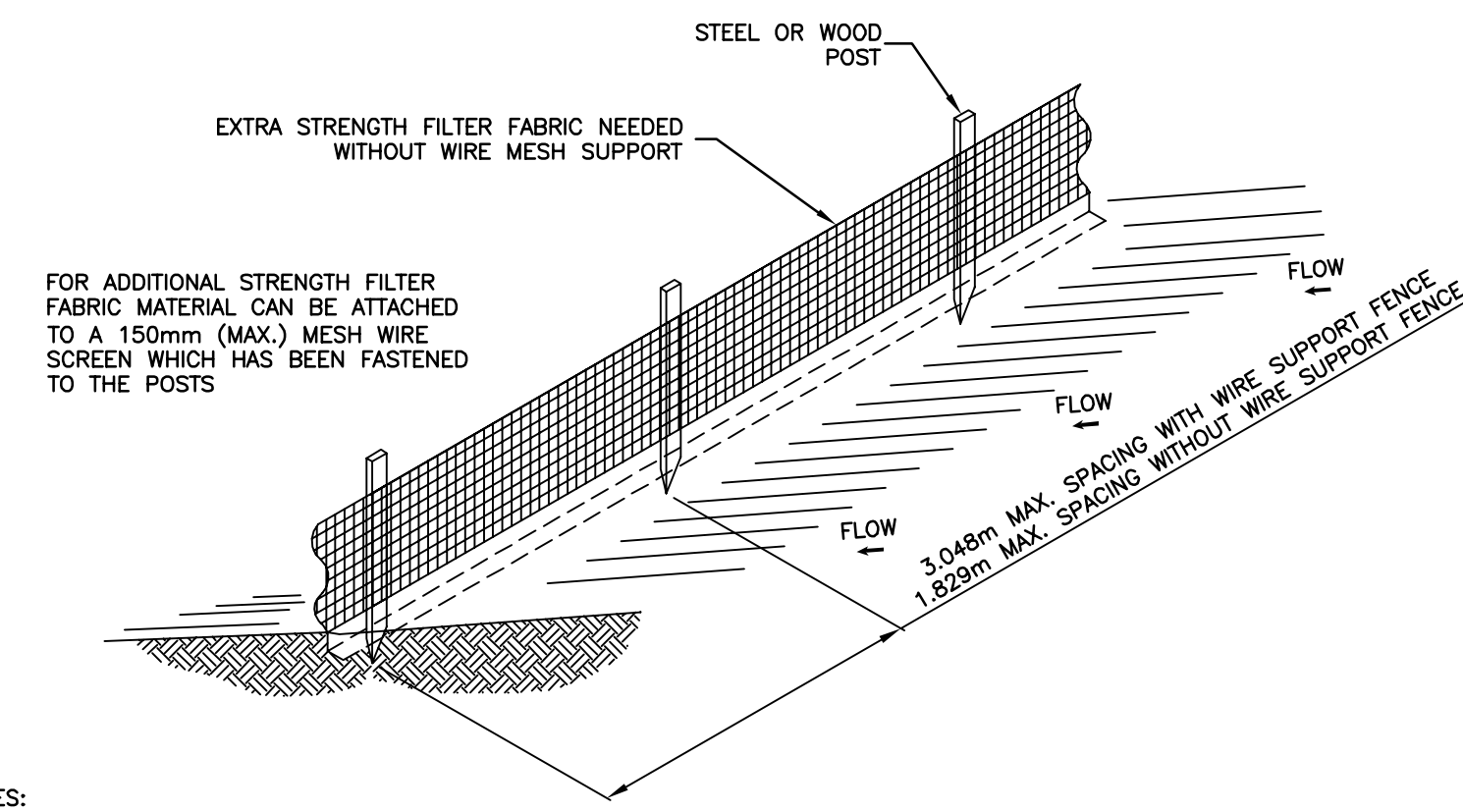

NOTES:

1. THE HEIGHT OF A SILT FENCE SHALL NOT EXCEED 914mm.
2. THE FILTER FABRIC SHALL BE PURCHASED IN A CONTINUOUS ROLL CUT TO THE LENGTH OF THE BARRIER TO AVOID THE USE OF JOINTS.
3. POSTS SHALL BE SPACED A MAXIMUM OF 3.048m APART AT THE BARRIER LOCATION AND DRIVEN SECURELY INTO THE GROUND A MINIMUM OF 300mm. WHEN EXTRA STRENGTH FABRIC IS USED WITHOUT THE WIRE SUPPORT FENCE, POST SPACING SHALL NOT EXCEED 1.829m.
4. A TRENCH SHALL BE EXCAVATED APPROXIMATELY 100mm WIDE AND 100mm DEEP ALONG THE LINE OF POSTS AND UPSLOPE FROM THE BARRIER.
5. WHEN STANDARD STRENGTH FILTER FABRIC IS USED, A WIRE MESH SUPPORT FENCE SHALL BE FASTENED SECURELY TO THE UPSLOPE SIDE OF THE POSTS USING HEAVY DUTY WIRE STAPLES AT LEAST 25mm LONG, TIE WIRES, OR HOG RINGS. THE WIRE SHALL EXTEND INTO THE TRENCH A MINIMUM OF 50mm AND SHALL NOT EXTEND MORE THAN 914mm ABOVE THE ORIGINAL GROUND SURFACE.
6. THE STANDARD STRENGTH FILTER FABRIC SHALL BE STAPLED OR WIRED TO THE FENCE, AND 200mm OF THE FABRIC SHALL BE EXTENDED INTO THE TRENCH. THE FABRIC SHALL NOT EXTEND MORE THAN 914mm ABOVE THE ORIGINAL GROUND SURFACE.
7. THE TRENCH SHALL BE BACKFILLED AND THE SOIL COMPACTED OVER THE FILTER FABRIC.
8. SILT FENCING TO BE POLYPROPYLENE SYNTHETIC FIBRE WITH ULTRAVIOLET STABILIZERS. AMOCO 1198 OR APPROVED EQUAL.
9. WOOD POSTS TO BE 38mm X 89mm (2" X 4"), POINTED AT ONE END AND FABRICATED.
10. INSTALL ALL SUPPORTING POSTS ON THE DOWN SLOPE SIDE OF THE FENCING
11. MAINTAIN SILT FENCE THROUGHOUT CONSTRUCTION AND UNTIL REVEGETATION OCCURS.

4 SILT FENCE DETAIL
SCALE = 1:40

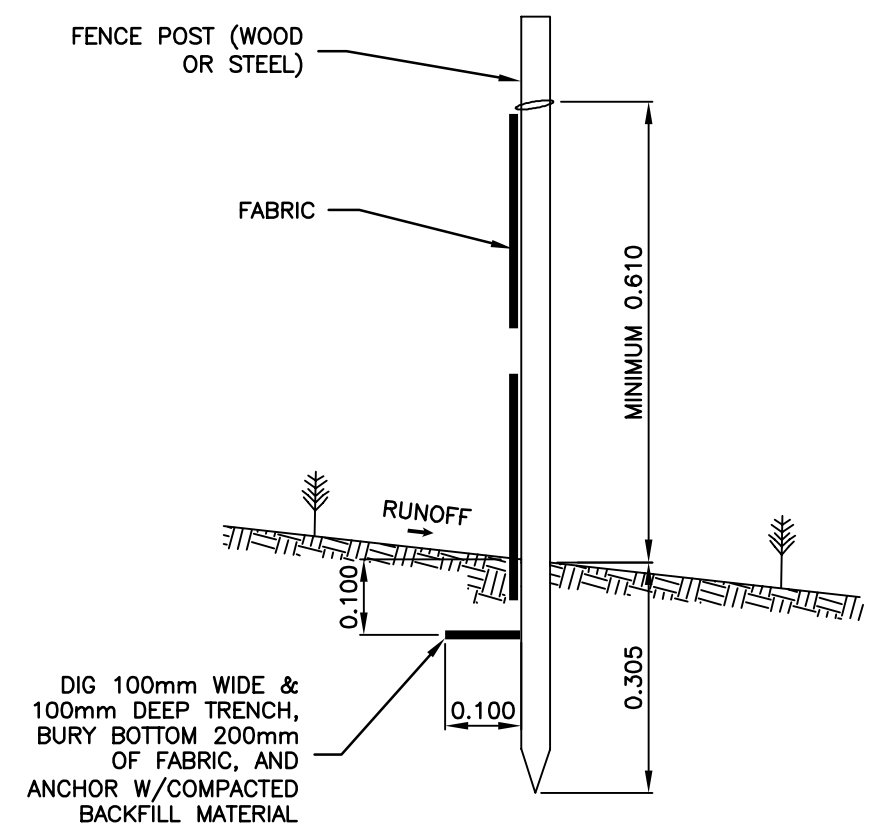

5 SILT FENCE SECTION
SCALE = 1:10

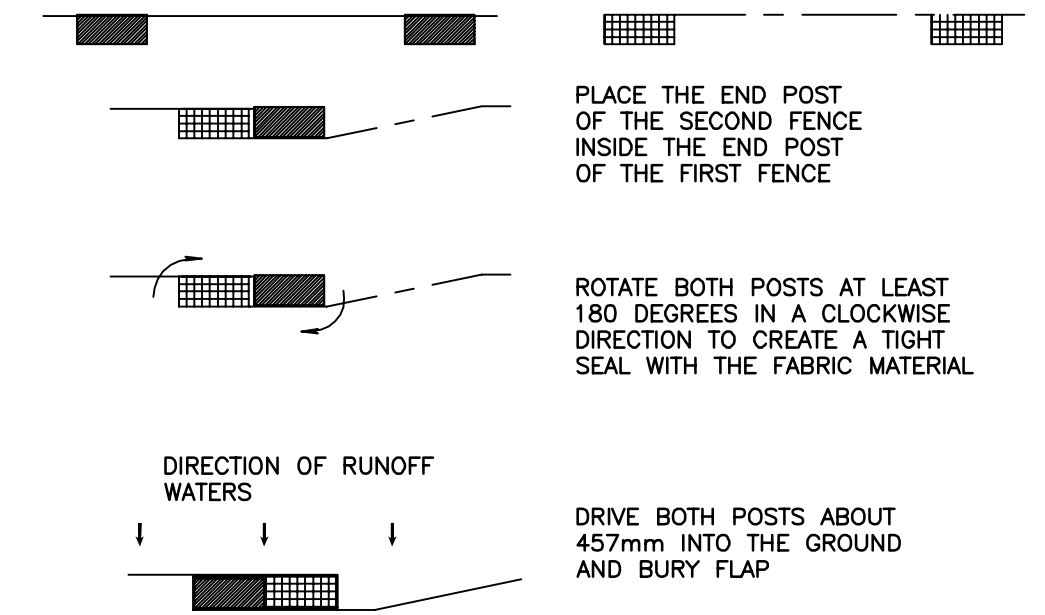

6 ATTACHING TWO SILT FENCES
SCALE = 1:10

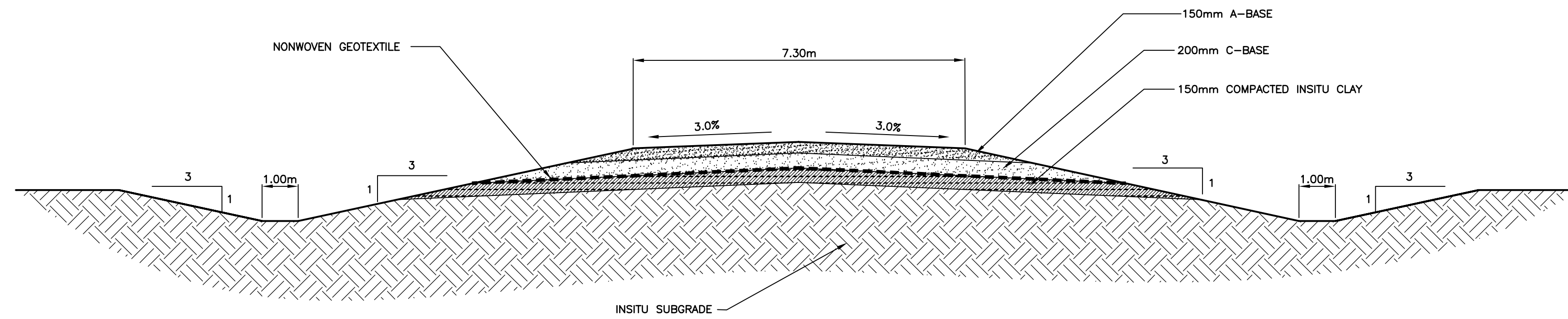

7 ACCESS ROAD CROSS-SECTION
SCALE = NTS

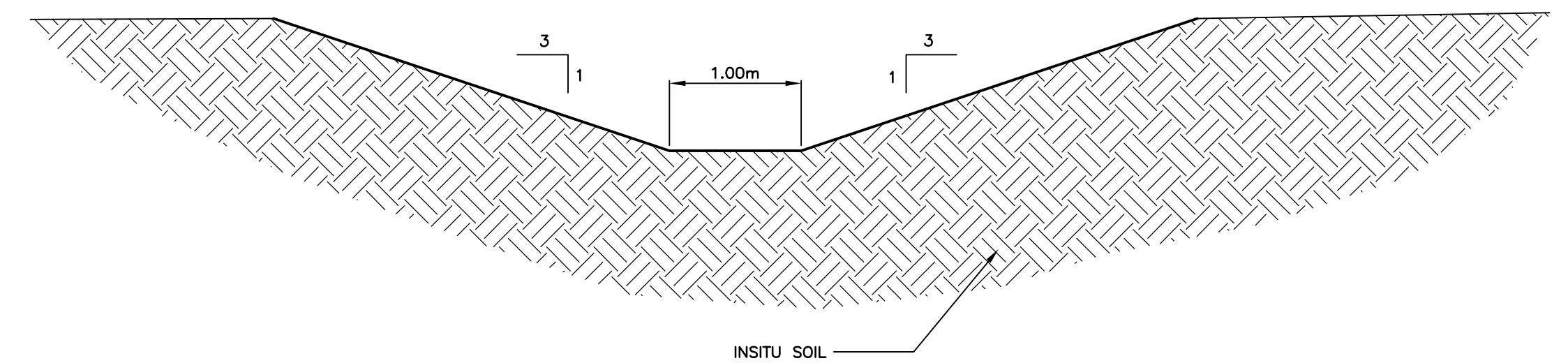

8 TYPICAL DITCH CROSS-SECTION
SCALE = NTS

PRELIMINARY
NOT FOR CONSTRUCTION

No.	REVISIONS	DATE	INITIALS	B.M. EL.

LOCATIONS OF UNDERGROUND STRUCTURES/UTILITIES AS SHOWN ARE BASED ON AVAILABLE INFORMATION BUT NO GUARANTEE IS GIVEN OR IMPLIED THAT ALL EXISTING UNDERGROUND STRUCTURES/UTILITIES ARE SHOWN OR THAT THE GIVEN LOCATIONS ARE EXACT. CONFIRMATION OF EXISTENCE AND EXACT LOCATION OF ALL UNDERGROUND STRUCTURES/UTILITIES MUST BE OBTAINED FROM THE APPROPRIATE AUTHORITY/OWNER, BY THE CONTRACTOR, BEFORE PROCEEDING WITH CONSTRUCTION.

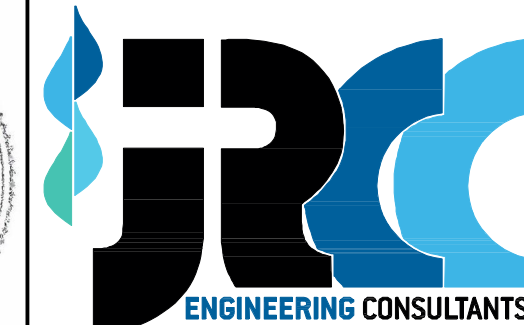
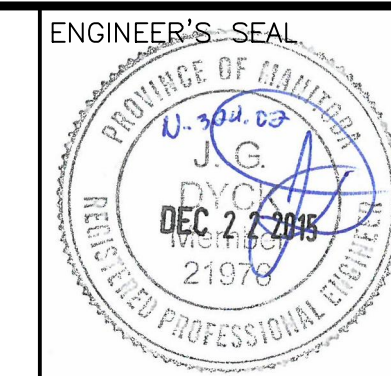

JR Cousin Consultants Ltd.
91A Scurfield Blvd. Winnipeg MB R3Y 1G4
p. (204) 489-0474
f. (204) 489-0487
www.jrcc.ca

CODE: N-324.02	PROJECT: MUNICIPAL WASTE MANAGEMENT WASTE DISPOSAL GROUND EXPANSION
DESIGNED BY: OW	TITLE: ROAD, DITCH, FENCE, SIGN AND SILT FENCE DETAILS
DRAWN BY: RH	SCALE: AS NOTED
REVIEWED BY: JD	DATE: 15/11/19
	PLAN: 5
	SHEET: 5 of 6

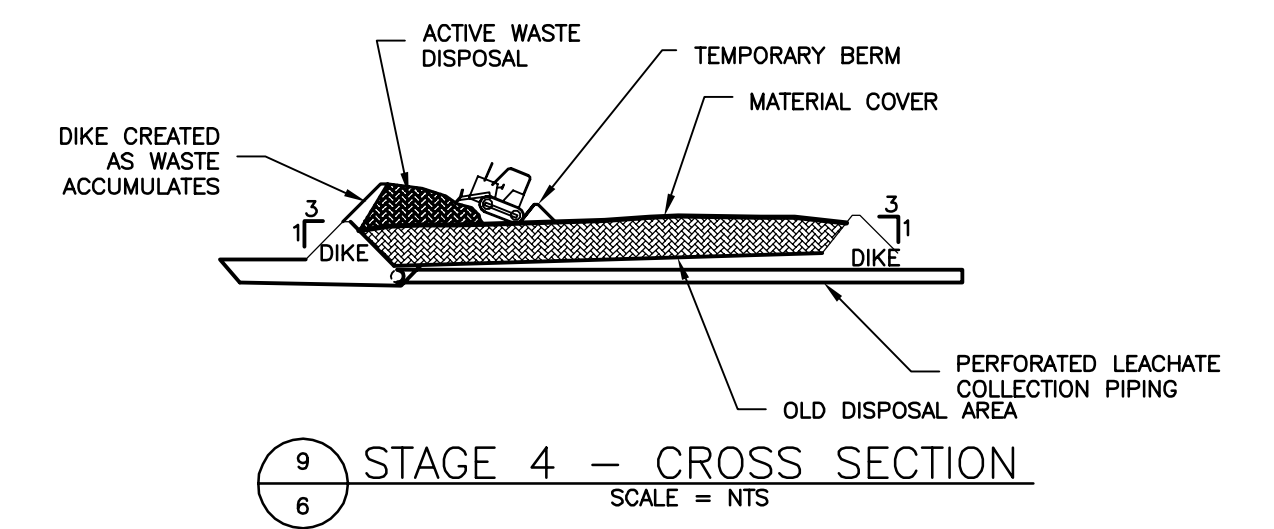
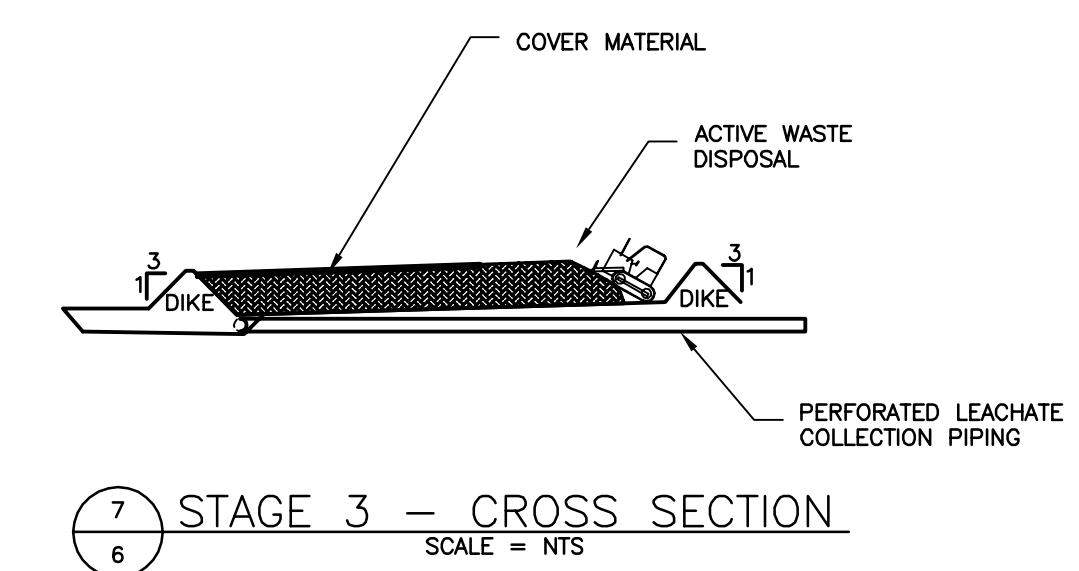
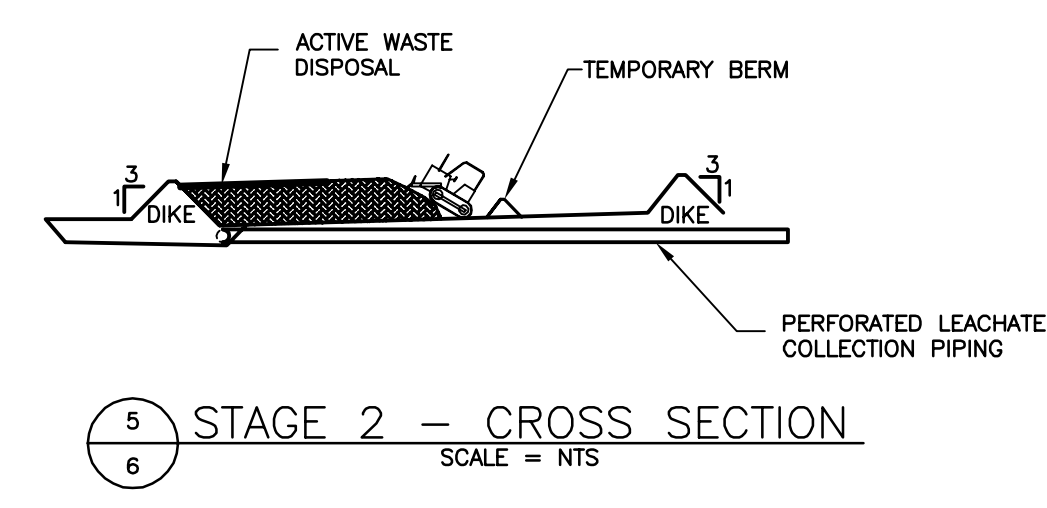
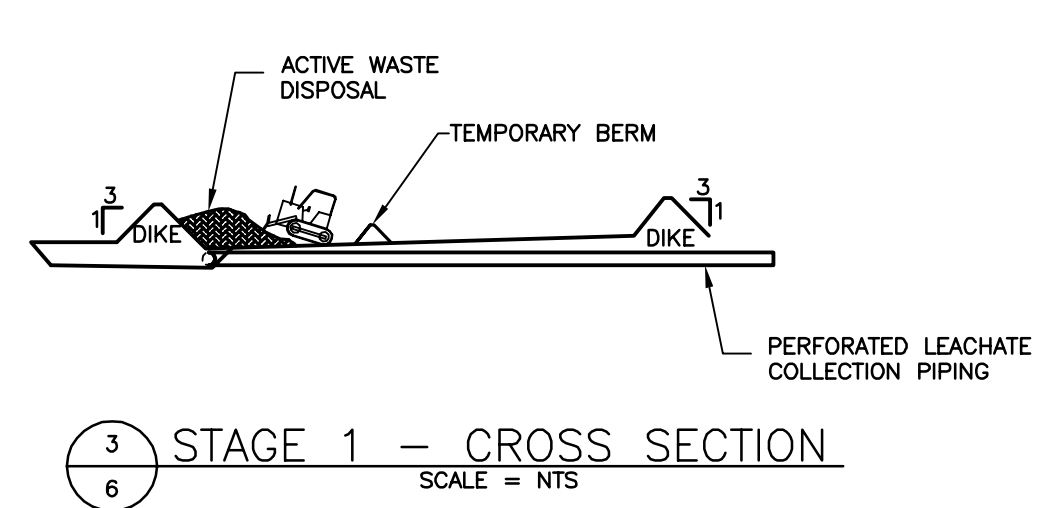
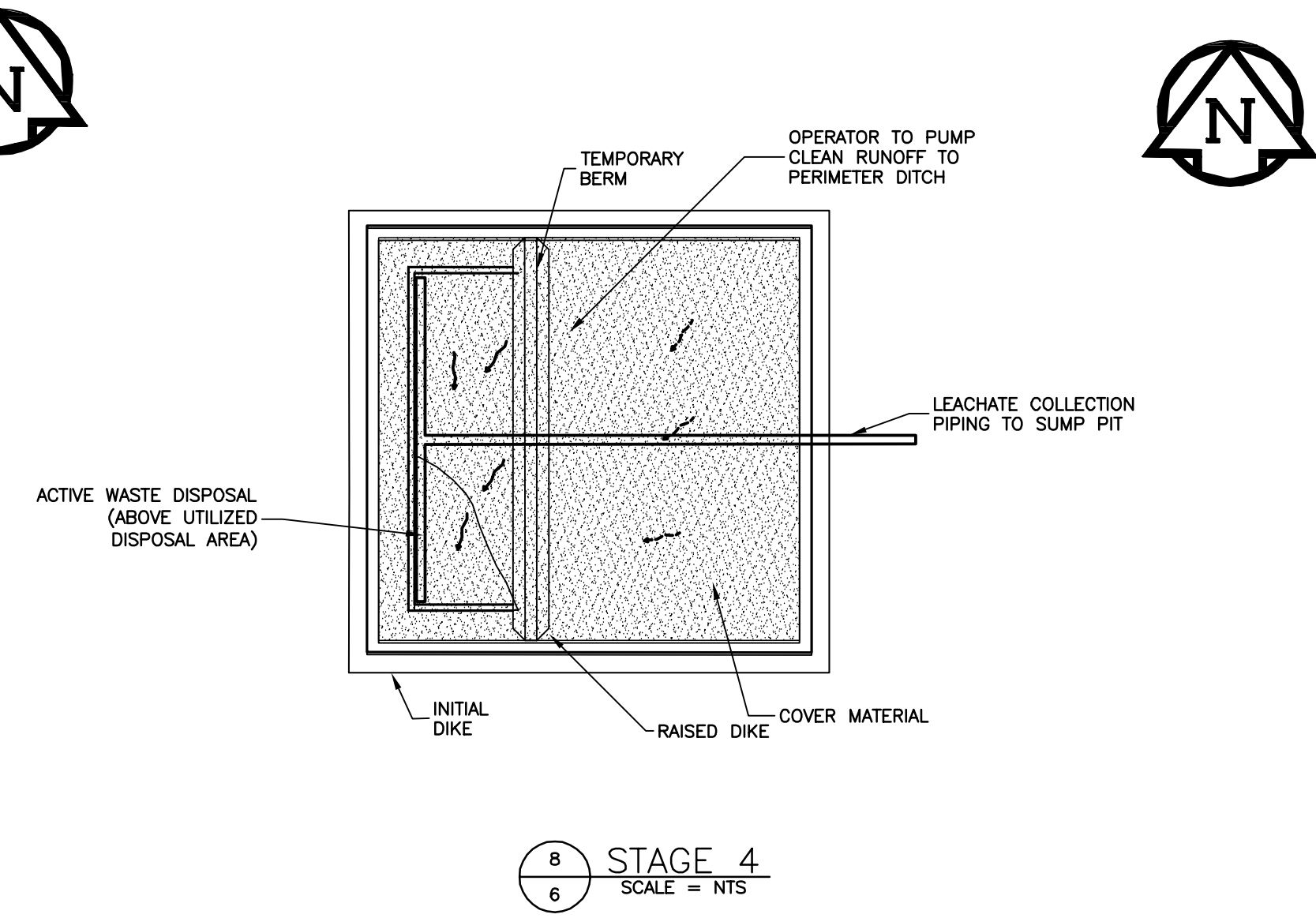
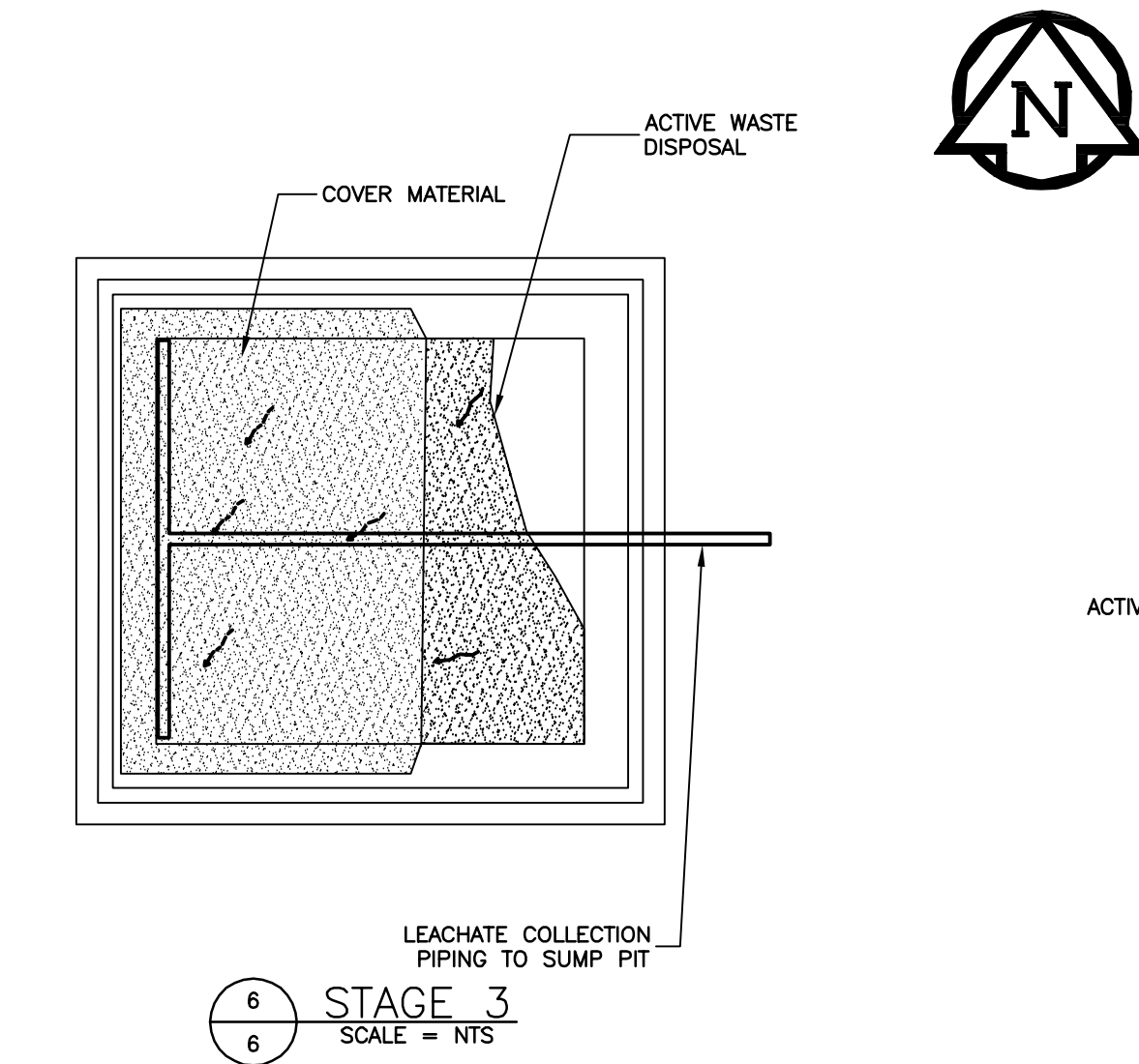
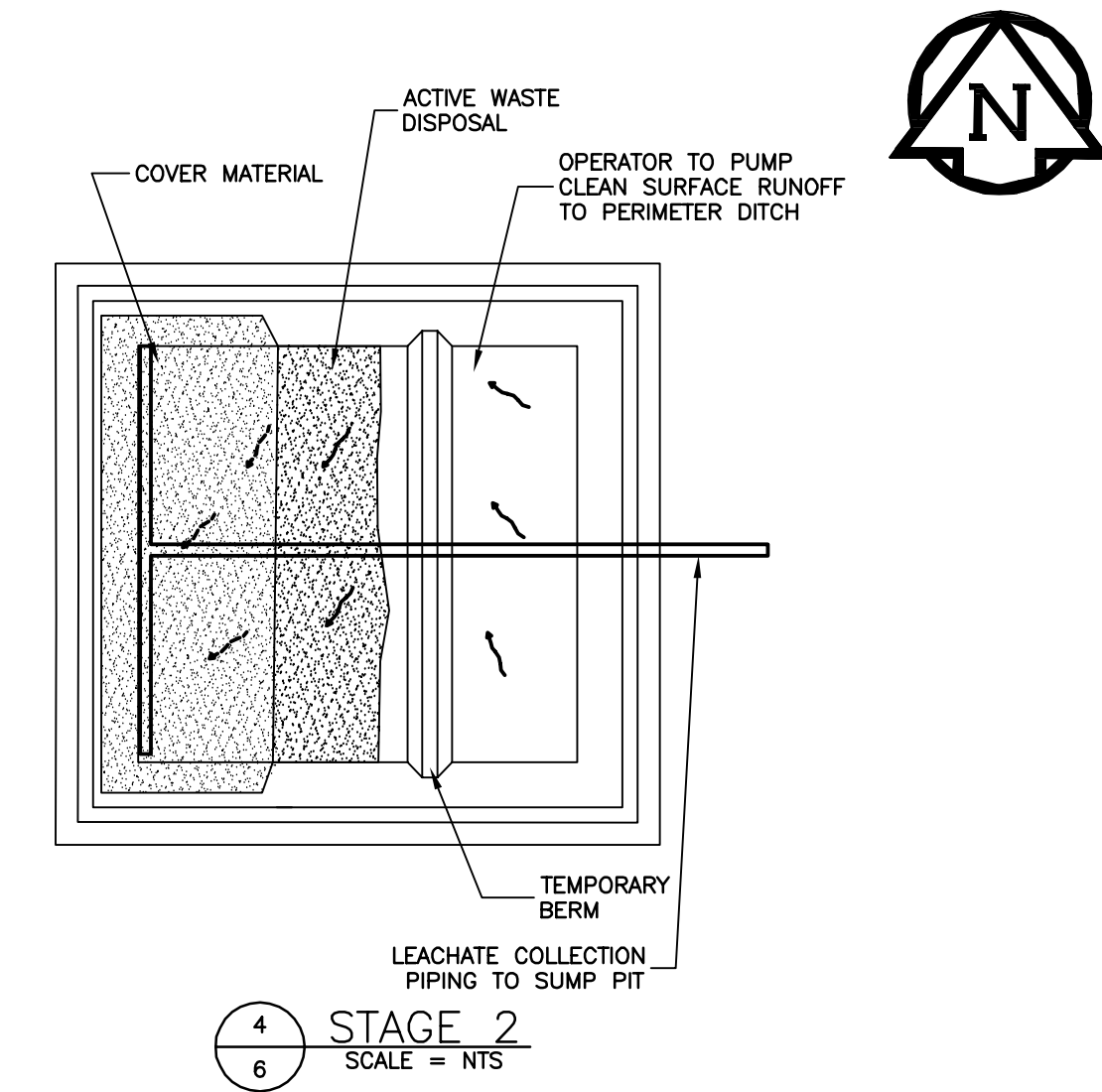
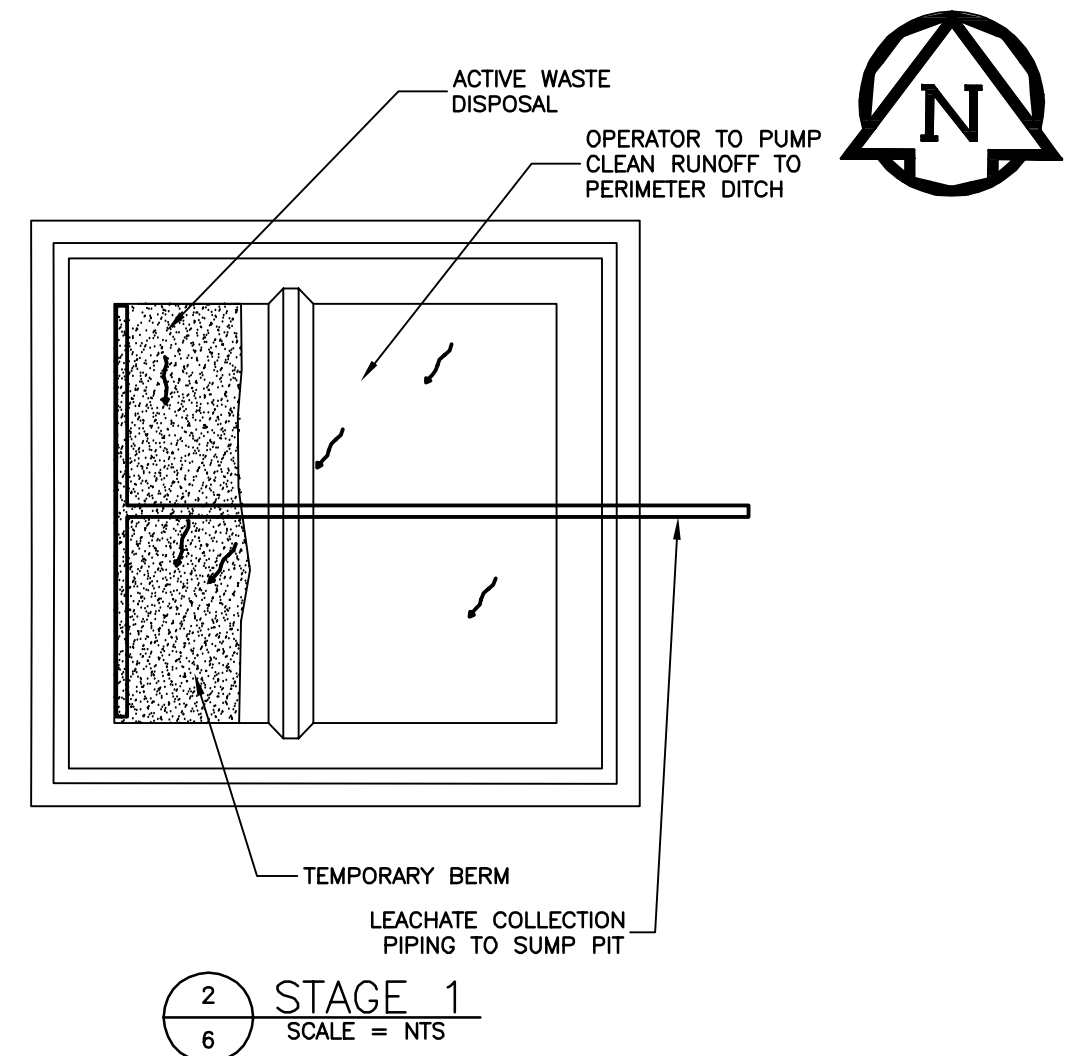
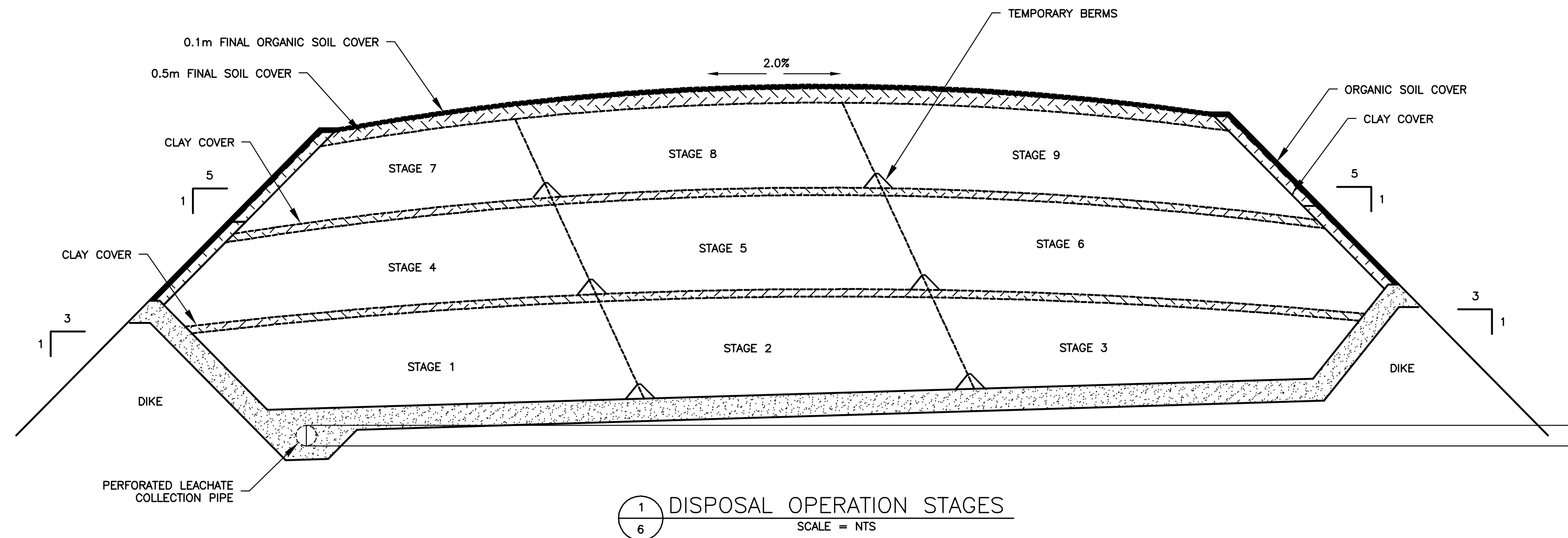

PRELIMINARY
NOT FOR CONSTRUCTION

No.	REVISIONS	DATE	INITIALS	B.M. EL.

LOCATIONS OF UNDERGROUND STRUCTURES/UTILITIES AS SHOWN ARE BASED ON AVAILABLE INFORMATION BUT NO GUARANTEE IS GIVEN OR IMPLIED THAT ALL EXISTING UNDERGROUND STRUCTURES/UTILITIES ARE SHOWN OR THAT THE GIVEN LOCATIONS ARE EXACT. CONFIRMATION OF EXISTENCE AND EXACT LOCATION OF ALL UNDERGROUND STRUCTURES/UTILITIES MUST BE OBTAINED FROM THE APPROPRIATE AUTHORITY/OWNER, BY THE CONTRACTOR, BEFORE PROCEEDING WITH CONSTRUCTION.

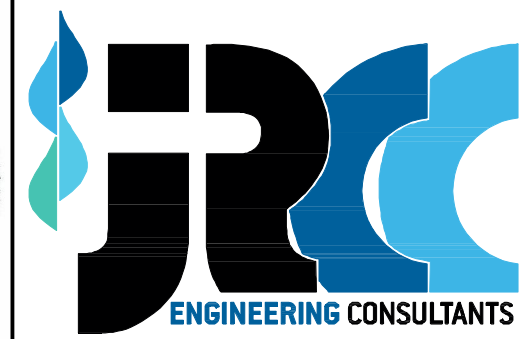
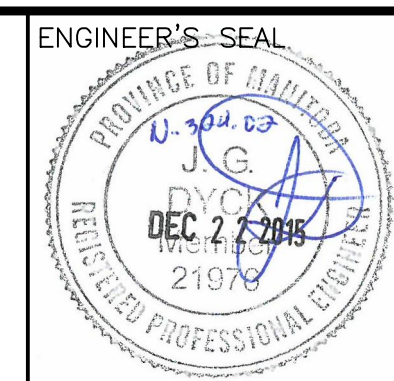

JR Cousin Consultants Ltd.
91A Scurfield Blvd. Winnipeg MB R3Y 1G4
p. (204) 489-0474
f. (204) 489-0487
www.jrcc.ca

CODE: N-324.02	PROJECT: MUNICIPAL WASTE MANAGEMENT WASTE DISPOSAL GROUND EXPANSION
DESIGNED BY: OW	TITLE: SITE OPERATIONS PLAN
DRAWN BY: RH	SCALE: AS NOTED
REVIEWED BY: JD	DATE: 15/11/19
	PLAN: 6
	SHEET: 6 of 6

Dec 27, 2019 - 10:58am P:\300\324 - 305pm P\300\324 - 305 Development Act Proposal\04 - Drawings\DWG\Site Plans - 04.dwg